

Cisco Reader Comment Card

General Information

- 1 Years of networking experience: _____ Years of experience with Cisco products: _____
2 I have these network types: [] LAN [] Backbone [] WAN [] Other: _____
3 I have these Cisco products: [] Switches [] Routers [] Other (specify models): _____
4 I perform these types of tasks: [] H/W installation and/or maintenance [] S/W configuration [] Network management [] Other: _____
5 I use these types of documentation: [] H/W installation [] H/W configuration [] S/W configuration [] Command reference [] Quick reference [] Release notes [] Online help [] Other: _____
6 I access this information through: _____% Cisco.com (CCO) _____% CD-ROM _____% Printed docs _____% Other: _____
7 I prefer this access method: _____
8 I use the following three product features the most: _____

Document Information

Document Title: Cisco 827 and SOHO 77 Routers Hardware Installation Guide

Part Number: 78-6854-02

On a scale of 1-5 (5 being the best), please let us know how we rate in the following areas:

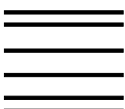
- _____ The document is written at my technical level of understanding. _____ The information is accurate.
_____ The document is complete. _____ The information I wanted was easy to find.
_____ The information is well organized. _____ The information I found was useful to my job.

Please comment on our lowest scores:

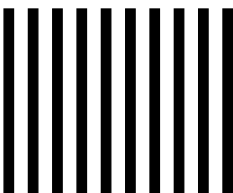
Mailing Information

Company Name _____ Date _____
Contact Name _____ Job Title _____
Mailing Address _____
City _____ State/Province _____ ZIP/Postal Code _____
Country _____ Phone () _____ Extension _____
Fax () _____ E-mail _____

Can we contact you further concerning our documentation? [] Yes [] No
You can also send us your comments by e-mail to bug-doc@cisco.com, or by fax to 408-527-8089.



NO POSTAGE
NECESSARY
IF MAILED
IN THE
UNITED STATES



BUSINESS REPLY MAIL

FIRST-CLASS MAIL PERMIT NO. 4631 SAN JOSE CA

POSTAGE WILL BE PAID BY ADDRESSEE

ATTN DOCUMENT RESOURCE CONNECTION
CISCO SYSTEMS INC
170 WEST TASMAN DRIVE
SAN JOSE CA 95134-9883





Cisco 827 and SOHO 77 Routers Hardware Installation Guide

Corporate Headquarters
Cisco Systems, Inc.
170 West Tasman Drive
San Jose, CA 95134-1706
USA
<http://www.cisco.com>
Tel: 408 526-4000
800 553-NETS (6387)
Fax: 408 526-4100

Customer Order Number: DOC-786854=
Text Part Number: 78-6854-02



THE SPECIFICATIONS AND INFORMATION REGARDING THE PRODUCTS IN THIS MANUAL ARE SUBJECT TO CHANGE WITHOUT NOTICE. ALL STATEMENTS, INFORMATION, AND RECOMMENDATIONS IN THIS MANUAL ARE BELIEVED TO BE ACCURATE BUT ARE PRESENTED WITHOUT WARRANTY OF ANY KIND, EXPRESS OR IMPLIED. USERS MUST TAKE FULL RESPONSIBILITY FOR THEIR APPLICATION OF ANY PRODUCTS.

THE SOFTWARE LICENSE AND LIMITED WARRANTY FOR THE ACCOMPANYING PRODUCT ARE SET FORTH IN THE INFORMATION PACKET THAT SHIPPED WITH THE PRODUCT AND ARE INCORPORATED HEREIN BY THIS REFERENCE. IF YOU ARE UNABLE TO LOCATE THE SOFTWARE LICENSE OR LIMITED WARRANTY, CONTACT YOUR CISCO REPRESENTATIVE FOR A COPY.

The following information is for FCC compliance of Class A devices: This equipment has been tested and found to comply with the limits for a Class A digital device, pursuant to part 15 of the FCC rules. These limits are designed to provide reasonable protection against harmful interference when the equipment is operated in a commercial environment. This equipment generates, uses, and can radiate radio-frequency energy and, if not installed and used in accordance with the instruction manual, may cause harmful interference to radio communications. Operation of this equipment in a residential area is likely to cause harmful interference, in which case users will be required to correct the interference at their own expense.

The following information is for FCC compliance of Class B devices: The equipment described in this manual generates and may radiate radio-frequency energy. If it is not installed in accordance with Cisco's installation instructions, it may cause interference with radio and television reception. This equipment has been tested and found to comply with the limits for a Class B digital device in accordance with the specifications in part 15 of the FCC rules. These specifications are designed to provide reasonable protection against such interference in a residential installation. However, there is no guarantee that interference will not occur in a particular installation.

Modifying the equipment without Cisco's written authorization may result in the equipment no longer complying with FCC requirements for Class A or Class B digital devices. In that event, your right to use the equipment may be limited by FCC regulations, and you may be required to correct any interference to radio or television communications at your own expense.

You can determine whether your equipment is causing interference by turning it off. If the interference stops, it was probably caused by the Cisco equipment or one of its peripheral devices. If the equipment causes interference to radio or television reception, try to correct the interference by using one or more of the following measures:

- Turn the television or radio antenna until the interference stops.
- Move the equipment to one side or the other of the television or radio.
- Move the equipment farther away from the television or radio.
- Plug the equipment into an outlet that is on a different circuit from the television or radio. (That is, make certain the equipment and the television or radio are on circuits controlled by different circuit breakers or fuses.)

Modifications to this product not authorized by Cisco Systems, Inc. could void the FCC approval and negate your authority to operate the product.

The Cisco implementation of TCP header compression is an adaptation of a program developed by the University of California, Berkeley (UCB) as part of UCB's public domain version of the UNIX operating system. All rights reserved. Copyright © 1981, Regents of the University of California.

NOTWITHSTANDING ANY OTHER WARRANTY HEREIN, ALL DOCUMENT FILES AND SOFTWARE OF THESE SUPPLIERS ARE PROVIDED "AS IS" WITH ALL FAULTS. CISCO AND THE ABOVE-NAMED SUPPLIERS DISCLAIM ALL WARRANTIES, EXPRESSED OR IMPLIED, INCLUDING, WITHOUT LIMITATION, THOSE OF MERCHANTABILITY, FITNESS FOR A PARTICULAR PURPOSE AND NONINFRINGEMENT OR ARISING FROM A COURSE OF DEALING, USAGE, OR TRADE PRACTICE.

IN NO EVENT SHALL CISCO OR ITS SUPPLIERS BE LIABLE FOR ANY INDIRECT, SPECIAL, CONSEQUENTIAL, OR INCIDENTAL DAMAGES, INCLUDING, WITHOUT LIMITATION, LOST PROFITS OR LOSS OR DAMAGE TO DATA ARISING OUT OF THE USE OR INABILITY TO USE THIS MANUAL, EVEN IF CISCO OR ITS SUPPLIERS HAVE BEEN ADVISED OF THE POSSIBILITY OF SUCH DAMAGES.

CCIP, CCSP, the Cisco Arrow logo, the Cisco *Powered* Network mark, the Cisco Systems Verified logo, Cisco Unity, Follow Me Browsing, FormShare, iQ Net Readiness Scorecard, Networking Academy, and ScriptShare are trademarks of Cisco Systems, Inc.; Changing the Way We Work, Live, Play, and Learn, The Fastest Way to Increase Your Internet Quotient, and iQuick Study are service marks of Cisco Systems, Inc.; and Aironet, ASIST, BPX, Catalyst, CCDA, CCDP, CCIE, CCNA, CCNP, Cisco, the Cisco Certified Internetwork Expert logo, Cisco IOS, the Cisco IOS logo, Cisco Press, Cisco Systems, Cisco Systems Capital, the Cisco Systems logo, Empowering the Internet Generation, Enterprise/Solver, EtherChannel, EtherSwitch, Fast Step, GigaStack, Internet Quotient, IOS, IP/TV, iQ Expertise, the iQ logo, LightStream, MGX, MICA, the Networkers logo, Network Registrar, *Packet*, PIX, Post-Routing, Pre-Routing, RateMUX, Registrar, SlideCast, SMARTnet, StrataView Plus, Stratm, SwitchProbe, TeleRouter, TransPath, and VCO are registered trademarks of Cisco Systems, Inc. and/or its affiliates in the U.S. and certain other countries.

All other trademarks mentioned in this document or Web site are the property of their respective owners. The use of the word partner does not imply a partnership relationship between Cisco and any other company. (0303R)



- Audience ix
- Organization ix
- Conventions x
- Related Documentation xii
- Obtaining Documentation xii
 - World Wide Web xii
 - Documentation CD-ROM xii
 - Ordering Documentation xiii
 - Documentation Feedback xiii
- Obtaining Technical Assistance xiv
 - Cisco.com xiv
 - Technical Assistance Center xiv

CHAPTER 1

Product Overview 1-1

- Features 1-2
- Router Overview 1-3
 - Front Panels 1-3
 - Back Panels 1-5
 - LEDs 1-8

CHAPTER 2

Installation 2-1

- Preparing for Installation 2-2
 - Safety 2-2
 - Unpacking the Box 2-4
- Preventing Router Damage 2-6
- Mounting the Router 2-7
 - Mounting on a Table 2-7
 - Mounting on a Wall 2-7
- Installing the Router 2-10
 - Connect Ethernet Devices 2-10
 - Connect an ADSL Line 2-15
 - Connect an Analog Telephone or Fax Machine (Cisco 827-4V Routers Only) 2-16
 - Connect a Terminal or PC to the Router's Console Port (Optional) 2-17

- Connect the AC Adapter 2-18
- Using the Router LEDs to Check Links 2-20
- Configuring the Router 2-21
 - Checking the PC Configuration 2-21
 - Using Cisco Router Web Setup to Configure the Router 2-22

CHAPTER 3

Troubleshooting 3-1

- Before You Call Your Cisco Reseller 3-1
- Problems During First Startup 3-2
- Problems After Router Is Running 3-4

APPENDIX A

Specifications and Cables A-1

- System Specifications A-1
- Port Connector Pinouts A-2
- Cabling Specifications A-6
 - Ethernet Cable Specifications A-6
 - Maximum Cable Distances A-6



Preface

This preface describes the audience for, organization of, and conventions used in this guide. It also discusses related documentation and tells how to access electronic documentation.

Audience

This guide is intended for service technicians who have no experience installing routers but whose goal is to connect routers to networks as quickly as possible.

Organization

This guide is organized as follows:

- Chapter 1, “Product Overview”—Describes the Cisco 827 and SOHO 77 routers and their features.
- Chapter 2, “Installation”—Provides information on preinstallation, mounting, connecting, and configuring the router, and verification of router connections.
- Chapter 3, “Troubleshooting”—Describes problems with the router and how to identify and solve them.
- Appendix A, “Specifications and Cables”—Provides Cisco part numbers for cables that you can order and contains port connector pinouts and specifications for cables that you might need to provide.

Conventions

This section describes the conventions used in this guide.



Note

Means *reader take note*. Notes contain helpful suggestions or references to additional information and material.



Caution

This symbol means *reader be careful*. In this situation, you might do something that could result in equipment damage or loss of data.

**Warning**

This warning symbol means danger. You are in a situation that could cause bodily injury. Before you work on any equipment, be aware of the hazards involved with electrical circuitry and be familiar with the standard practices for preventing accidents.

Waarschuwing

Dit waarschuwingssymbool betekent gevaar. U verkeert in een situatie die lichamelijk letsel kan veroorzaken. Voordat u aan enige apparatuur gaat werken, dient u zich bewust te zijn van de bij elektrische schakelingen betrokken risico's en dient u op de hoogte te zijn van standaard maatregelen om ongelukken te voorkomen.

Varoitus

Tämä varoitusmerkki merkitsee vaaraa. Olet tilanteessa, joka voi johtaa ruumiinvammaan. Ennen kuin työskentelet minkään laitteiston parissa, ota selvää sähkökytkentöihin liittyvistä vaaroista ja tavanomaisista onnettomuuksien ehkäisykeinoista.

Attention

Ce symbole d'avertissement indique un danger. Vous vous trouvez dans une situation pouvant causer des blessures ou des dommages corporels. Avant de travailler sur un équipement, soyez conscient des dangers posés par les circuits électriques et familiarisez-vous avec les procédures couramment utilisées pour éviter les accidents.

Warnung

Dieses Warnsymbol bedeutet Gefahr. Sie befinden sich in einer Situation, die zu einer Körperverletzung führen könnte. Bevor Sie mit der Arbeit an irgendeinem Gerät beginnen, seien Sie sich der mit elektrischen Stromkreisen verbundenen Gefahren und der Standardpraktiken zur Vermeidung von Unfällen bewusst.

Avvertenza

Questo simbolo di avvertenza indica un pericolo. La situazione potrebbe causare infortuni alle persone. Prima di lavorare su qualsiasi apparecchiatura, occorre conoscere i pericoli relativi ai circuiti elettrici ed essere al corrente delle pratiche standard per la prevenzione di incidenti.

Advarsel

Dette varselsymbolet betyr fare. Du befinner deg i en situasjon som kan føre til personskade. Før du utfører arbeid på utstyr, må du være oppmerksom på de faremomentene som elektriske kretser innebærer, samt gjøre deg kjent med vanlig praksis når det gjelder å unngå ulykker.

Aviso

Este símbolo de aviso indica perigo. Encontra-se numa situação que lhe poderá causar danos físicos. Antes de começar a trabalhar com qualquer equipamento, familiarize-se com os perigos relacionados com circuitos eléctricos, e com quaisquer práticas comuns que possam prevenir possíveis acidentes.

- ¡Atención!** Este símbolo de aviso significa peligro. Existe riesgo para su integridad física. Antes de manipular cualquier equipo, considerar los riesgos que entraña la corriente eléctrica y familiarizarse con los procedimientos estándar de prevención de accidentes.
- Varning!** Denna varningssymbol signalerar fara. Du befinner dig i en situation som kan leda till personskada. Innan du utför arbete på någon utrustning måste du vara medveten om farorna med elkretsar och känna till vanligt förfarande för att förebygga skador.
-

Related Documentation

In addition to this *Cisco 827 Routers and SOHO 77 Hardware Installation Guide*, the documentation for the Cisco 827 routers includes the following:

- *Cisco 820 Series and SOHO Series Router Cabling and Setup Quick Start Guide*
- *Cisco 827 Routers Software Configuration Guide*
- *Cisco 827 Routers Release Notes*
- *Software Enhancements for the Cisco 800 Routers and SOHO Routers*

Obtaining Documentation

The following sections explain how to obtain documentation from Cisco Systems.

World Wide Web

You can access the most current Cisco documentation on the World Wide Web at the following URL:

<http://www.cisco.com>

Translated documentation is available at the following URL:

http://www.cisco.com/public/countries_languages.shtml

Documentation CD-ROM

Cisco documentation and additional literature are available in a Cisco Documentation CD-ROM package, which is shipped with your product. The Documentation CD-ROM is updated monthly and may be more current than printed documentation. The CD-ROM package is available as a single unit or through an annual subscription.

Ordering Documentation

Cisco documentation is available in the following ways:

- Registered Cisco Direct Customers can order Cisco product documentation from the Networking Products MarketPlace:
http://www.cisco.com/cgi-bin/order/order_root.pl
- Registered Cisco.com users can order the Documentation CD-ROM through the online Subscription Store:
<http://www.cisco.com/go/subscription>
- Nonregistered Cisco.com users can order documentation through a local account representative by calling Cisco corporate headquarters (California, USA) at 408 526-7208 or, elsewhere in North America, by calling 800 553-NETS (6387).

Documentation Feedback

If you are reading Cisco product documentation on Cisco.com, you can submit technical comments electronically. Click **Leave Feedback** at the bottom of the Cisco Documentation home page. After you complete the form, print it out and fax it to Cisco at 408 527-0730.

You can e-mail your comments to bug-doc@cisco.com.

To submit your comments by mail, use the response card behind the front cover of your document, or write to the following address:

Cisco Systems
Attn: Document Resource Connection
170 West Tasman Drive
San Jose, CA 95134-9883

We appreciate your comments.

Obtaining Technical Assistance

Cisco provides Cisco.com as a starting point for all technical assistance. Customers and partners can obtain documentation, troubleshooting tips, and sample configurations from online tools by using the Cisco Technical Assistance Center (TAC) Web Site. Cisco.com registered users have complete access to the technical support resources on the Cisco TAC Web Site.

Cisco.com

Cisco.com is the foundation of a suite of interactive, networked services that provides immediate, open access to Cisco information, networking solutions, services, programs, and resources at any time, from anywhere in the world.

Cisco.com is a highly integrated Internet application and a powerful, easy-to-use tool that provides a broad range of features and services to help you to

- Streamline business processes and improve productivity
- Resolve technical issues with online support

- Download and test software packages
- Order Cisco learning materials and merchandise
- Register for online skill assessment, training, and certification programs

You can self-register on Cisco.com to obtain customized information and service. To access Cisco.com, go to the following URL:

<http://www.cisco.com>

Technical Assistance Center

The Cisco TAC is available to all customers who need technical assistance with a Cisco product, technology, or solution. Two types of support are available through the Cisco TAC: the Cisco TAC Web Site and the Cisco TAC Escalation Center.

Inquiries to Cisco TAC are categorized according to the urgency of the issue:

- Priority level 4 (P4)—You need information or assistance concerning Cisco product capabilities, product installation, or basic product configuration.
- Priority level 3 (P3)—Your network performance is degraded. Network functionality is noticeably impaired, but most business operations continue.
- Priority level 2 (P2)—Your production network is severely degraded, affecting significant aspects of business operations. No workaround is available.
- Priority level 1 (P1)—Your production network is down, and a critical impact to business operations will occur if service is not restored quickly. No workaround is available.

Which Cisco TAC resource you choose is based on the priority of the problem and the conditions of service contracts, when applicable.

Cisco TAC Web Site

The Cisco TAC Web Site allows you to resolve P3 and P4 issues yourself, saving both cost and time. The site provides around-the-clock access to online tools, knowledge bases, and software. To access the Cisco TAC Web Site, go to the following URL:

<http://www.cisco.com/tac>

All customers, partners, and resellers who have a valid Cisco services contract have complete access to the technical support resources on the Cisco TAC Web Site. The Cisco TAC Web Site requires a Cisco.com login ID and password. If you have a valid service contract but do not have a login ID or password, go to the following URL to register:

<http://www.cisco.com/register/>

If you cannot resolve your technical issues by using the Cisco TAC Web Site, and you are a Cisco.com registered user, you can open a case online by using the TAC Case Open tool at the following URL:

<http://www.cisco.com/tac/caseopen>

If you have Internet access, it is recommended that you open P3 and P4 cases through the Cisco TAC Web Site.

Cisco TAC Escalation Center

The Cisco TAC Escalation Center addresses issues that are classified as priority level 1 or priority level 2; these classifications are assigned when severe network degradation significantly impacts business operations. When you contact the TAC Escalation Center with a P1 or P2 problem, a Cisco TAC engineer will automatically open a case.

To obtain a directory of toll-free Cisco TAC telephone numbers for your country, go to the following URL:

<http://www.cisco.com/warp/public/687/Directory/DirTAC.shtml>

Before calling, please check with your network operations center to determine the level of Cisco support services to which your company is entitled; for example, SMARTnet, SMARTnet Onsite, or Network Supported Accounts (NSA). In addition, please have available your service agreement number and your product serial number.



Product Overview

The Cisco 827 and SOHO 77 routers can connect a corporate telecommuter or small office to an Internet service provider (ISP) over asymmetric digital subscriber line (ADSL) lines to the following types of networks:

- Corporate LANs
- Internet

The routers are capable of bridging and multiprotocol routing between LAN and WAN ports.

Features

Table 1-1 summarizes the features of the Cisco 827 series and SOHO 77 series routers.

Table 1-1 Cisco 827 and SOHO 77 Routers Features Summary

Feature	Routers	Description
10BASE-T Ethernet port(s)	All	Provides connection to 10BASE-T (10-Mbps) Ethernet networks. Compatible with 10/100-Mbps devices.
ADSL port	All	Provides connection to ADSL network.
Telephone ports	Cisco 827-4V	Provides connection to telephone or fax machine connected to telephone services through ADSL line.
Flash memory	<ul style="list-style-type: none"> • Cisco 827-4V • Cisco 827H • Cisco 827 • SOHO 77H • SOHO 77 	<ul style="list-style-type: none"> • 12 MB of Flash memory. • 12 MB of Flash memory. • 12 MB of Flash memory. • 8 MB of Flash memory. • 8 MB of Flash memory.
Dynamic RAM (DRAM)	<ul style="list-style-type: none"> • Cisco 827-4V • Cisco 827H • Cisco 827 • SOHO 77H • SOHO 77 	<ul style="list-style-type: none"> • 16 MB of DRAM and 8-MB DIMM card. • 16 MB of DRAM. Supports 4-, 8-, or 16-MB DIMMS. • 16 MB of DRAM. • 16 MB of DRAM. • 16 MB of DRAM.
Ease of installation	All	Color-coded ports and cables to reduce the chance of error.
Cisco IOS software	All	Supports Cisco IOS software.
Cisco Router Web Setup	All	Provides a web-based software tool for basic configurations.
Console port	All	Provides connection to terminal or PC for troubleshooting and for software configuration using command-line interface.
Cable lockable	<ul style="list-style-type: none"> • Cisco 827-4V • Cisco 827 • SOHO 77 	Provides complementary feature for physically securing router.
Locking power connector	All	Locks power connector in place.
Wall-mounting feature	All	Brackets on router bottom provide for mounting the router on a wall or vertical surface.

Router Overview

Table 1-2 tells how many Ethernet and telephone ports each Cisco 827 router and SOHO 77 router has.

Table 1-2 Router Ports

Router	Ethernet Ports	Telephone Ports
Cisco 827-4V	1	4
Cisco 827H	4	0
Cisco 827	1	0
SOHO 77H	4	0
SOHO 77	1	0

Front Panels

Figure 1-1 through Figure 1-3 show the front panels of the Cisco 827 routers.

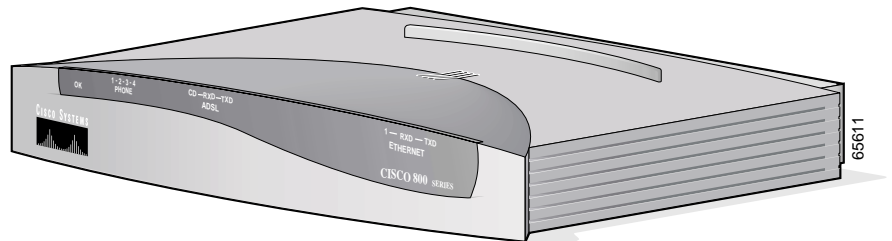
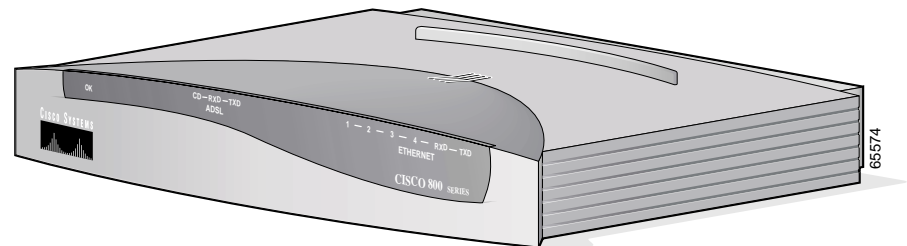
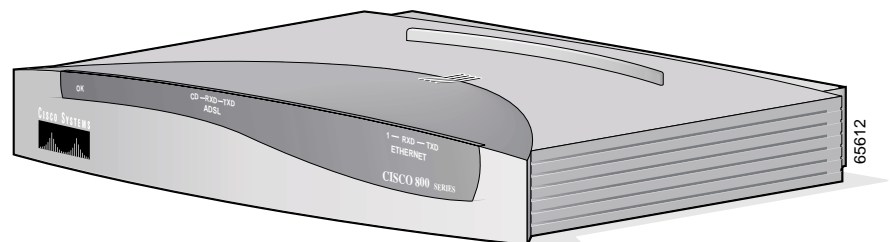
Figure 1-1 Cisco 827-4V Front Panel**Figure 1-2 Cisco 827H Front Panel****Figure 1-3 Cisco 827 Front Panel**

Figure 1-4 and Figure 1-5 show the front panels of the SOHO 77 routers.

Figure 1-4 SOHO 77H Front Panel

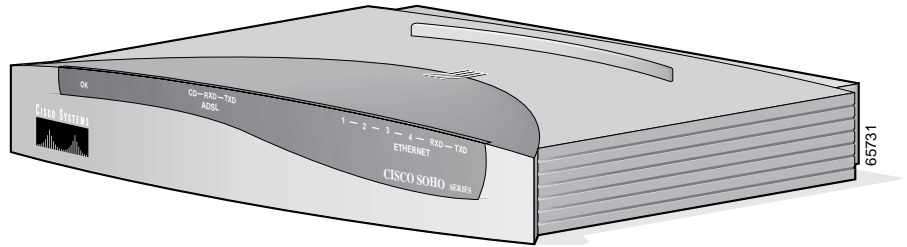
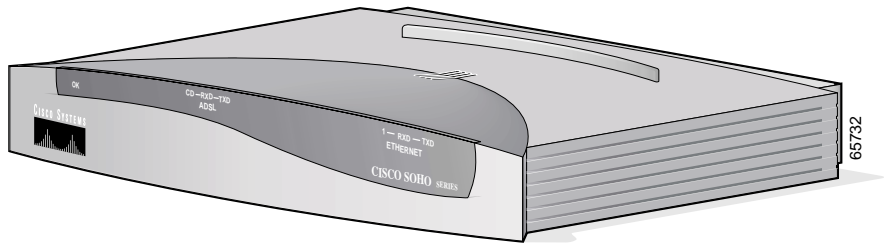


Figure 1-5 SOHO 77 Front Panel



Back Panels

Figure 1-6 through Figure 1-8 show the back panels of the Cisco 827 routers.

Figure 1-6 Cisco 827-4V Back Panel

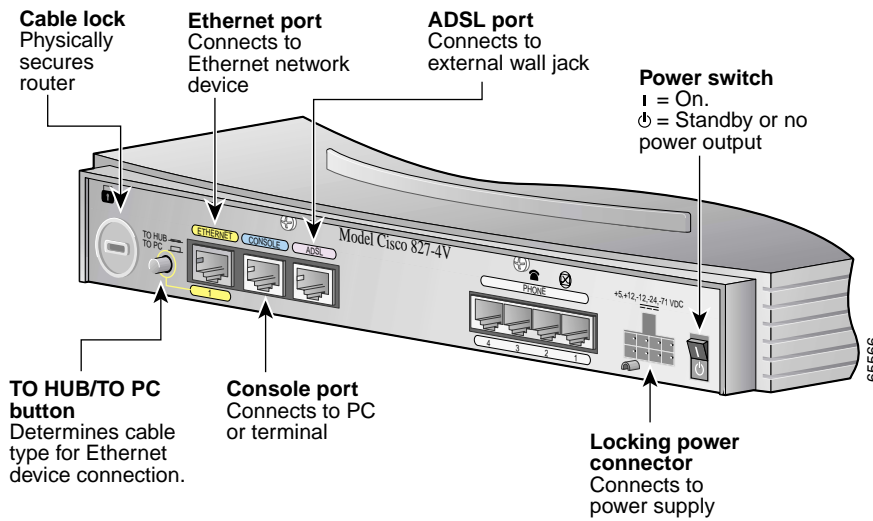


Figure 1-7 Cisco 827H Back Panel

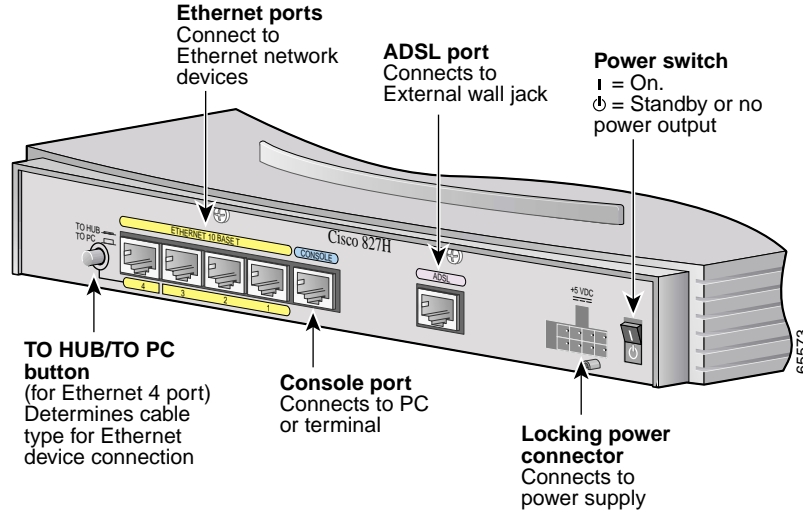


Figure 1-8 Cisco 827 Back Panel

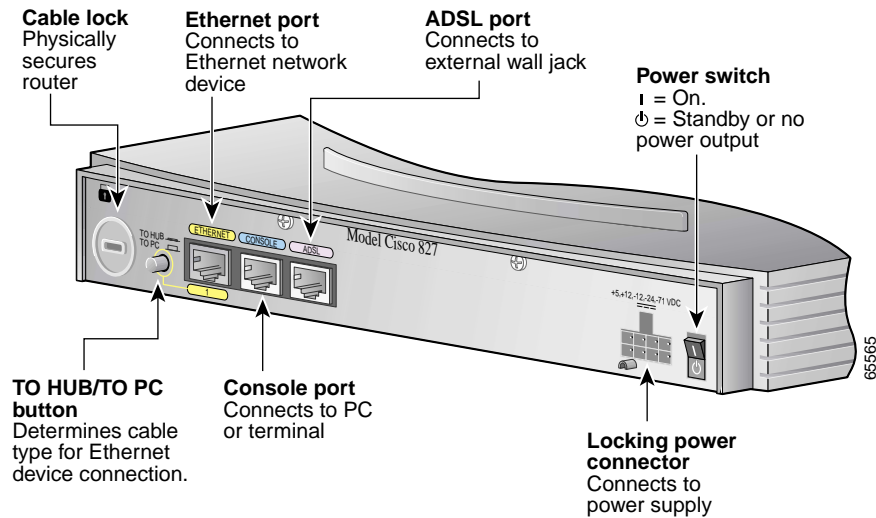


Figure 1-9 and Figure 1-10 show the back panels of the SOHO 77 routers.

Figure 1-9 SOHO 77H Back Panel

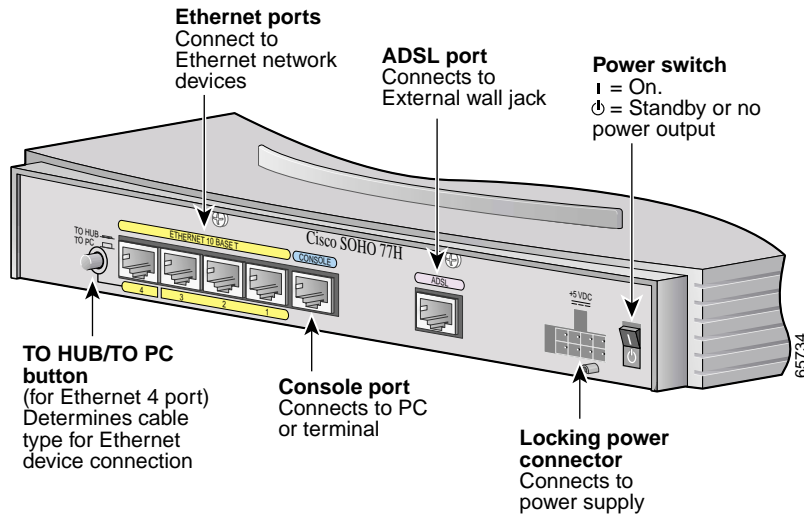
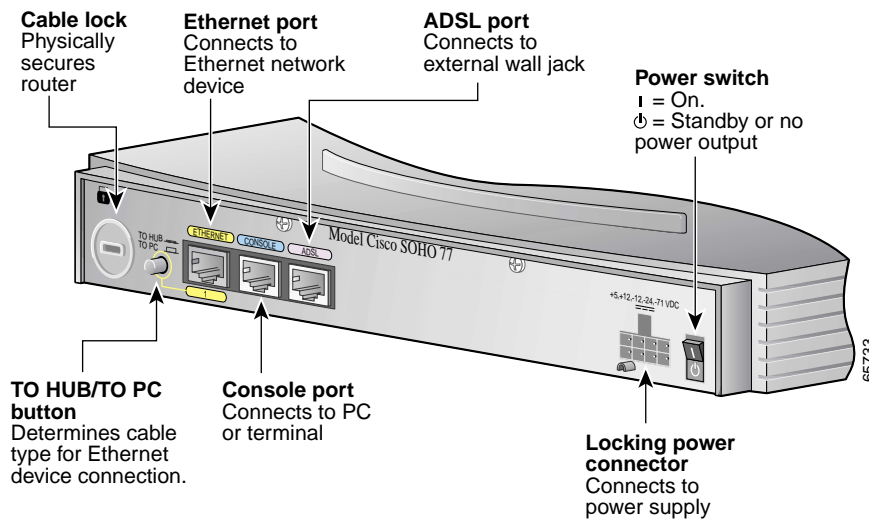


Figure 1-10 SOHO 77 Back Panel



LEDs

Table 1-3 summarizes the functions of the LEDs on the Cisco 827-4V router.

Table 1-3 LED Functions on Cisco 827-4V Router

LED	Color	Function
OK LED	Green	On when power is supplied to the router and when the router completes the self-test procedure and begins operating.
PHONE 1, 2, 3, 4	Green	On when basic telephone service is in use.

Table 1-3 LED Functions on Cisco 827-4V Router (continued)

LED	Color	Function
ADSL CD	Green	On when the ADSL device is physically connected. Blinks when the connection has a problem. See Chapter 3, “Troubleshooting.”
ADSL RXD	Green	Blinks when an ADSL port receives data.
ADSL TXD	Green	Blinks when an ADSL port sends data.
ETHERNET 1	Green	On when Ethernet device is connected. Blinks when the connection has a problem. See Chapter 3, “Troubleshooting.”
ETHERNET RXD	Green	Blinks when an Ethernet port receives a packet.
ETHERNET TXD	Green	Blinks when an Ethernet port sends a packet.

Table 1-4 summarizes the function of the LEDs on the Cisco 827H router and the SOHO 77H router.

Table 1-4 Functions of LEDs on the Cisco 827H Router and SOHO 77H Router

LED	Color	Function
OK LED	Green	On when power is supplied to the router and when the router completes the self-test procedure and begins operating.
ADSL CD	Green	On when the ADSL device is physically connected. Blinks when the connection has a problem. See Chapter 3, “Troubleshooting.”
ADSL RXD	Green	Blinks when the ADSL port receives data.
ADSL TXD	Green	Blinks when the ADSL port sends data.
ETHERNET 1, 2, 3, 4	Green	On when Ethernet device is connected. Blinks when the connection has a problem. See Chapter 3, “Troubleshooting.”
ETHERNET RXD	Green	Blinks when an Ethernet port receives a packet.
ETHERNET TXD	Green	Blinks when an Ethernet port sends a packet.

Table 1-5 summarizes the function of the LEDs on the Cisco 827 router and SOHO 77 router.

Table 1-5 LED Functions on Cisco 827 Router and SOHO 77 Router

LED	Color	Function
OK LED	Green	On when power is supplied to the router and when the router completes the self-test procedure and begins operating.
ADSL CD	Green	On when the ADSL device is physically connected. Blinks when the connection has a problem. See Chapter 3, “Troubleshooting.”
ADSL RXD	Green	Blinks when an ADSL port receives data.
ADSL TXD	Green	Blinks when an ADSL port sends data.
ETHERNET 1	Green	On when Ethernet device is connected. Blinks when the connection has a problem. See Chapter 3, “Troubleshooting.”
ETHERNET RXD	Green	Blinks when an Ethernet port receives a packet.
ETHERNET TXD	Green	Blinks when an Ethernet port sends a packet.



Installation

This chapter provides information on the following topics:

- Preparing for Installation
- Preventing Router Damage
- Mounting the Router
- Installing the Router
- Using the Router LEDs to Check Links
- Configuring the Router

Preparing for Installation

This section provides information on safety, mounting the router, and unpacking the contents of the router box.

Safety

This section provides safety warnings and electrostatic and router damage information for the Cisco 827 routers and SOHO 77 routers.

Warnings

Before installing the router, read the following warnings:



Warning

Only trained and qualified personnel should be allowed to install or replace this equipment.



Warning

Read the installation instructions before you connect the system to its power source.



Warning

Before working on a system that has a standby/off switch, turn the power to standby and unplug the power cord.



Warning

Before working on equipment that is connected to power lines, remove jewelry (including rings, necklaces, and watches). Metal objects will heat up when connected to power and ground and can cause serious burns or weld the metal object to the terminals.



Warning

To avoid electric shock, do not connect safety extra-low voltage (SELV) circuits to telephone-network voltage (TNV) circuits. LAN ports contain SELV circuits, and WAN ports contain TNV circuits. Some LAN and WAN ports both use RJ-45 connectors. Use caution when connecting cables.



Warning

Ultimate disposal of this product should be handled according to all national laws and regulations.



Warning

If the symbol of suitability with an overlaid cross (⊗) appears above a port, you must not connect the port to a public network that follows the European Union standards. Connecting the port to this type of public network can cause severe injury or damage your router.

Preventing Electrostatic Discharge Damage

Electrostatic discharge (ESD) is a transfer of electrostatic charge between bodies of different electrostatic potentials, such as an operator and a piece of electrical equipment. It occurs when electronic components are improperly handled, and it can damage equipment and impair electrical circuitry. Electrostatic discharge is more likely to occur with the combination of synthetic fibers and dry atmosphere.

Always use the following ESD-prevention procedures when removing and replacing components:

Step 1

Wear an ESD-preventive wrist strap that you provide, ensuring that it makes good skin contact.



Caution

To properly guard against ESD damage and shocks, the wrist strap and cord must operate effectively. Always observe the warnings in the preceding section, “Safety.”

Step 2

Do not touch any exposed contact pins or connector shells of interface ports that do not have a cable attached.

If cables are connected at one end only, do not touch the exposed pins at the unconnected end of the cable.



Note

This device is intended for use in residential and commercial environments only.



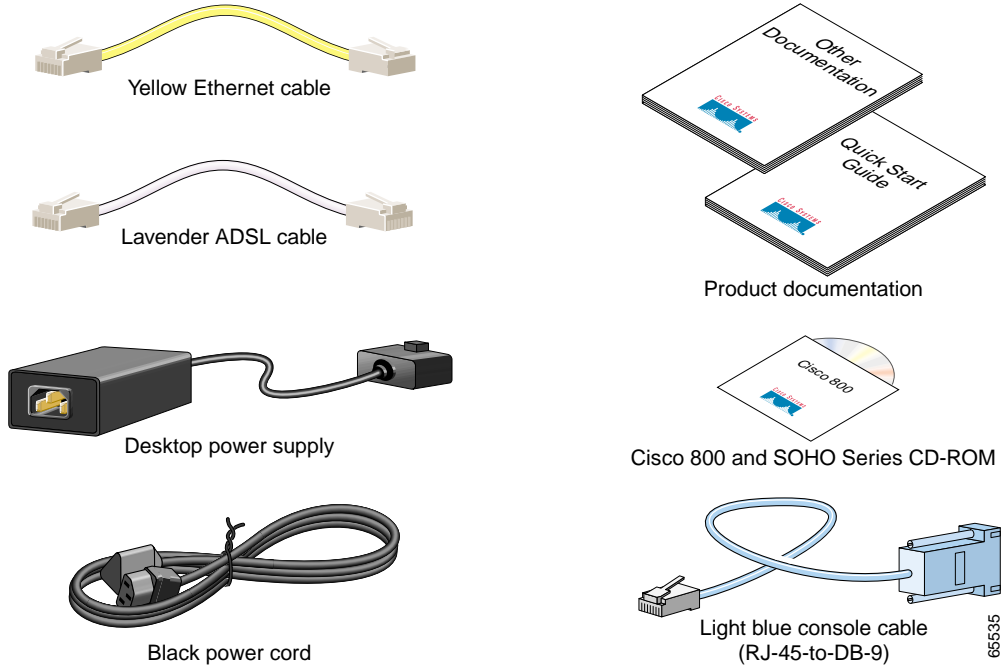
Caution

Periodically check the resistance value of the antistatic strap, which should be between 1 and 10 megohms (Mohms).

Unpacking the Box

Figure 2-1 shows the items included with your router. If any of the items is missing or damaged, contact your customer service representative.

Figure 2-1 Items Included with Router



To prepare for installation, follow these steps:

-
- Step 1** Obtain the ADSL line.
- Step 2** Remove the yellow Ethernet cable, light blue console cable, lavender ADSL cable, product documentation, and Cisco 800 Documentation CD-ROM from the Open Me First bag. Remove the desktop power supply and the black power cord from the accessory kit. Gather the Ethernet devices to be connected to the router: hub, server, workstation, or PC.
- Step 3** If you plan to connect an analog telephone or fax machine, gather these devices. You must also provide the telephone cable to connect each device (this cable is usually provided with the device).
- Step 4** If you plan to configure the software using a terminal or PC connected to the router, provide the terminal or PC.
- Step 5** If you plan to use the cable lock feature available on the Cisco 827, SOHO 77, and Cisco 827-4V routers, you must provide a Kensington or equivalent locking cable.
-

Preventing Router Damage

Follow these guidelines when connecting devices to your router:

- Connect the color-coded cables supplied by Cisco Systems to the color-coded ports on the back panel.
- If you must supply your own cable, see Appendix A, “Specifications and Cables,” for cabling specifications. If this appendix does not provide specifications for a particular cable, we strongly recommend ordering the cable from Cisco Systems.

- If the symbol of suitability (☒) appears above a port, you can connect the port directly to a public network that follows the European Union standards.

**Warning**

If the symbol of suitability with an overlaid cross (☒) appears above a port, you must not connect the port to a public network that follows the European Union standards. Connecting the port to this type of public network can cause severe injury or damage to your router.

Mounting the Router

You can mount the router on one of the following surfaces:

- Table or other horizontal surface
- Wall or other vertical surface

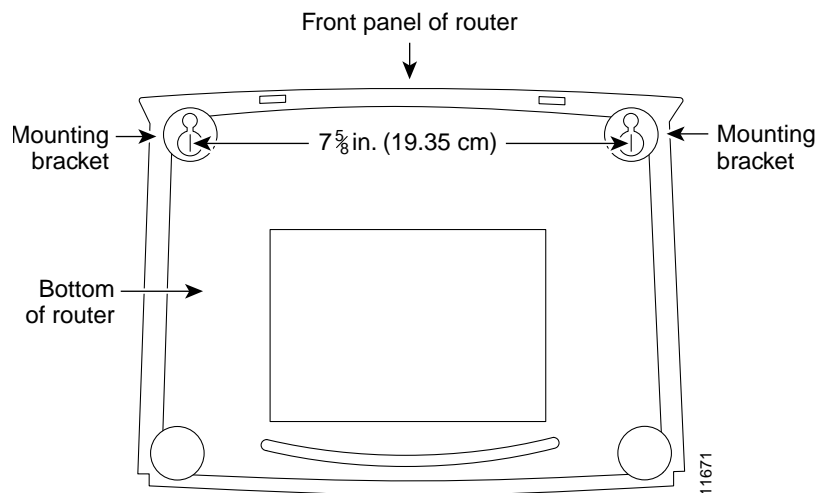
Mounting on a Table

Do not cover or obstruct the router vents, which are located on the sides of the router.

Mounting on a Wall

You can mount the router on a wall or other vertical surface by using the molded mounting brackets on the bottom of the router and two number-six, 3/4-in. (M3.5 x 20 mm) screws. You must provide the screws. Figure 2-2 shows the mounting brackets.

Figure 2-2 Wall-Mounting Brackets (Bottom of Router)



Caution

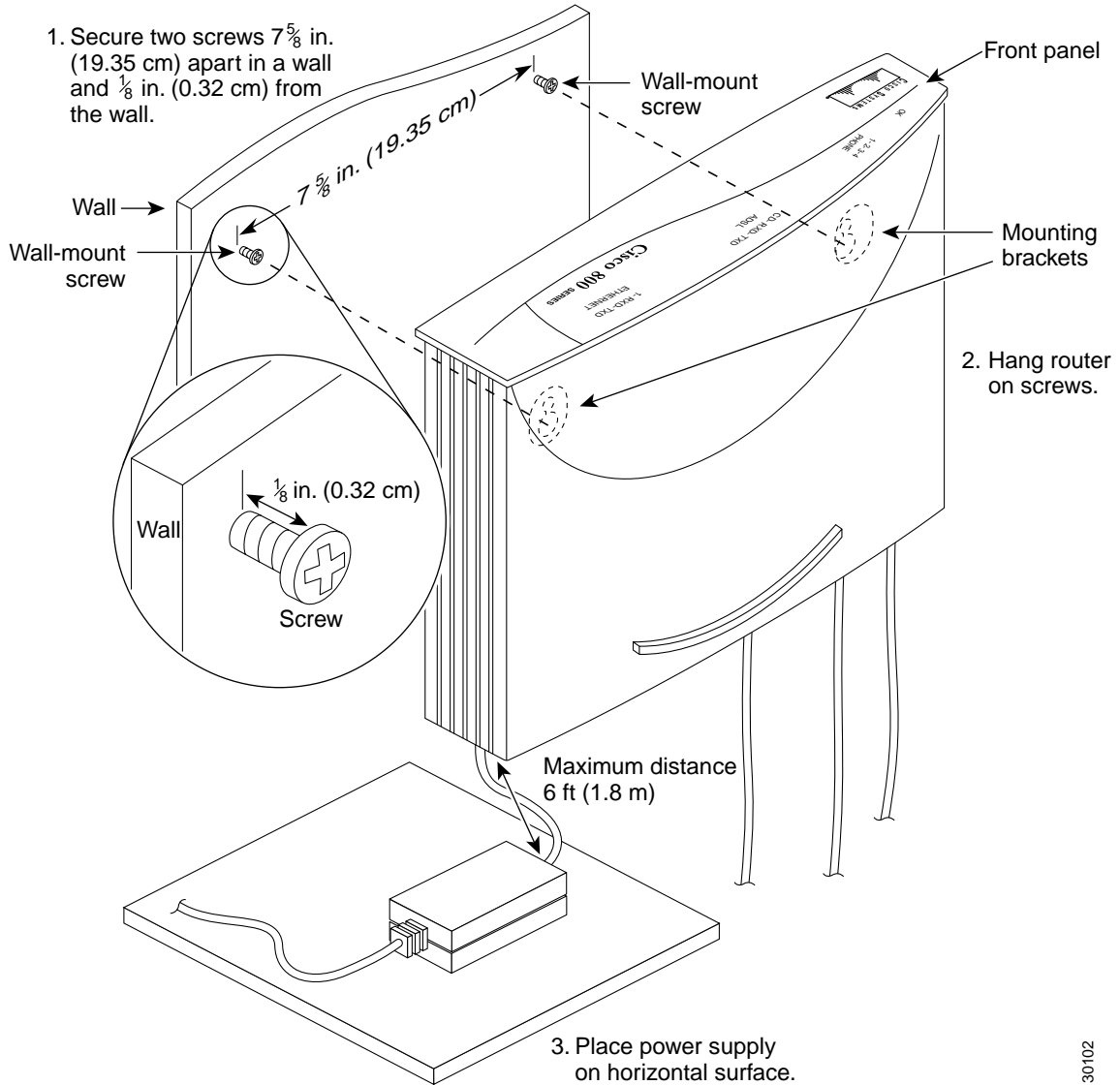
If you are mounting the router on drywall, use two hollow wall-anchors (1/8-in. with 5/16-in. drill bit, or M3 with 8-mm drill bit) to secure the screws. If the screws are not properly anchored, the strain of the network cable connections could pull the router from the wall.

The following requirements must be met when you mount the router:

- Because the LEDs are used as status and problem indicators, the LEDs on the front panel must face upward and be easily visible.
- The back panel must face downward to reduce strain on the cable connections.
- The power supply must rest on a horizontal surface, such as the floor or a table. If the power supply is not supported, strain on the power supply cable could cause it to disconnect from the connector on the router back panel.

To mount the router, follow the steps in Figure 2-3. The last page of this manual provides a template for measuring the distance between the screws.

Figure 2-3 Mounting Router on a Wall



30102

Installing the Router

To install the router, you need to perform the following tasks in the following order:

1. Connect the Ethernet devices to the router.
2. Connect the ADSL line.
3. Connect an optional analog telephone or fax machine.

4. Connect a terminal or PC to the router for software configuration using the command-line interface (CLI) or for troubleshooting.
5. Connect the router to the power source.
6. Verify the links using the router LEDs.

Connect Ethernet Devices

Table 2-1 lists the Ethernet devices you can connect to Cisco 827, Cisco 827-4V, and SOHO 77 routers; the connections for each device; and the settings of the router TO HUB/TO PC button (the default setting is IN).

Table 2-1 Ethernet Device Connections for Cisco 827, Cisco 827-4V, and SOHO 77 Routers

Network Device Connected To Router	Router Port	Ethernet Cable Type ¹	Router HUB/NO HUB Button Setting	Network Device Button Setting ²
Hub with equivalent to router TO HUB/TO PC button	ETHERNET port 1	Straight-through	IN	MDI (IN)
Hub with equivalent to router TO HUB/TO PC button	ETHERNET port 1	Straight-through	OUT	MDI-X (OUT)
Hub without equivalent to router TO HUB/TO PC button	ETHERNET port 1	Straight-through	OUT	MDI-X (OUT)
Server, PC, or workstation	ETHERNET port 1	Straight-through	OUT	–

1. Cisco provides a yellow straight-through cable. You provide crossover or additional straight-through cables. For details on cables, see Appendix A, “Specifications and Cables.”
2. Hub vendors choose different names for the button that controls the cable selection. This table uses the Cisco 1528 Micro Hub 10/100 with an MDI/MDI-X button as an example. Determine the button name and setting for your particular hub. Refer to your hub documentation for details.

Table 2-2 lists the Ethernet devices you can connect to Cisco 827H and SOHO 77H routers, the connections for each device, and the settings of the router TO HUB/TO PC button (the default setting is IN).

Table 2-2 Ethernet Device Connections for Cisco 827H and SOHO 77H Routers

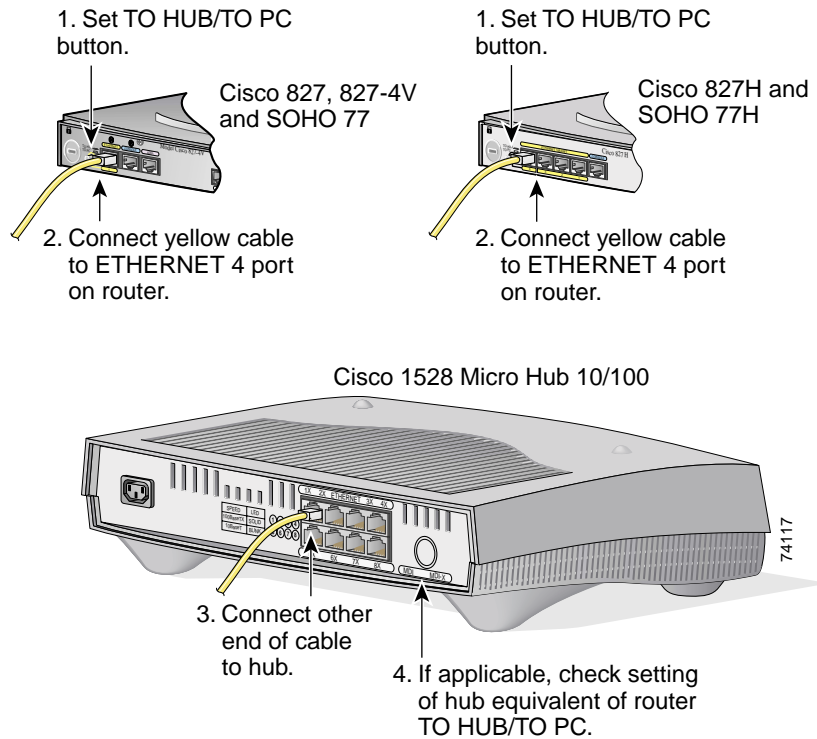
Network Device Connected to Router	Router Port	Ethernet Cable Type ¹	Router TO HUB/TO PC Button Setting	Network Device Button Setting ²
Hub with equivalent to router TO HUB/TO PC button	ETHERNET port 4	Straight-through	IN	MDI (IN)
Hub with equivalent to router TO HUB/TO PC button	ETHERNET port 4	Straight-through	OUT	MDI-X (OUT)
Hub without equivalent to router TO HUB/TO PC button	ETHERNET port 4	Straight-through	OUT	MDI-X (OUT)
Server, PC, or workstation	ETHERNET port 4	Straight-through	OUT	–
Hub with equivalent to router TO HUB/TO PC button	ETHERNET port 1, 2, 3	Crossover	N/A	MDI (IN)
Hub with equivalent to router TO HUB/TO PC button	ETHERNET port 1, 2, 3	Straight-through	N/A	MDI-X (OUT)
Hub without equivalent to router TO HUB/TO PC button	ETHERNET port 1, 2, 3	Crossover	N/A	MDI-X (OUT)
Server, PC, or workstation	ETHERNET port 1, 2, 3	Straight-through	N/A	–

1. Cisco provides a yellow straight-through cable. You provide crossover or additional straight-through cables. For cable specifications, see Appendix A, “Specifications and Cables.”
2. Hub vendors choose different names for the button that controls the cable selection. This table uses the Cisco 1528 Micro Hub 10/100 with an MDI/MDI-X button as an example. Determine the button name and setting for your particular hub. See your hub documentation for details.

Connecting Hubs

Before connecting a hub to the router, see Table 2-1 to determine how to set the router TO HUB/TO PC button. To connect a hub to the router, follow the steps in Figure 2-4.

Figure 2-4 Connecting a Hub to the Router



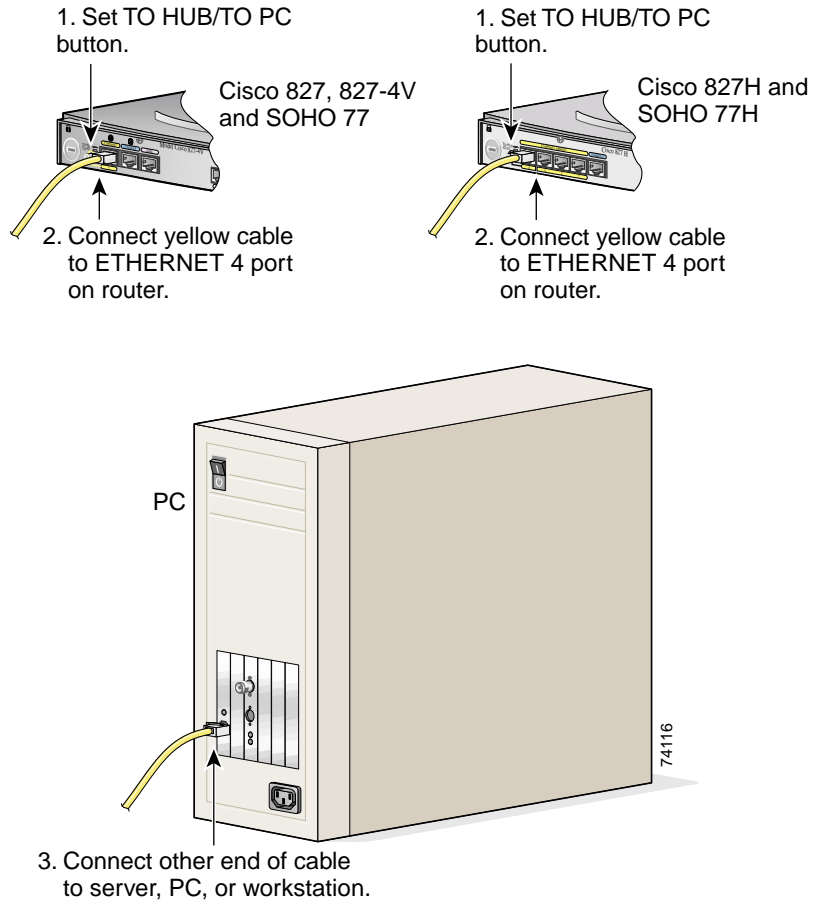
To verify the hub connection, check that the port's Ethernet LED on the front panel is on after you complete the router installation.

Connecting a Server, PC, or Workstation

Before connecting a server, PC, or workstation to the router, see Table 2-1 on page 2-10 to determine how to set the router TO HUB/TO PC button.

To connect a server, PC, or workstation to the router, follow the steps in Figure 2-5 on page 2-14.

Figure 2-5 Connecting a Server, PC, or Workstation to the Router



To verify the connection, check that the Ethernet 1 LED is on after you complete the router installation.

Connect an ADSL Line

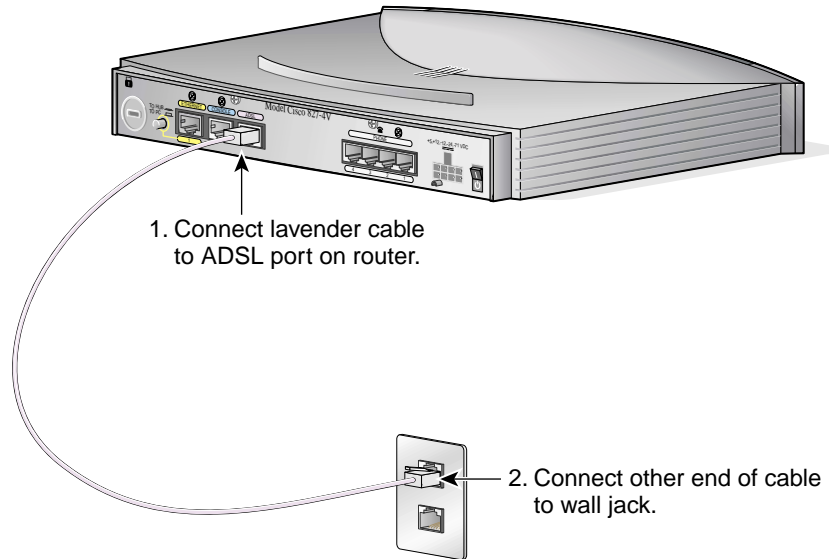
The procedure for connecting an ADSL line depends on the router and, in some cases, on the location. Figure 2-6 shows how to connect the ADSL line to a cable wall jack. (Figure 2-6 depicts a Cisco 827-4V router, but the process is the same for Cisco 827, Cisco 827H, SOHO 77, and SOHO 77H routers.)



Warning

Do not work on the system or connect or disconnect cables during periods of lightning activity.

Figure 2-6 Connecting an ADSL Line to a Wall Jack



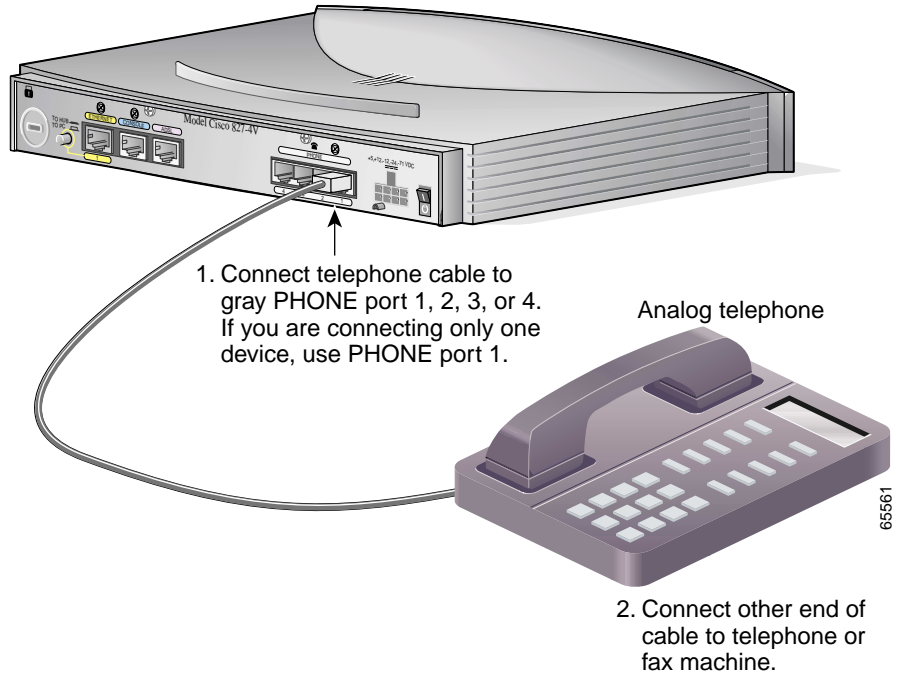
65560

Connect an Analog Telephone or Fax Machine (Cisco 827-4V Routers Only)

You can connect as many as four devices such as analog push button telephones or fax machines to a Cisco 827-4V router. Each device is connected to basic telephone services through the color-coded gray phone ports.

To connect an analog telephone or fax machine, follow the steps in Figure 2-7. You must provide the telephone cable for connecting each device. The telephone cable is usually provided with the device.

Figure 2-7 Connecting an Analog Telephone or Fax Machine

**Warning**

This equipment contains a ring signal generator (ringer), which is a source of hazardous voltage. Do not touch the RJ-11 (phone) port wires (conductors), the conductors of a cable connected to the RJ-11 port, or the associated circuit-board when the ringer is active. The ringer is activated (indicated by a clicking sound) by an incoming call.

**Caution**

Do not connect the router telephone ports to the telephone wall jack. These ports are not meant for direct connection to a public network. This connection can damage your router.

The gray phone ports are RJ-11 connectors. If you are outside North America, you must buy and attach adapters that allow telephones or fax machines to be connected to these RJ-11 connectors. In some countries, these adapters need additional electronics so that the telephones or fax machines will work properly with the router phone ports. For example, in the United Kingdom, you must buy an adapter that also provides a *master socket*, which causes incoming calls to ring the connected devices. For information on recommended master sockets, see Table 2-3.

Table 2-3 Recommended Vendors for Master Sockets Required for United Kingdom

Vendor Name	Product Name	For More Information
RS Components	Avro Pacific Telephone Ring Adapter (part number 303-2000)	http://www.rswwww.com/
Tandy	Export Adapter (part number 2797057)	http://www.tandy.co.uk/

Connect a Terminal or PC to the Router's Console Port (Optional)

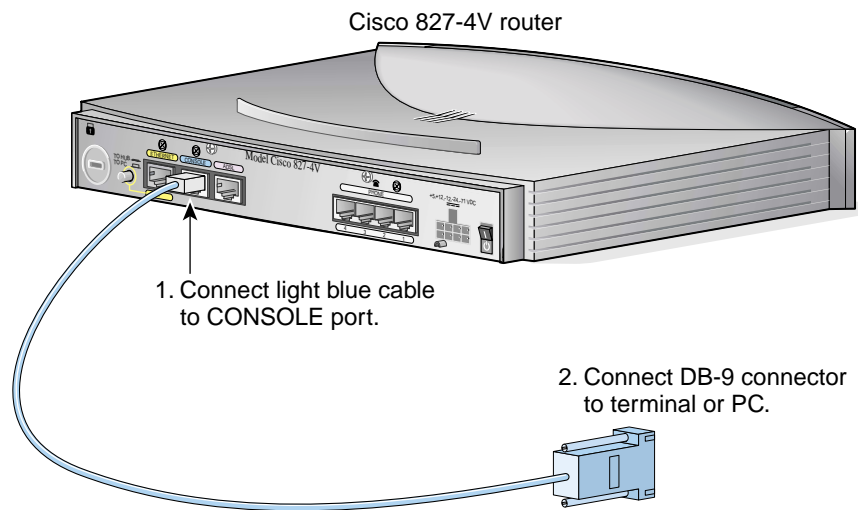
You can connect either a terminal or a PC to the router's console port. You can use the terminal or PC for configuring the software via the command line interface (CLI) or for troubleshooting. To connect a terminal or PC, follow the steps in Figure 2-8. (Figure 2-8 depicts a Cisco 827-4V, but the process applies to connecting all Cisco 827 series routers and SOHO 77 series routers.)



Note

Unless you are an experienced network administrator, it is recommended that you use the Cisco Router Web Setup software to configure the router. Use of this software is described in the "Using Cisco Router Web Setup to Configure the Router" section on page 2-22.

Figure 2-8 Connecting a Terminal or PC



If you have experience configuring Cisco routers and prefer to use the CLI, refer to the *Cisco 827 Router Software Configuration Guide* for instructions on configuring the router.

Connect the AC Adapter

To connect the power supply, follow the steps in Figure 2-9. (Figure 2-9 depicts a Cisco 827-4V router, but the process is the same for the Cisco 827, Cisco 827H, SOHO 77, and SOHO 77H routers.)



Warning

The device is designed to work with TN power systems.



Warning

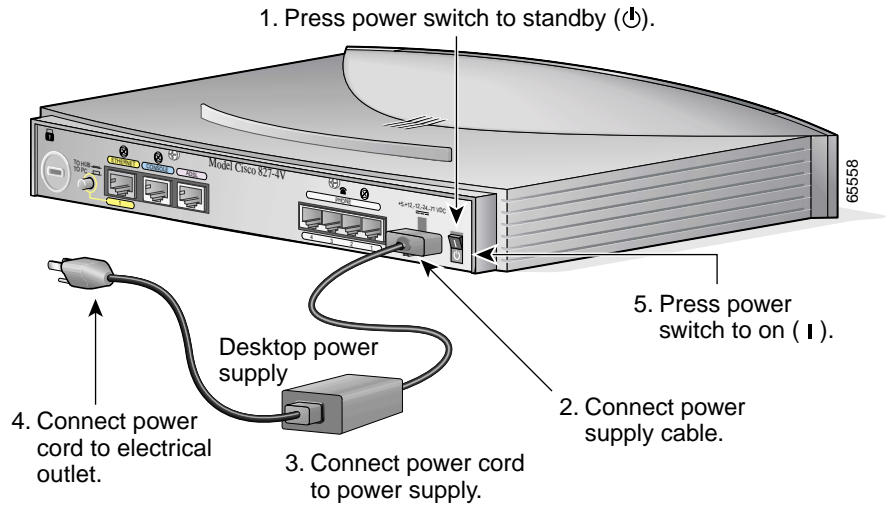
This product relies on the building's installation for short-circuit (overcurrent) protection. Ensure that a fuse or circuit breaker no larger than 120 VAC, 15A U.S. (240 VAC, 16A international) is used on the phase conductors (all current-carrying conductors).



Warning

This equipment is intended to be grounded. Ensure that the host is connected to earth ground during normal use.

Figure 2-9 Connecting the AC Adapter

**Note**

Be sure to use the power supply that was shipped with your router. Although you may be able to connect another Cisco power supply to your router, that power supply may not provide all the features that the power supply that shipped with your router does.

Using the Router LEDs to Check Links

Use the LEDs on the front of the router to check the links between the router and attached Ethernet devices or telephones. Use Table 2-4 to verify the link status of devices attached to Cisco 827, Cisco 827-4V, and SOHO 77 routers.

Table 2-4 LED Patterns for Cisco 827, Cisco 827-4V and SOHO 77 Routers

Power/Link	LEDs to Check	Normal Patterns
Power	OK	On
To hub, server, PC, or workstation	ETHERNET 1, ETHERNET RXD, and ETHERNET TXD	<ul style="list-style-type: none"> ETHERNET 1 is on when the Ethernet is physically connected. ETHERNET RXD blinks when an Ethernet port receives an Ethernet packet. ETHERNET TXD blinks when an Ethernet port sends an Ethernet packet.
To analog telephone or fax machine (827-4V only)	PHONE 1, PHONE 2, PHONE 3, PHONE 4 ¹	On when telephone or fax machine is in use.

1. You can also pick up the handset and listen for a dial tone.

Use Table 2-5 to verify the link status of devices attached to Cisco 827H and SOHO 77H routers.

Table 2-5 LED Patterns for Cisco 827H and SOHO 77H Routers

Power/Link	LEDs to Check	Normal Patterns
Power	OK	On
To hub, server, PC, or workstation	ETHERNET 1, 2, 3, or 4; ETHERNET RXD; and ETHERNET TXD	<ul style="list-style-type: none"> ETHERNET LED is on when the Ethernet is physically connected to the appropriate port. RXD LED blinks when an Ethernet port receives an Ethernet packet. TXD LED blinks when an Ethernet port sends an Ethernet packet.

Configuring the Router

When you have finished installing the router, you must configure the router software. First, check PC configurations to ensure that all PCs will be able to communicate with the router. Then configure the router software using the web interface.

Checking the PC Configuration


Each PC that is connected to the router must be configured to use the Transmission Control Protocol/Internet Protocol (TCP/IP) and to obtain its IP address automatically. Follow these steps to configure each PC that is running Microsoft Windows NT or Microsoft Windows 95 or 98. If the PC is running a different version of Microsoft Windows, refer to the documentation that came with the PC.

-
- Step 1** Start the PC, and open the Control Panel.
 - Step 2** Click the **Network** icon to display the Network window.
 - Step 3** Verify that TCP/IP has been added and associated with the Ethernet adapter. TCP/IP is shown as a cable icon in the Configuration window on Microsoft Windows 95 and 98; it is shown as a cable icon in the Protocol window on Microsoft Windows NT. If the icon is not visible, click **Add**, and add the Microsoft TCP/IP protocol.
 - Step 4** To verify that the PC is configured to obtain an IP address automatically, click the TCP/IP cable icon, and select the **IP address** tab in the TCP/IP Properties window. Check **Obtain an IP address from a DHCP server** if it is not checked. The IP address and Subnet mask fields should be greyed out.
 - Step 5** Click **OK** to accept all changes and exit this window, and click **OK** in the Network window.
 - Step 6** To reboot the PC, click **Yes** if you are prompted.
-

For more information on how to configure TCP/IP, refer to the *Cisco Router Web Setup Troubleshooting Guide*, which is available on the Cisco 800 and SOHO Series Product Documentation CD.

Using Cisco Router Web Setup to Configure the Router

Cisco strongly recommends that inexperienced network administrators use the Cisco Router Web Setup application that has been installed on the router. To use this application, complete the following steps:

-
- Step 1** Start, or restart, one of the PCs connected to the router through ETHERNET port 1, 2, 3, or 4.
- Step 2** Open a web browser. Make sure that your browser is set to work in online mode.
- In Internet Explorer, click the File menu, and verify that the work offline option is unchecked.
 - In Netscape, the default selection in the File menu is set to work online.
- Step 3** Type in the universal resource locator (URL) **http://10.10.10.1**. The CRWS home page will appear in one or two minutes.
-  **Tip** If the CRWS home page does not appear when you enter the URL **http://10.10.10.1**, test the connection between the PC and the router by doing the following:
1. Check that the OK LED on the router is on, and check the cable connection between the router and the PC. Be sure that the TO HUB/TO PC button is in the correct position. The button is in the correct position if the LED for the port on the front of the router is on.
 2. If the CRWS home page still does not appear, verify that the web browser's "work offline" option is disabled.
 3. If the web page still does not appear, verify that your PC is automatically configured to receive an IP address. Follow the instructions in the *Cisco Router Web Setup Troubleshooting Guide*, which is available on the Cisco 800 and SOHO Series Product Documentation CD.
 4. If the PC is configured to automatically receive an IP address, but the web page still does not appear, select **Start/Run**, type **winipcfg** in the Run window, and examine the address in the IP address field. The address should be in the format 10.10.10.X, in which X is a number that is equal or greater than 2; for example, 10.10.10.2, or 10.10.10.3. If the IP address is not in this format, verify that an Ethernet adapter name is visible in the Adapter field. If there is no name in the field, return to Step 3 in "Checking the PC Configuration," add TCP to the list of protocols. Then return to "Using Cisco Router Web Setup to Configure the Router, page 2-22," and complete the procedure.
-
- Step 4** If you have no special configuration requirements, click the **Router Setup** link on the home page, and then click **Easy Setup**. (This may appear as **Quick Setup** on some models.) Then, enter the user name and password provided to you by your Internet service provider, and click **Apply**.
- Step 5** If you need to configure special features such as Network Address Translation (NAT), click the appropriate links on the home page, and complete the configuration screens.
- Step 6** Click the **Password** link on the home page, and set a password for the router.
- Step 7** Click the **Test Connection** link on the home page, and allow the connection to be tested.
- Step 8** Select **Start/Run**, and type **winipcfg** in the Open field of the Run window. When the IP Config window appears, click **Release** to release the PC's IP address. Then click **Renew** to renew the PC's IP address. Alternatively, open the Run window and enter **ipconfig /release** to release the PC's IP address. Then enter **ipconfig /renew** to renew the IP address of the PC.
- Step 9** Open a web browser on the PC, and connect to a website.
-

The router installation is complete when you have connected to a website.



Troubleshooting

This chapter describes symptoms of problems that could occur with the Cisco 827 or SOHO 77 routers, identifies the likely underlying problems, and provides steps for solving the problems. The problems are grouped into the following areas:

- Problems during first startup
- Problems after the router has been up and running

For more information about problems that could occur with the software, refer to the *Cisco 827 Routers Software Configuration Guide*.

Before You Call Your Cisco Reseller

Some of the solutions in this chapter instruct you to contact your Cisco reseller. Before you contact your reseller, make sure you have the following information available:

- Router model and serial number (on the back panel)
- Maintenance agreement or warranty information
- Date you received the router
- Brief description of the problem
- Brief description of the steps you have taken to solve the problem

Problems During First Startup

Table 3-1 lists problems that could occur the first time you turn on the power switch.

Table 3-1 Problems During First Startup

Symptom	Problem	Solutions
All LEDs, including OK LED, are off.	No power to router.	Perform the following steps: <ol style="list-style-type: none"> 1. Make sure that the power switch is set to ON. 2. Make sure that all connections to and from the power supply are secure. 3. Make sure that the power outlet has power. 4. If the problem continues, the power supply might be faulty. Contact your Cisco reseller.
No connection to Ethernet device. (Ethernet 1 LED is off.)	<ul style="list-style-type: none"> • A cable-related problem: <ul style="list-style-type: none"> – Improperly connected cable. – Damaged cable. 	Perform the following steps: <ol style="list-style-type: none"> 1. To make sure that you have cabled the device correctly, see Figure 2-4 or Figure 2-5 in Chapter 2, “Installation.” 2. Make sure that the connectors at both ends of the cable are securely seated. 3. Make sure that the cable is not physically damaged. If it is damaged, order another cable from Cisco or replace it with a similar cable.
	<ul style="list-style-type: none"> • Improperly set router TO HUB/TO PC button or hub equivalent of TO HUB/TO PC button. 	<ul style="list-style-type: none"> • To make sure that you have set buttons correctly, see Table 2-1 on page 2-10 if you are installing a Cisco 827, Cisco 827-4V, or SOHO 77 router. See Table 2-2 on page 2-11 if you are installing a Cisco 827H or SOHO 77H router.
No connection to ADSL link. (The CD LED on the front panel is off for a long time.)	<ul style="list-style-type: none"> • Wrong cable. 	<ul style="list-style-type: none"> • To make sure that you are using the correct cable, refer to Appendix A, “Specifications and Cables.”
	<ul style="list-style-type: none"> • Improperly connected cable. 	<ul style="list-style-type: none"> • To make sure that you have connected the ADSL cable properly, see Figure 2-6 in Chapter 2, “Installation.” • Make sure that the connectors at both ends of the cable are securely seated.

Problems After Router Is Running

Table 3-2 lists problems that could occur after the router has been up and running.

Table 3-2 *Problems After Router Is Running*

Symptom	Problem	Solutions
Problems with Ethernet connection. (ETHERNET 1, 2, 3, or 4 LED is off.)	<ul style="list-style-type: none"> • A cable-related problem: <ul style="list-style-type: none"> – Disconnected cable. – Damaged cable. 	Perform the following steps: <ol style="list-style-type: none"> 1. Make sure that the connectors at both ends of the cable are secure. 2. Make sure that the cable is not physically damaged. If it is damaged, order another cable from Cisco Systems or replace it with a similar cable.
Connection to the ADSL line is intermittent or lost. (The CD LED on the front panel is off.)	<ul style="list-style-type: none"> • A cable-related problem: <ul style="list-style-type: none"> – Disconnected cable. – Damaged cable. 	<ul style="list-style-type: none"> • Make sure that the connectors at both ends of the cable are secure. • Make sure that the cable is not physically damaged. If it is damaged, order another cable from Cisco Systems or replace it with a similar cable.
	<ul style="list-style-type: none"> • Problem with ADSL line or WAN service. 	<ul style="list-style-type: none"> • Contact your ADSL line or WAN service provider to determine whether there is a problem with the ADSL or WAN service.



Specifications and Cables

This appendix provides system, port, and cabling specifications for the Cisco 827 routers.

System Specifications

Table A-1 outlines the system specifications for the routers.

Table A-1 System Specifications

Description	Design Specification
Physical Dimensions	
Dimensions (H x W x D)	2.0 x 9.7 x 8.5 in. (5.1 x 24.6 x 21.6 cm)
Weight (does not include desktop power supply)	<ul style="list-style-type: none"> • Cisco 827-4V router: 1.5 lb. (0.68 kg) • Cisco 827H router: 1.48 lb. (0.67 kg) • Cisco 827 router: 1.48 lb. (0.67 kg)
Environmental Operating Ranges	
Nonoperating temperature	–4 to 149°F (–20 to 65°C)
Nonoperating humidity	5 to 95%, relative humidity
Nonoperating altitude	0 to 15,000 ft (4570 m)
Operating temperature	32 to 104°F (0 to 40°C)
Operating humidity	10 to 85% relative humidity
Operating altitude	0 to 10,000 ft (3000 m)
Router Power (Cisco 827, 827-4V, and SOHO 77)	
AC input voltage	100 to 250 VAC
Frequency	50 to 60 Hz
Power consumption	29W
Router Power (Cisco 827H and SOHO 77H)	
AC input voltage	100 to 240 VAC
Frequency	50 to 60 Hz
Power consumption	15W

Table A-1 System Specifications (continued)

Description	Design Specification
Telephone Port Power (Cisco 827-4V)	
Voltage	-24V and -71V

For information on regulatory compliance, refer to the *Regulatory Compliance and Safety Information for Cisco 827 Routers* document that shipped with your router.



Warning

Ultimate disposal of this product should be handled according to all national laws and regulations.

Port Connector Pinouts

This section provides pinouts for the following connectors:

- Ethernet—See Table A-2.
- Console (for connecting a terminal or PC)—See Table A-3.
- Telephone—See Table A-4.
- ADSL—See Table A-5
- Power—See Table A-6 and Table A-7.

Table A-2 shows the Ethernet connector pinouts for the Cisco 827-4V, Cisco 827, Cisco 827H, SOHO 77, and SOHO 77H routers.

Table A-2 Ethernet Connector Pinouts (RJ-45)

Pin	Function (TO HUB/TO PC Button – IN Position)	Function (TO HUB/TO PC Button – OUT Position)
1	TX+	RX+
2	TX–	RX–
3	RX+	TX+
4	Unused	Unused
5	Unused	Unused
6	RX–	TX–
7	Unused	Unused
8	Unused	Unused

Table A-3 shows the Ethernet connector pinouts for the Cisco 827-4V, Cisco 827, Cisco 827H, SOHO 77, and SOHO 77H routers.

Table A-3 Console Connector Pinouts (RJ-45)

Pin	Function
1	RTS
2	DTR
3	TXD
4	GND
5	GND
6	RXD
7	DSR
8	CTS

The console port is configured as a data communications equipment (DCE) device. The default parameters for the console port are as follows:

- 9600 baud
- Eight data bits
- No parity
- One stop bit

Table A-4 shows telephone connector pinouts for the Cisco 827-4V router.

Table A-4 Cisco 827-4V Router Telephone Connector Pinouts (RJ-11)

Pin	Function
1	Unused
2	Tip
3	Ring
4	Unused

Table A-5 shows ADSL connector pinouts for the Cisco 827-4V, Cisco 827, Cisco 827H, SOHO 77, and SOHO 77H routers.

Table A-5 ADSL Connector Pinouts (RJ-11)

Pin	Function
1	Loopback to pin 6
2	Unused
3	Tip
4	Ring
5	Unused
6	Loopback to pin 1

Table A-6 shows the power connector pinouts for the Cisco 827, Cisco 827-4V, and SOHO 77 routers.

Table A-6 Cisco 827, Cisco 827-4V, and SOHO 77 Power Connector Pinouts

Pin	Function
1	ROF
2	RTN
3	+12
4	-12
5	+5
6	RTN
7	-71
8	-24

Table A-7 shows the power connector pinouts for the Cisco 827H and SOHO 77H routers.

Table A-7 Cisco 827H and SOHO 77H Power Connector Pinouts

Pin	Function
1	ROF
2	RTN
3	AC_Lost
4	Unused
5	+5VF
6	RTN
7	Unused
8	Unused

Cabling Specifications

This section provides specifications for the following Ethernet cables, which you might need to provide:

- Straight-through cables
- Crossover cables

This section also provides information on Ethernet and telephone cable distance limitations. (Telephone cable connects a device to a telephone port.)

Ethernet Cable Specifications

Table A-8 lists the specifications for straight-through and crossover Ethernet cables.

Table A-8 Ethernet Cable Specifications

Type	Category	Shielding
10BASE-T	Category 3 or 5	Shielded twisted-pair (STP)
10BASE-T	–	Unshielded twisted-pair (UTP)

Maximum Cable Distances

Table A-9 provides the maximum distances of Ethernet and telephone cables that you can use to connect equipment to the router.

Table A-9 Maximum Cable Distances

Cable	Maximum Distance
Ethernet cables	328 ft (100 m)
Telephone cable	500 ft (152 m)



Numerics

10BASE-T Ethernet ports 1-2

A

AC input voltage (table) A-2

adapter included with router (figure) 2-5

ADSL 1-2

ADSL line, connecting (figure) 2-15

ADSL port (figure) 1-3, 1-5

altitude specifications (table) A-1

analog telephone, connecting 2-16

Asymmetric digital subscriber line

See ADSL

B

back panels (figures) 1-5

brackets (figure) 2-7

C

cable lock (figure) 1-6, 1-7, 1-8

cables

and router damage 2-6

Ethernet, types 2-10, 2-11

included with router (figure) 2-5

cabling

distances, maximum (table) A-6

specifications (table) A-6

caution statements defined x

Cisco Router Web Setup 2-22

console port 1-2

console port (figure) 1-6, 1-7, 1-8

conventions, note, caution, and warning x

D

documentation, included with router 2-5

DRAM 1-2

dynamic RAM

See DRAM

E

electrostatic damage, preventing 2-3

ETHERNET 1 LED 2-20

Ethernet cable

specifications A-6

types 2-10, 2-11

Ethernet devices, connecting 2-10

Ethernet LEDs 2-20

Ethernet port (figure) 1-3, 1-5

ETHERNET RXD LED 2-20
 ETHERNET TXD LED 2-20
 European Union standards 2-6

F

fax machine, connecting 2-16
 feature summary 1-2
 Flash memory 1-2
 frequency specifications A-2
 front panels (figure) 1-3 to 1-4

H

HUB/NO HUB button settings 2-10
 hubs, connecting 2-12
 humidity specifications A-1

I

installation
 preparing for 2-1
 verifying 2-20

L

LED functions
 Cisco 827-4V router 1-8
 Cisco 827H router 1-9
 Cisco 827 router 1-9
 SOHO 77H 1-9
 SOHO 77 router 1-9
 verifying installation 2-20
 See also troubleshooting
 locking power connector (figure) 1-6, 1-7, 1-8

M

master sockets, vendors 2-17

mounting router 2-7

N

note statements defined x

P

PC, connecting 2-13, 2-17
 PHONE LEDs 2-20
 pinouts A-2
 ports, for specific routers 1-3
 power
 problems 3-2
 specifications A-2
 power connector, locking 1-3
 power supply
 connecting 2-18
 included with router 2-5
 power switch (figure) 1-6, 1-7
 preinstallation activities 2-5
 problems
 after router is running 3-4
 during first startup 3-2
 procedure for installing the router 2-10 to 2-19

R

related documentation xii
 router damage, preventing 2-6

S

safety warnings 2-2
 server, connecting 2-13
 specifications
 cabling A-6
 system A-1
 startup problems 3-2

T

- table mounting 2-7
- telephone ports 1-2
- telephones, connecting 2-16
- temperature specifications A-1
- terminal, connecting 2-17
- TO HUB/TO PC buttons (figure) 1-3, 1-5
- TO HUB/TO PC button settings 2-11
- troubleshooting
 - after router is running 3-4
 - during first startup 3-2

U

- unpacking the router 2-4

V

- voltage specifications A-2

W

- wall brackets (figure) 2-7
- wall mounting 2-7, 2-9
- warnings, installation 2-2
- warning statements defined x
- weight specifications A-1
- workstation, connecting 2-13

