



X11SSL-CF  
X11SSL-nF

USER MANUAL

Revision 1.0b

The information in this User Manual has been carefully reviewed and is believed to be accurate. The vendor assumes no responsibility for any inaccuracies that may be contained in this document, and makes no commitment to update or to keep current the information in this manual, or to notify any person or organization of the updates. **Please Note: For the most up-to-date version of this manual, please see our website at [www.supermicro.com](http://www.supermicro.com).**

Super Micro Computer, Inc. ("Supermicro") reserves the right to make changes to the product described in this manual at any time and without notice. This product, including software and documentation, is the property of Supermicro and/or its licensors, and is supplied only under a license. Any use or reproduction of this product is not allowed, except as expressly permitted by the terms of said license.

IN NO EVENT WILL Super Micro Computer, Inc. BE LIABLE FOR DIRECT, INDIRECT, SPECIAL, INCIDENTAL, SPECULATIVE OR CONSEQUENTIAL DAMAGES ARISING FROM THE USE OR INABILITY TO USE THIS PRODUCT OR DOCUMENTATION, EVEN IF ADVISED OF THE POSSIBILITY OF SUCH DAMAGES. IN PARTICULAR, SUPER MICRO COMPUTER, INC. SHALL NOT HAVE LIABILITY FOR ANY HARDWARE, SOFTWARE, OR DATA STORED OR USED WITH THE PRODUCT, INCLUDING THE COSTS OF REPAIRING, REPLACING, INTEGRATING, INSTALLING OR RECOVERING SUCH HARDWARE, SOFTWARE, OR DATA.

Any disputes arising between manufacturer and customer shall be governed by the laws of Santa Clara County in the State of California, USA. The State of California, County of Santa Clara shall be the exclusive venue for the resolution of any such disputes. Supermicro's total liability for all claims will not exceed the price paid for the hardware product.

FCC Statement: This equipment has been tested and found to comply with the limits for a Class A digital device pursuant to Part 15 of the FCC Rules. These limits are designed to provide reasonable protection against harmful interference when the equipment is operated in a commercial environment. This equipment generates, uses, and can radiate radio frequency energy and, if not installed and used in accordance with the manufacturer's instruction manual, may cause harmful interference with radio communications. Operation of this equipment in a residential area is likely to cause harmful interference, in which case you will be required to correct the interference at your own expense.

California Best Management Practices Regulations for Perchlorate Materials: This Perchlorate warning applies only to products containing CR (Manganese Dioxide) Lithium coin cells. "Perchlorate Material-special handling may apply. See [www.dtsc.ca.gov/hazardouswaste/perchlorate](http://www.dtsc.ca.gov/hazardouswaste/perchlorate)".

**WARNING:** Handling of lead solder materials used in this product may expose you to lead, a chemical known to the State of California to cause birth defects and other reproductive harm.

The products sold by Supermicro are not intended for and will not be used in life support systems, medical equipment, nuclear facilities or systems, aircraft, aircraft devices, aircraft/emergency communication devices or other critical systems whose failure to perform be reasonably expected to result in significant injury or loss of life or catastrophic property damage. Accordingly, Supermicro disclaims any and all liability, and should buyer use or sell such products for use in such ultra-hazardous applications, it does so entirely at its own risk. Furthermore, buyer agrees to fully indemnify, defend and hold Supermicro harmless for and against any and all claims, demands, actions, litigation, and proceedings of any kind arising out of or related to such ultra-hazardous use or sale.

Manual Revision: 1.0b

Release Date: May 25, 2016

Unless you request and receive written permission from Super Micro Computer, Inc., you may not copy any part of this document. Information in this document is subject to change without notice. Other products and companies referred to herein are trademarks or registered trademarks of their respective companies or mark holders.

Copyright © 2016 by Super Micro Computer, Inc.  
All rights reserved.

**Printed in the United States of America**

# Preface

## About This Manual

This manual is written for system integrators, IT technicians and knowledgeable end users. It provides information for the installation and use of the X11SSL-CF/-nF motherboard.

## About This Motherboard

The Super X11SSL-CF/-nF motherboard supports an Intel Xeon E3-1200 v5, 6th-Gen Core i3, Pentium, or Celeron processor in an LGA 1151 (H4) socket. With support of the Intel C232 chipset, DDR4 2133 memory, SATA 3.0, SAS 3.0 (12 Gb/ps)\*, NVMe SSDs\*\*, and Trusted Platform Module (TPM), this motherboard offers a cost-optimized storage solution in the Micro-ATX form factor. Please also note that this motherboard is intended to be installed and serviced by professional technicians only. For processor/memory updates, please refer to our website at <http://www.supermicro.com/products/>.

\*SAS 3.0 is available on the -CF model only.

\*\*NVMe is supported by the -nF model only.

## Conventions Used in the Manual

Special attention should be given to the following symbols for proper installation and to prevent damage done to the components or injury to yourself:



**Warning!** Indicates important information given to prevent equipment/property damage or personal injury.



**Warning!** Indicates high voltage may be encountered when performing a procedure.



**Important:** Important information given to ensure proper system installation or to relay safety precautions.



**Note:** Additional Information given to differentiate various models or provides information for correct system setup.

## Contacting Supermicro

### Headquarters

Address: Super Micro Computer, Inc.  
980 Rock Ave.  
San Jose, CA 95131 U.S.A.

Tel: +1 (408) 503-8000

Fax: +1 (408) 503-8008

Email: [marketing@supermicro.com](mailto:marketing@supermicro.com) (General Information)  
[support@supermicro.com](mailto:support@supermicro.com) (Technical Support)

Website: [www.supermicro.com](http://www.supermicro.com)

### Europe

Address: Super Micro Computer B.V.  
Het Sterrenbeeld 28, 5215 ML  
's-Hertogenbosch, The Netherlands

Tel: +31 (0) 73-6400390

Fax: +31 (0) 73-6416525

Email: [sales@supermicro.nl](mailto:sales@supermicro.nl) (General Information)  
[support@supermicro.nl](mailto:support@supermicro.nl) (Technical Support)  
[rma@supermicro.nl](mailto:rma@supermicro.nl) (Customer Support)

Website: [www.supermicro.nl](http://www.supermicro.nl)

### Asia-Pacific

Address: Super Micro Computer, Inc.  
3F, No. 150, Jian 1st Rd.  
Zhonghe Dist., New Taipei City 235  
Taiwan (R.O.C)

Tel: +886-(2) 8226-3990

Fax: +886-(2) 8226-3992

Email: [support@supermicro.com.tw](mailto:support@supermicro.com.tw)

Website: [www.supermicro.com.tw](http://www.supermicro.com.tw)

# Table of Contents

## **Chapter 1 Introduction**

1.1 Checklist .....	7
Quick Reference .....	11
Quick Reference Table .....	12
Motherboard Features .....	14
1.2 Processor and Chipset Overview .....	18
1.3 Special Features .....	18
Recovery from AC Power Loss .....	18
1.4 System Health Monitoring .....	19
Onboard Voltage Monitors .....	19
Fan Status Monitor with Firmware Control .....	19
Environmental Temperature Control .....	19
System Resource Alert .....	19
1.5 ACPI Features .....	19
1.6 Power Supply .....	20
1.7 Serial Port .....	20

## **Chapter 2 Installation**

2.1 Static-Sensitive Devices .....	21
Precautions .....	21
Unpacking .....	21
2.2 Motherboard Installation .....	22
Tools Needed .....	22
Location of Mounting Holes .....	22
Installing the Motherboard .....	23
2.3 Processor and Heatsink Installation .....	24
Installing the LGA1151 Processor .....	24
Installing an Active CPU Heatsink with Fan .....	27
Removing the Heatsink .....	29
2.4 Memory Support and Installation .....	30
Memory Support .....	30
DIMM Module Population Configuration .....	30
DIMM Module Population Sequence .....	31

---

---

DIMM Installation .....	32
DIMM Removal .....	32
2.5 Rear I/O Ports .....	33
2.6 Front Control Panel .....	38
2.7 Connectors .....	43
Power Connections .....	43
Headers .....	45
2.8 Jumper Settings .....	54
How Jumpers Work .....	54
2.9 LED Indicators .....	60
<b>Chapter 3 Troubleshooting</b>	
3.1 Troubleshooting Procedures .....	63
3.2 Technical Support Procedures .....	67
3.3 Frequently Asked Questions .....	68
3.4 Battery Removal and Installation .....	69
<b>Chapter 4 BIOS</b>	
4.1 Introduction .....	71
4.2 Main Setup .....	72
4.3 Advanced Setup Configurations .....	74
4.4 Event Logs .....	96
4.5 IPMI .....	97
4.6 Security .....	100
4.7 Boot .....	102
4.8 Save & Exit .....	104
<b>Appendix A BIOS Codes</b>	
<b>Appendix B Software Installation</b>	
B.1 Installing Software Programs .....	107
B.2 SuperDoctor® 5 .....	108
<b>Appendix C Standardized Warning Statements</b>	
Battery Handling .....	109
Product Disposal .....	111
<b>Appendix D UEFI BIOS Recovery</b>	
<b>Appendix E Dual Boot Block</b>	
BIOS Boot Block .....	116
BIOS Boot Block Corruption Occurrence .....	116

---

# Chapter 1

## Introduction

Congratulations on purchasing your computer motherboard from an industry leader. Supermicro boards are designed to provide you with the highest standards in quality and performance.

Several important parts that are included with the motherboard are listed below. If anything listed is damaged or missing, please contact your retailer.

### 1.1 Checklist

Main Parts List		
Description	Part Number	Quantity
Supermicro Motherboard	X11SSL-CF/-nF	1
SATA Cables	CBL-0044L	6
I/O Shield	MCP-260-00042-0N	1
Quick Reference Guide	MNL-1778-QRG	1

### Important Links

For your system to work properly, please follow the links below to download all necessary drivers/utilities and the user's manual for your server.

- Supermicro product manuals: <http://www.supermicro.com/support/manuals/>
- Product drivers and utilities: <ftp://ftp.supermicro.com>
- Product safety info: [http://www.supermicro.com/about/policies/safety\\_information.cfm](http://www.supermicro.com/about/policies/safety_information.cfm)
- If you have any questions, please contact our support team at: [support@supermicro.com](mailto:support@supermicro.com)

This manual may be periodically updated without notice. Please check the Supermicro website for possible updates to the manual revision level.

Figure 1-1. X11SSL-CF Motherboard Image

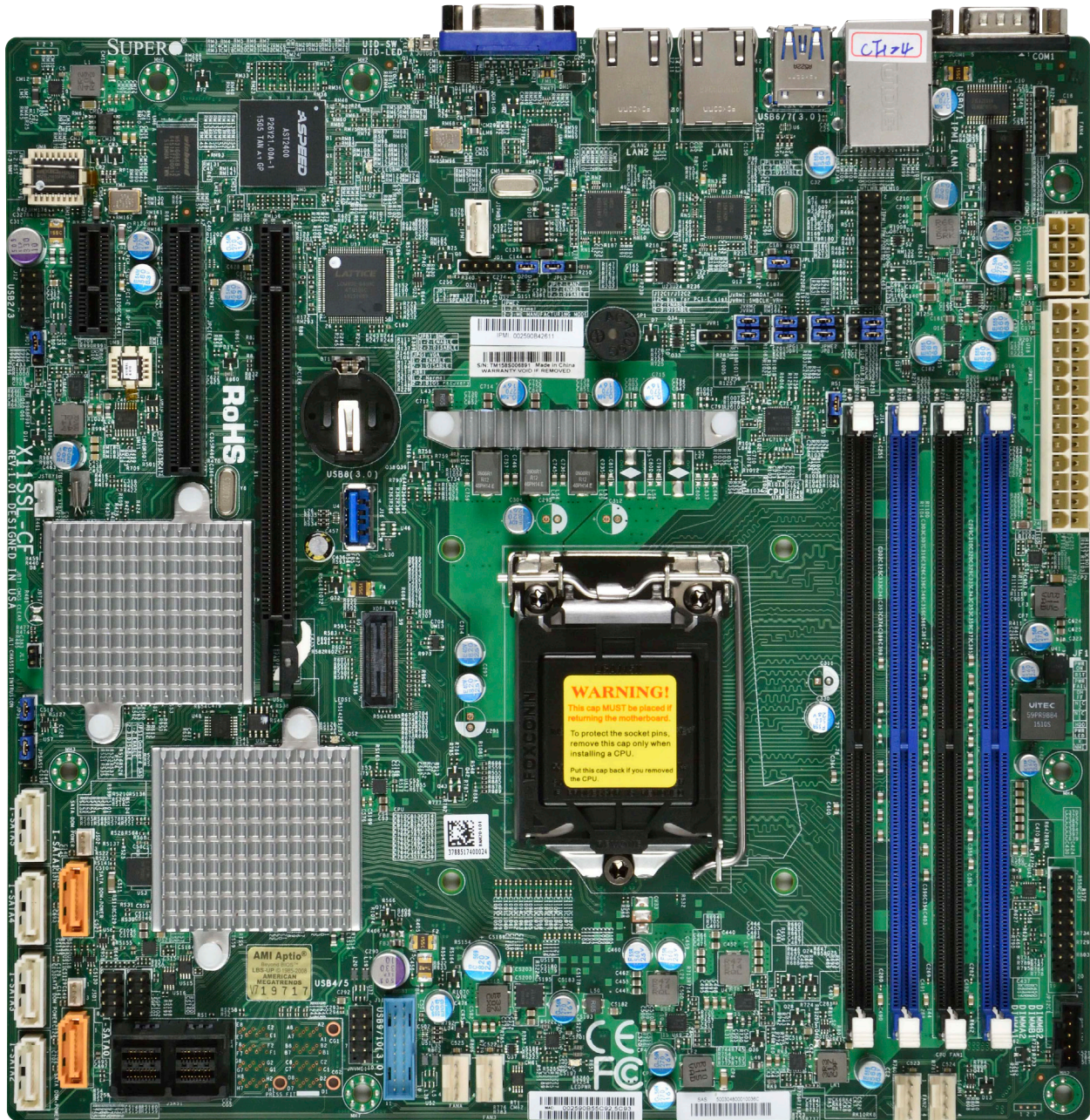

**Note:** All graphics shown in this manual were based upon the latest PCB revision available at the time of publication of the manual. The motherboard you received may or may not look exactly the same as the graphics shown in this manual.



Figure 1-2. X11SSL-nF Motherboard Image

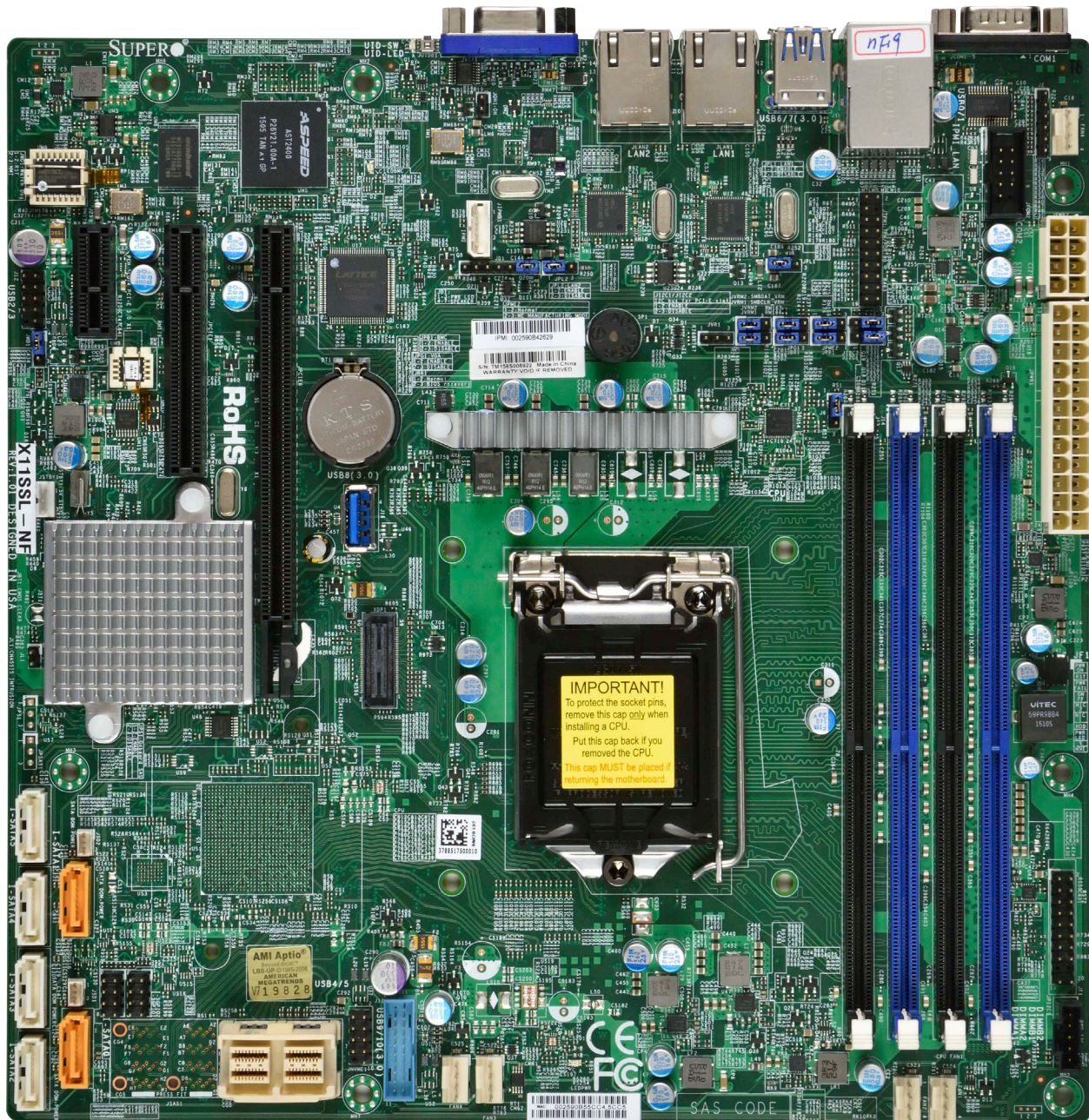





## Quick Reference Table

Jumper	Description	Default Setting
JBR1	BIOS Recovery	Pins 1-2 (Normal)
JBT1	Clear CMOS	See Chapter 2
JI2C1/JI2C2	SMB to PCI Slots	Pins 2-3 (Disabled)
JPB1	BMC Enable/Disable	Pins 1-2 (Enabled)
JPG1	VGA Enable	Pins 1-2 (Enabled)
JPL1/JPL2	LAN1/LAN2 Enable	Pins 1-2 (Enabled)
JPME2	Manufacturing Mode Select	Pins 1-2 (Normal)
JPS1	SAS Enable	Pins 1-2 (Enabled)
JWD1	Watch Dog Enable	Pins 1-2 (Reset)

LED	Description	Status
LE1	Rear UID LED	Blue: On; Unit Identified
LEDBMC	BMC Heartbeat LED	Green: Blinking; BMC Normal
LEDPWR	System Power LED	Green: Solid On
LEDS1	SAS LED	Green Blinking; SAS Active Red; SAS Error

Connector	Description
BT1	Onboard Battery
COM1/COM2	COM1/COM2 Port Headers
Fan1-Fan4, FanA	System/CPU Fan Headers
IPMI_LAN	Dedicated IPMI Gigabit (RJ45) Port
I-SATA0-I-SATA5	SATA 3.0 Connectors via Intel PCH (6Gb/s)
I-SGPIO 1/2	Serial_Link General Purpose I/O Connection Headers for I-SATA 3.0 connections
JD1	Speaker/Power LED Indicator
JF1	Front Panel Control Header
JIPMB1	4-pin External BMC I2C Header (for an IPMI Card)
JL1	Chassis Intrusion Header
JNVME1	Two (2) NVMe SSD Ports (X11SSL-nF Only)
JOH1	Overheat LED Indicator
JPI2C1	Power I2C System Management Bus (Power SMB) Header
JPWR1	24-pin ATX Main Power Connector (Required)
JPWR2	+12V 8-pin CPU Power Connector (Required)
JSAS1	Two (2) Mini-SAS HD Ports (X11SSL-CF Only)
JSD1/JSD2	SATA Disk On Module (DOM) Power Connectors
JSTBY1	Wake-On-LAN Enable Header
JTPM1	Trusted Platform Module/Port 80 Connector
JUIDB1	UID (Unit Identification) Switch





**Note:** Table is continued on the next page.

---

---

<b>Connector</b>	<b>Description</b>
LAN1/LAN2	Gigabit (RJ45) LAN Ports
PCI-E (CPU) Slot 6	PCI-Express 3.0 x8 in x16 Slot
PCI-E (PCH) Slot 5	PCI-Express 3.0 x4 in x8 Slot
PCI-E (PCH) Slot 4	PCI-Express 3.0 x1 Slot
SP1	Internal Speaker/Buzzer
USB 0/1	Back Panel USB 2.0 Ports
USB 2/3, USB 4/5	Front Accessible USB 2.0 Headers
USB 6/7	Back Panel USB 3.0 Ports
USB 8	USB 3.0 Type-A Header
USB 9/10	Front Accessible USB 3.0 Header
VGA	Back Panel VGA Port

## Motherboard Features

<b>Motherboard Features</b>	
<b>CPU</b>	
<ul style="list-style-type: none"> <li>Intel® Xeon® E3-1200 v5 and 6th Gen Core™ i3, Pentium and Celeron processors in an LGA 1151 (H4) socket. 80W max TDP.</li> </ul>	
<b>Memory</b>	
<ul style="list-style-type: none"> <li>Four (4) 288-pin DIMM slots support up to 64 GB of SDRAM 72-bit DDR4 unbuffered ECC 2133/1866/1600/1333MHz memory.</li> </ul>	
<b>DIMM Size</b>	
<ul style="list-style-type: none"> <li>16GB, 8GB, and 4GB, up to 64GB at 1.2V</li> </ul>	
 <b>Note 1:</b> Memory speed support depends on the processors used in the system.	
 <b>Note 2:</b> For the latest CPU/memory updates, please refer to our website at <a href="http://www.supermicro.com/products/motherboard">http://www.supermicro.com/products/motherboard</a> .	
<b>Chipset</b>	
<ul style="list-style-type: none"> <li>Intel® PCH C232</li> </ul>	
<b>Expansion Slots</b>	
<ul style="list-style-type: none"> <li>One (1) PCI Express 3.0 x1 slot (PCH Slot 4)</li> <li>One (1) PCI Express 3.0 x4 in x8 (PCH Slot 5)</li> <li>One (1) PCI Express 3.0 x8 in x16 slot (CPU Slot 6)</li> </ul>	
<b>Network</b>	
<ul style="list-style-type: none"> <li>Intel® i210 AT Gigabit Ethernet Controllers for LAN1/LAN2</li> </ul>	
<b>Baseboard Management Controller (BMC)</b>	
<ul style="list-style-type: none"> <li>Aspeed 2400 Baseboard Management Controller (BMC) supports IPMI 2.0</li> </ul>	
<b>Graphics</b>	
<ul style="list-style-type: none"> <li>Graphics controller via Aspeed AST2400 BMC</li> </ul>	
<b>I/O Devices</b>	
<ul style="list-style-type: none"> <li>Serial (COM) Port</li> </ul>	<ul style="list-style-type: none"> <li>One (1) serial port on the rear I/O panel (COM1)</li> <li>One (1) front accessible serial port header (COM2)</li> </ul>
<ul style="list-style-type: none"> <li>SATA 3.0               <ul style="list-style-type: none"> <li>RAID</li> </ul> </li> </ul>	<ul style="list-style-type: none"> <li>Six (6) I-SATA 3.0 ports (I-SATA 0-5)</li> <li>Two (2) SuperDOM connectors (I-SATA0 &amp; I-SATA1)</li> <li>0, 1, 5, 10</li> </ul>
<ul style="list-style-type: none"> <li>Mini-SAS HD (X11SSL-CF only)               <ul style="list-style-type: none"> <li>RAID</li> </ul> </li> </ul>	<ul style="list-style-type: none"> <li>Two (2) mini-SAS HD connections</li> <li>0, 1, and 10</li> </ul>
<ul style="list-style-type: none"> <li>NVMe (X11SSL-nF only)</li> </ul>	<ul style="list-style-type: none"> <li>Two (2) NVMe SSD ports</li> </ul>



**Note:** The table above is continued on the next page.

## Motherboard Features

### Peripheral Devices

- Two (2) USB 2.0 ports on the rear I/O panel (USB 0/1)
- Two (2) front accessible USB 2.0 headers (USB 2/3, USB 4/5)
- Two (2) USB 3.0 ports on the rear I/O panel (USB 6/7)
- One (1) Type-A USB 3.0 header (USB 8)
- One (1) front accessible USB 3.0 header (USB 9/10)

### BIOS

- 128Mb AMI BIOS® SPI Flash BIOS
- Real Time Clock wakeup, dual boot block, Riser Card auto-detection support, Plug and Play (PnP), DMI 3.0, ACPI 4.0+, USB Keyboard and SMBIOS 2.7+, and BIOS rescue hot-key.

### Power Management

- ACPI Power Management
- Keyboard Wakeup from Soft-Off
- CPU fan auto-off in sleep mode
- Main Switch Override Mechanism
- Wake-On-LAN (WOL)
- Power-on mode for AC power recovery
- Server Platform Service

### System Health Monitoring

- Onboard voltage monitors for: CPU cores, +3.3V, +5V, +12V, +5V Stdby, VBAT, HT, memory, and PCH temperature.
- CPU 3-phase switching voltage regulator
- CPU/System overheat control
- CPU Thermal Trip support
- Thermal Monitor 2 (TM2) support

### Fan Control

- Fan status monitoring with firmware 4-pin fan speed control via IPMI interface
- Fan speed control

### System Management

- PECCI (Platform Environment Configuration Interface) 2.0 support
- IPMI 2.0 with KVM support
- SuperDoctor® 5, Watch Dog, NMI
- Chassis Intrusion header and detection

### LED Indicators

- CPU/overheating
- Power indicator
- Fan failed
- UID/remote UID
- HDD activity
- LAN activity



**Note:** The table above is continued on the next page.

## Motherboard Features

### Other

- RoHS

### Dimensions

- Micro ATX form factor (9.6" x 9.6") (243.84 mm x 243.84 mm)

 **Note 1:** The CPU maximum thermal design power (TDP) is subject to chassis and heatsink cooling restrictions. For proper thermal management, please check the chassis and heatsink specifications for proper CPU TDP sizing.

**Note 2:** For IPMI configuration instructions, please refer to the Embedded IPMI Configuration User's Guide available at <http://www.supermicro.com/support/manuals/>.



**Figure 1-4.**  
**System Block Diagram**

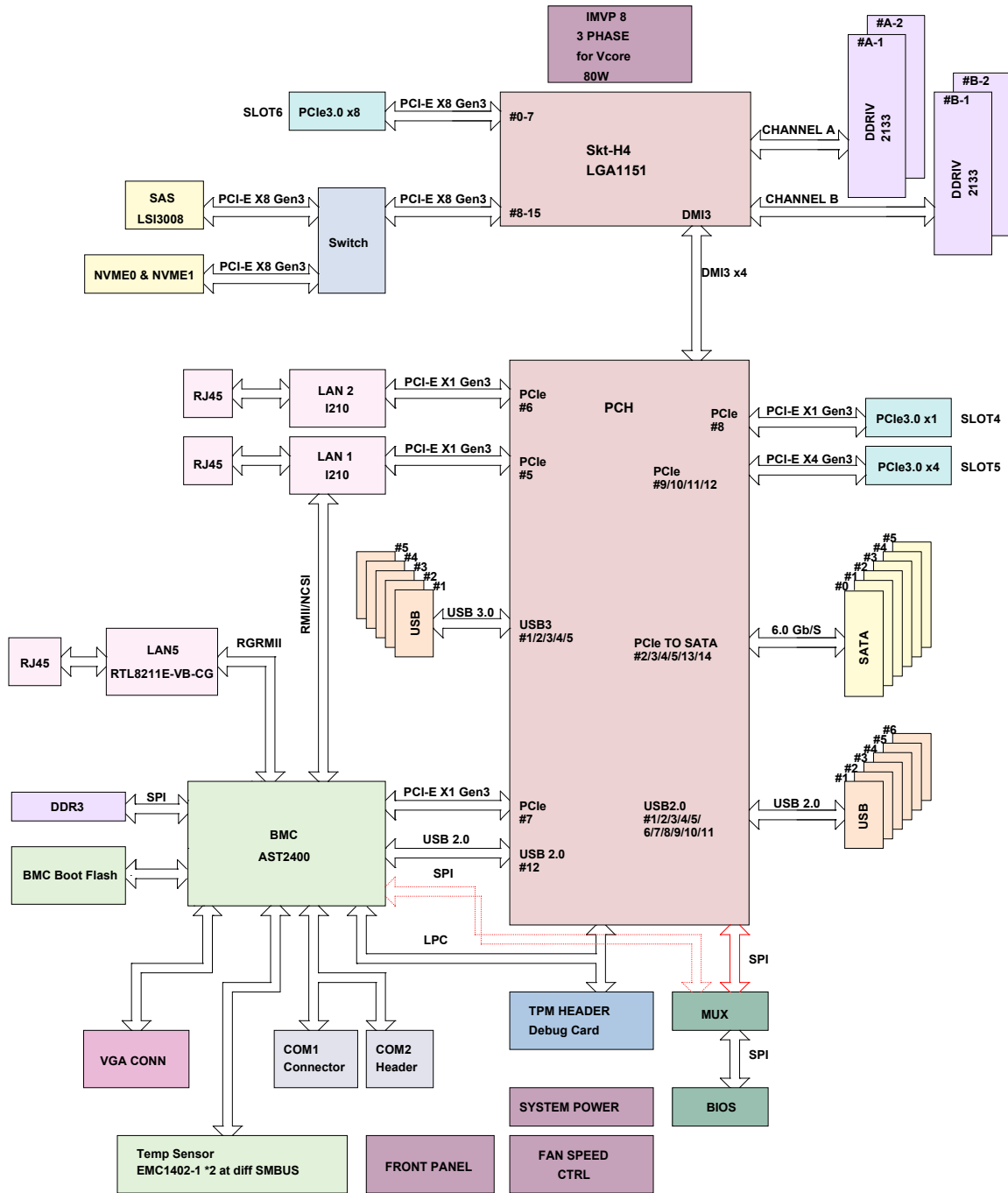

**Note:** This is a general block diagram and may not exactly represent the features on your motherboard. See the previous pages for the actual specifications of your motherboard.

## 1.2 Processor and Chipset Overview

Built upon the functionality and capability of the Intel E3-1200 v5 series processors (Socket LGA 1151) and the Intel C232 PCH, the X11SSL-CF/-nF motherboard offers maximum I/O expandability, energy efficiency, and data reliability in a 14-nm process architecture, and is optimized for embedded storage solutions, networking applications, or cloud-computing platforms.

The Intel E3-1200 V5 and PCH C232 platform supports the following features:

- ACPI Power Management Logic Support, Rev. 4.0a
- Intel® Turbo Boost Technology 2.0 Power Monitoring/Power Control, Turbo Time Parameter (TAU), and Platform Power Control
- Configurable TDP (cTDP) and Lower-Power Mode
- Adaptive Thermal Management/Monitoring
- PCI-E 3.0, SATA 3.0 w/transfer rates of up to 6 Gb/s, xHCI USB w/SuperSpeed 3.0
- System Management Bus (SMBus) Specification, Version 2.0
- Integrated Sensor Hub (ISH)
- Intel Trusted Execution Technology (Intel TXT)
- Intel Rapid Storage Technology
- Intel Virtualization Technology for Directed I/O (Intel VT-d)

## 1.3 Special Features

This section describes the health monitoring features of the X11SSL-CF/-nF motherboard. The motherboard has an onboard System Hardware Monitor chip that supports system health monitoring.

### Recovery from AC Power Loss

The Basic I/O System (BIOS) provides a setting that determines how the system will respond when AC power is lost and then restored to the system. You can choose for the system to remain powered off (in which case you must press the power switch to turn it back on), or for it to automatically return to the power-on state. See the Advanced BIOS Setup section for this setting. The default setting is **Last State**.

## 1.4 System Health Monitoring

This motherboard has an onboard Baseboard Management Controller (BMC) chip that supports system health monitoring.

### Onboard Voltage Monitors

An onboard voltage monitor will scan the voltages of onboard chipset, memory, CPU, and battery continuously. Once a voltage becomes unstable, a warning is given, or an error message is sent to the screen. The user can adjust the voltage thresholds to define the sensitivity of the voltage monitor.

### Fan Status Monitor with Firmware Control

The system health monitor chip can check the RPM status of a cooling fan. The CPU and chassis fans are controlled by BIOS Thermal Management through the back panel.

### Environmental Temperature Control

System Health sensors monitor temperatures and voltage settings of onboard processors and the system in real time via the IPMI interface. Whenever the temperature of the CPU or the system exceeds a user-defined threshold, system/CPU cooling fans will be turned on to prevent the CPU or the system from overheating



**Note:** To avoid possible system overheating, please be sure to provide adequate air-flow to your system.

### System Resource Alert

This feature is available when used with SuperDoctor 5® in the Windows OS or in the Linux environment. SuperDoctor is used to notify the user of certain system events. For example, you can configure SuperDoctor to provide you with warnings when the system temperature, CPU temperatures, voltages and fan speeds go beyond a predefined range.

## 1.5 ACPI Features

ACPI stands for Advanced Configuration and Power Interface. The ACPI specification defines a flexible and abstract hardware interface that provides a standard way to integrate power management features throughout a computer system, including its hardware, operating system and application software. This enables the system to automatically turn on and off peripherals such as CD-ROMs, network cards, hard disk drives and printers.

In addition to enabling operating system-directed power management, ACPI also provides a generic system event mechanism for Plug and Play, and an operating system-independent interface for configuration control. ACPI leverages the Plug and Play BIOS data structures, while providing a processor architecture-independent implementation that is compatible with Windows 7, Windows 8, and Windows 2012 Operating Systems.

## 1.6 Power Supply

As with all computer products, a stable power source is necessary for proper and reliable operation. It is even more important for processors that have high CPU clock rates.

The X11SSL-CF/-nF motherboard accommodates 24-pin ATX power supplies. Although most power supplies generally meet the specifications required by the CPU, some are inadequate. In addition, One 12V 8-pin power connection is also required to ensure adequate power supply to the system.

**Warning:** To avoid damaging the power supply or the motherboard, be sure to use a power supply that contains a 24-pin and an 8-pin power connector. Be sure to connect the power supplies to the 24-pin power connector (JPWR1), and the 8-pin power connector (JPWR2) on the motherboard. Failure in doing so may void the manufacturer warranty on your power supply and motherboard.

It is strongly recommended that you use a high quality power supply that meets ATX power supply Specification 2.02 or above. It must also be SSI compliant. (For more information, please refer to the website at <http://www.ssiforum.org/>). Additionally, in areas where noisy power transmission is present, you may choose to install a line filter to shield the computer from noise. It is recommended that you also install a power surge protector to help avoid problems caused by power surges.

## 1.7 Serial Port

The X11SSL-CF/-nF motherboard supports two serial communication connections. COM Ports 1 and 2 can be used for input/output. The UART provides legacy speeds with a baud rate of up to 115.2 Kbps as well as an advanced speed with baud rates of 250 K, 500 K, or 1 Mb/s, which support high-speed serial communication devices. 115.2 Kbps as well as an advanced speed with baud rates of 250 K, 500 K, or 1 Mb/s, which support higher speed modems.

# Chapter 2

## Installation

### 2.1 Static-Sensitive Devices

Electrostatic Discharge (ESD) can damage electronic components. To prevent damage to your motherboard, it is important to handle it very carefully. The following measures are generally sufficient to protect your equipment from ESD.

#### Precautions

- Use a grounded wrist strap designed to prevent static discharge.
- Touch a grounded metal object before removing the board from the antistatic bag.
- Handle the board by its edges only; do not touch its components, peripheral chips, memory modules or gold contacts.
- When handling chips or modules, avoid touching their pins.
- Put the motherboard and peripherals back into their antistatic bags when not in use.
- For grounding purposes, make sure that your chassis provides excellent conductivity between the power supply, the case, the mounting fasteners and the motherboard.
- Use only the correct type of CMOS onboard battery as specified by the manufacturer. Do not install the CMOS battery upside down, which may result in a possible explosion.

#### Unpacking

The motherboard is shipped in antistatic packaging to avoid static damage. When unpacking the motherboard, make sure that the person handling it is static protected.

## 2.2 Motherboard Installation

All motherboards have standard mounting holes to fit different types of chassis. Make sure that the locations of all the mounting holes for both the motherboard and the chassis match. Although a chassis may have both plastic and metal mounting fasteners, metal ones are highly recommended because they ground the motherboard to the chassis. Make sure that the metal standoffs click in or are screwed in tightly.



**Philips  
Screwdriver  
(1)**



**Philips Screws  
(7)**



**Standoffs (7)  
Only if Needed**

### Tools Needed

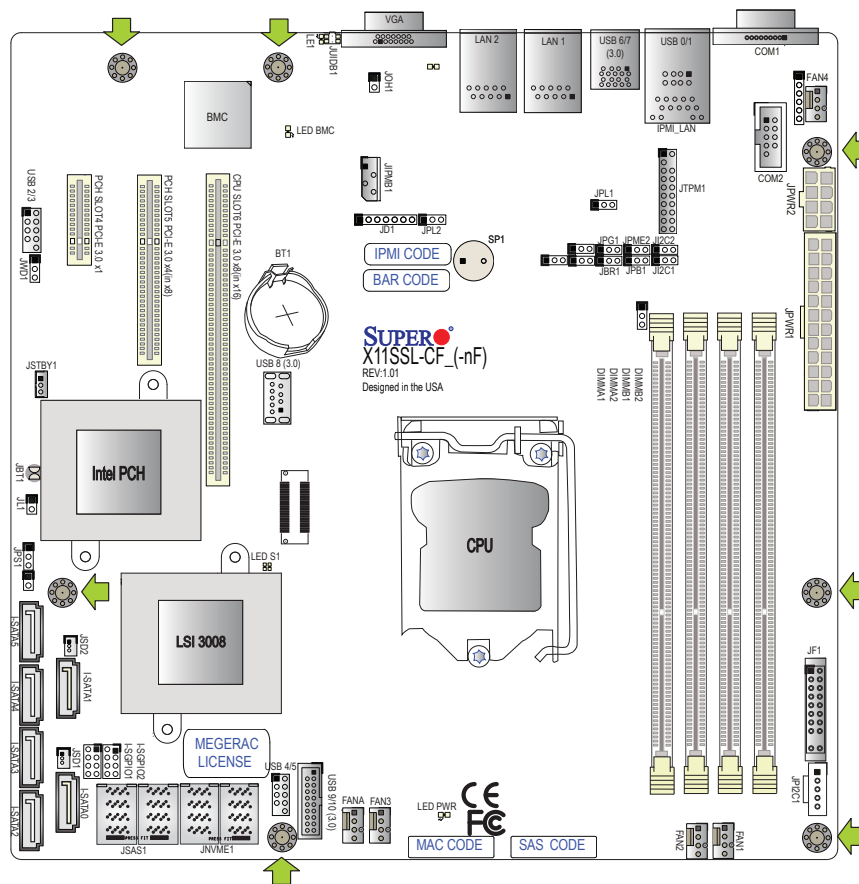

### Location of Mounting Holes



- Note:** 1) To avoid damaging the motherboard and its components, please do not use a force greater than 8 lb/inch on each mounting screw during motherboard installation.
- 2) Some components are very close to the mounting holes. Please take precautionary measures to avoid damaging these components when installing the motherboard to the chassis.

## Installing the Motherboard

1. Install the I/O shield into the back of the chassis.

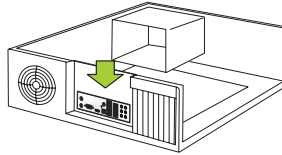

2. Locate the mounting holes on the motherboard. See the previous page for the location.

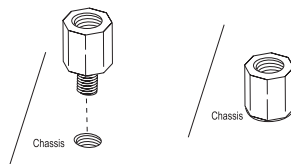

3. Locate the matching mounting holes on the chassis. Align the mounting holes on the motherboard against the mounting holes on the chassis.

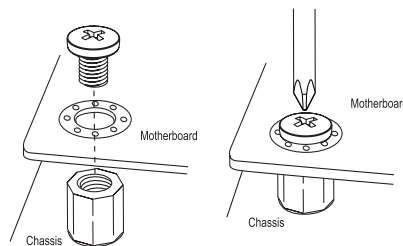

4. Install standoffs in the chassis as needed.
5. Install the motherboard into the chassis carefully to avoid damaging other motherboard components.
6. Using the Phillips screwdriver, insert a Phillips head #6 screw into a mounting hole on the motherboard and its matching mounting hole on the chassis.
7. Repeat Step 5 to insert #6 screws into all mounting holes.
8. Make sure that the motherboard is securely placed in the chassis.

 **Note:** Images displayed are for illustration only. Your chassis or components might look different from those shown in this manual.

## 2.3 Processor and Heatsink Installation

**Warning:** When handling the processor package, avoid placing direct pressure on the label area of the fan.



### Important:

- Always connect the power cord last, and always remove it before adding, removing or changing any hardware components. Make sure that you install the processor into the CPU socket before you install the CPU heatsink.
- If you buy a CPU separately, make sure that you use an Intel-certified multi-directional heatsink only.
- Make sure to install the motherboard into the chassis before you install the CPU heatsink.
- When receiving a motherboard without a processor pre-installed, make sure that the plastic CPU socket cap is in place and none of the socket pins are bent; otherwise, contact your retailer immediately.
- Refer to the Supermicro website for updates on CPU support.

### Installing the LGA1151 Processor

1. Press the load lever to release the load plate, which covers the CPU socket, from its locking position.

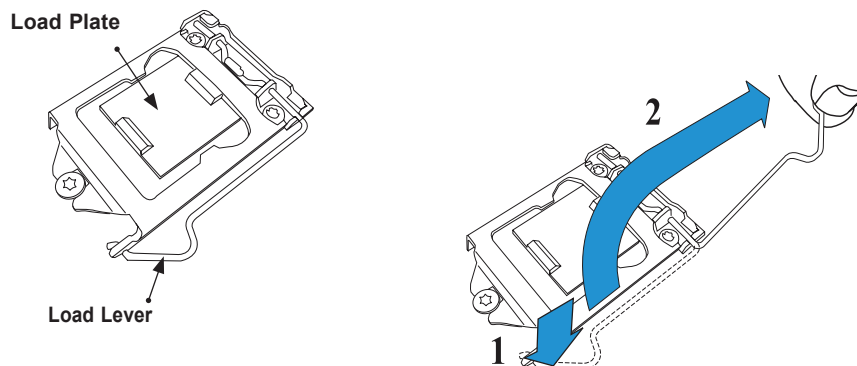



2. Gently lift the load lever to open the load plate. Remove the plastic cap.

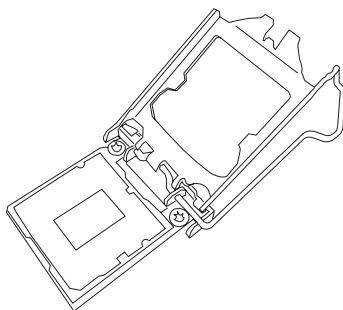

3. Use your thumb and your index finger to hold the CPU at the North center edge and the South center edge of the CPU.

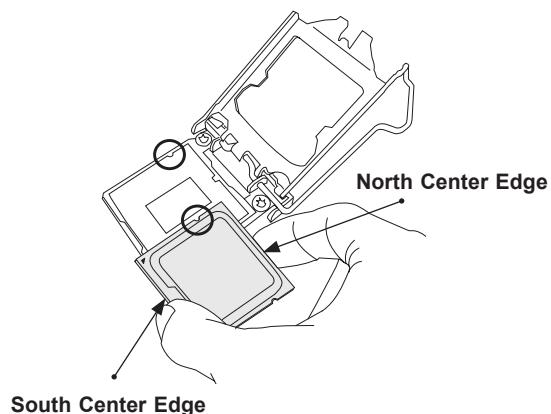

4. Align the CPU key that is the semi-circle cutouts against the socket keys. Once it is aligned, carefully lower the CPU straight down into the socket. (Do not drop the CPU on the socket. Do not move the CPU horizontally or vertically).

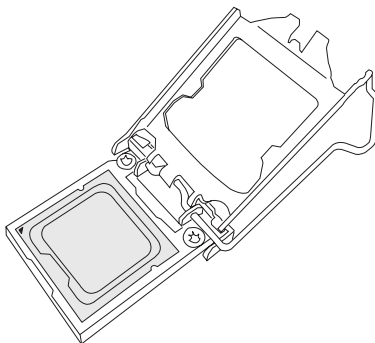

5. Do not rub the CPU against the surface or against any pins of the socket to avoid damaging the CPU or the socket.

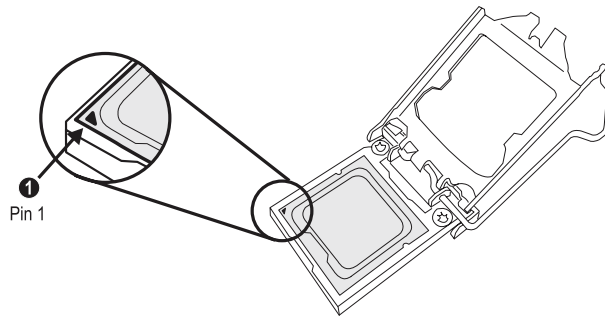

6. With the CPU inside the socket, inspect the four corners of the CPU to make sure that the CPU is properly installed.
7. Use your thumb to gently push the load lever down to the lever lock.

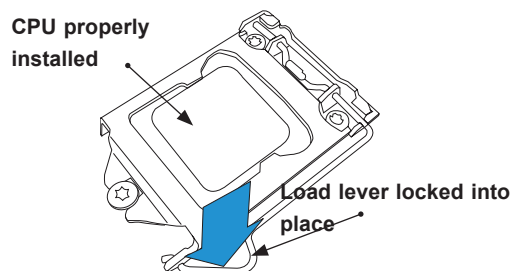

 **Note:** You can only install the CPU inside the socket in one direction. Make sure that it is properly inserted into the CPU socket before closing the load plate. If it doesn't close properly, do not force it as it may damage your CPU. Instead, open the load plate again and double-check that the CPU is aligned properly.

## Installing an Active CPU Heatsink with Fan

1. Locate the CPU fan power connector on the motherboard. (Refer to the layout on the right for the CPU Fan location.)
2. Position the heatsink so that the heatsink fan wires are closest to the CPU fan power connector and are not interfered with other components.
3. Inspect the CPU fan wires to make sure that the wires are routed through the bottom of the heatsink.
4. Remove the thin layer of the protective film from the heatsink.



**Important:** CPU overheating may occur if the protective film is not removed from the heatsink.

5. Apply the proper amount of thermal grease on the CPU.



**Note:** If your heatsink came with a thermal pad, please ignore this step.

6. If necessary, rearrange the wires to make sure that the wires are not pinched between the heatsink and the CPU. Also make sure to keep clearance between the fan wires and the fins of the heatsink.

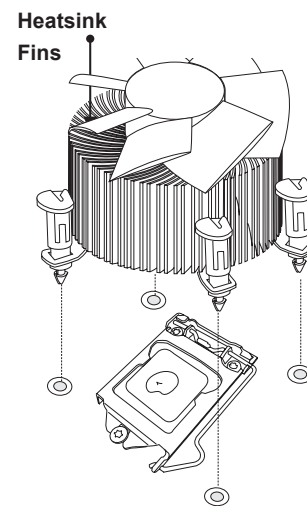
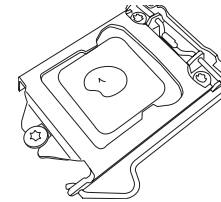
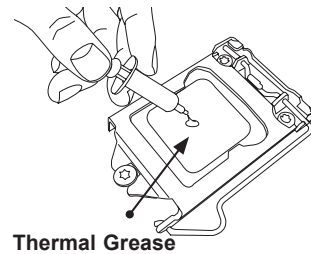

**Recommended Supermicro  
heatsink:  
SNK-P0046A4 or SNK-P0051AP4  
active heatsink  
(2U+ or 4U chassis)**

7. Align the four heatsink fasteners with the mounting holes on the motherboard. Gently push the pairs of diagonal fasteners (#1 & #2, and #3 & #4) into the mounting holes until you hear a click. Also, make sure to orient each fastener so that the narrow end of the groove is pointing outward.
8. Repeat step 7 to insert all four heatsink fasteners into the mounting holes.
9. Once all four fasteners are securely inserted into the mounting holes, and the heatsink is properly installed on the motherboard, connect the heatsink fan wires to the CPU fan connector.

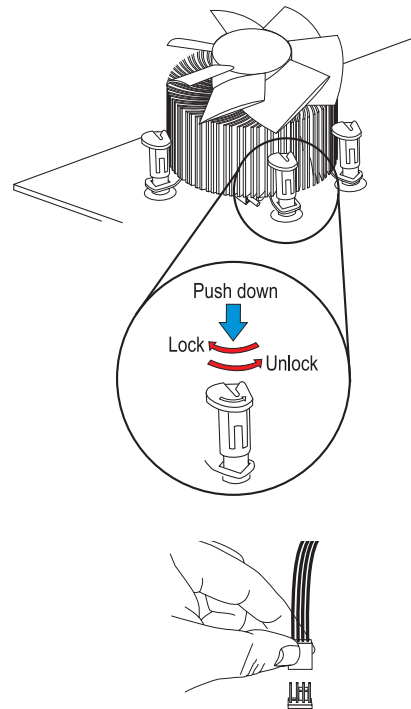

## Removing the Heatsink

 **Note:** We do not recommend that the CPU or the heatsink be removed. However, if you do need to remove the heatsink, please follow the instructions below to remove the heatsink and to prevent damage done to the CPU or other components.

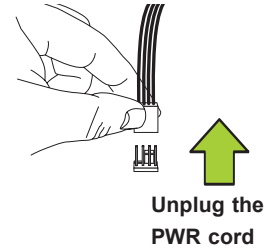

### *Active Heatsink Removal*

1. Unplug the power cord from the power supply.
2. Disconnect the heatsink fan wires from the CPU fan header.
3. Use your finger tips to gently press on the fastener cap and turn it counterclockwise to make a 1/4 (90°) turn, and pull the fastener upward to loosen it.
4. Repeat step 3 to loosen all fasteners from the mounting holes.
5. With all fasteners loosened, remove the heatsink from the CPU.

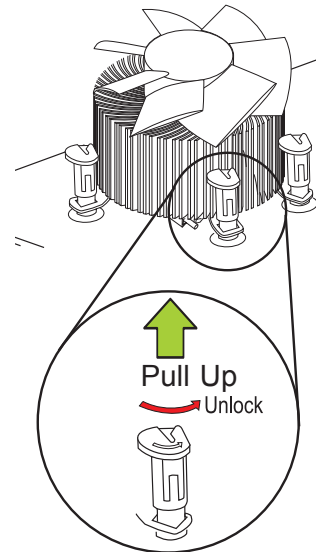

## 2.4 Memory Support and Installation



**Note:** Check the Supermicro website for recommended memory modules.



**Important:** Exercise extreme care when installing or removing DIMM modules to prevent any possible damage.

### Memory Support

The X11SSL-CF/-nF motherboard supports up to 64GB of unbuffered (UDIMM) DDR4 ECC 2133/1866/1600/1333MHz memory in four memory slots. Populating these DIMM slots with memory modules of the same type and size will result in interleaved memory, which will improve memory performance.

### DIMM Module Population Configuration

For optimal memory performance, follow the table below when populating memory.

Processors and their Corresponding Memory Modules				
CPU#	Corresponding DIMM Modules			
CPU	DIMMA1	DIMMA2	DIMMB1	DIMMB2

Memory Module Population for Optimal Performance	
Number of DIMMs	Memory Population Configuration Table (For memory to work properly, please follow the instructions below.)
2 DIMMs	DIMMB2/DIMMA2
4 DIMMs	DIMMB2/DIMMA2, DIMMB1/DIMMA1

Memory Module Population						
DIMM Slots per Channel	DIMM Type	POR Speeds (MHz)	Ranks per DIMM	Layer Count	FW Base	Supported Voltage
2	Unbuffered DDR4 ECC	2133, 1866, 1600, 1333	SR, DR	6	SPS	1.2V1

Memory Module Population		
Max Memory Possible	4GB DRAM Technology	8GB DRAM Technology
Single Rank UDIMM	16GB (4x 4GB DIMMs)	32GB (4x 8GB DIMMs)
Dual Rank UDIMMs	32GB (4x 8GB DIMMs)	64GB (4x 16GB DIMMs)

## DIMM Module Population Sequence

When installing memory modules, the DIMM slots should be populated in the following order: DIMMB2, DIMMA2, DIMMB1, DIMMA1.

- Always use DDR4 DIMM modules of the same type, size and speed.
- Mixed DIMM speeds can be installed. However, all DIMMs will run at the speed of the slowest DIMM.
- The motherboard will support odd-numbered modules (1 or 3 modules installed). However, for best memory performance, install DIMM modules in pairs to activate memory interleaving.

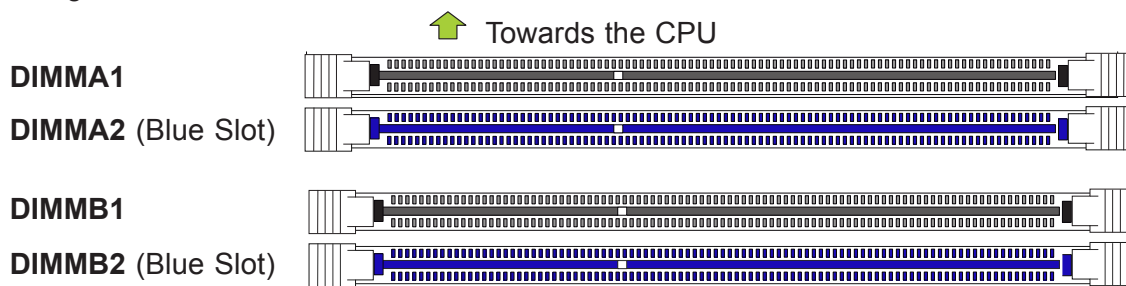

↓ Towards the edge of the motherboard

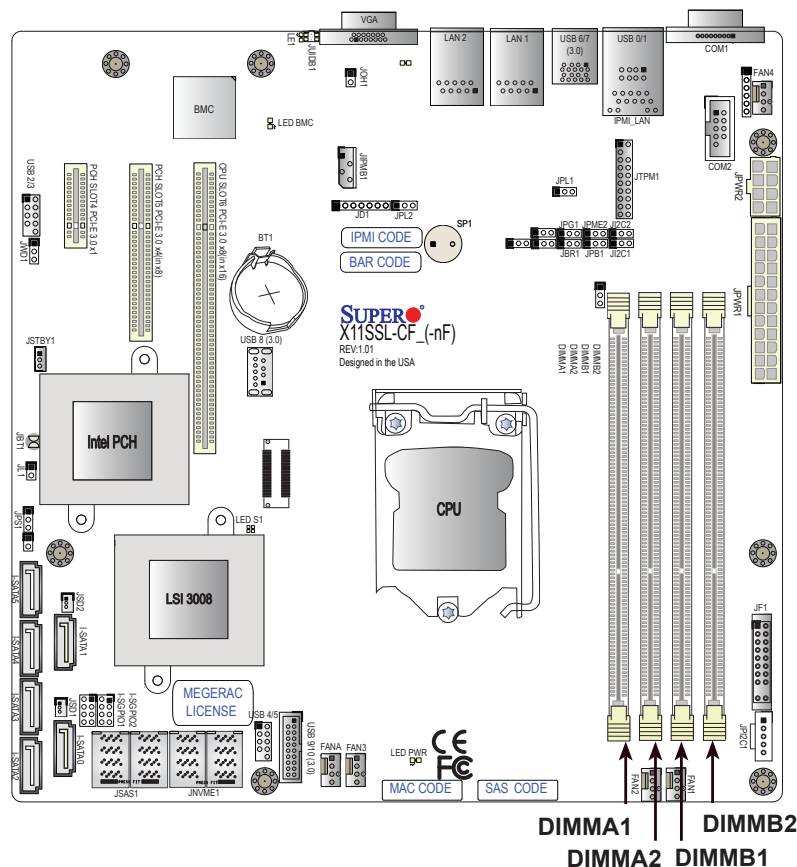

## DIMM Installation

1. Insert the desired number of DIMMs into the memory slots, starting with DIMMB2 (Channel B, Slot 2, blue slot). For best performance, please use the memory modules of the same type and speed in the same bank.
2. Push the release tabs outwards on both ends of the DIMM slot to unlock it.
3. Align the key of the DIMM module with the receptive point on the memory slot.
4. Align the notches on both ends of the module against the receptive points on the ends of the slot.
5. Use two thumbs together to press the notches on both ends of the module straight down into the slot until the module snaps into place.
6. Press the release tabs to the lock positions to secure the DIMM module into the slot.

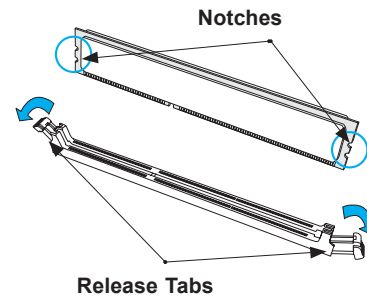
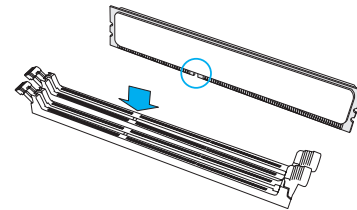
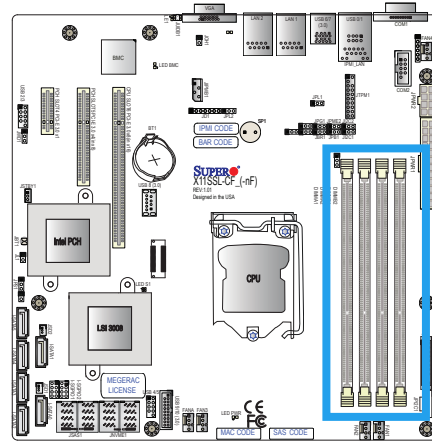

## DIMM Removal

Press both release tabs on the ends of the DIMM module to unlock it. Once the DIMM module is loosened, remove it from the memory slot.

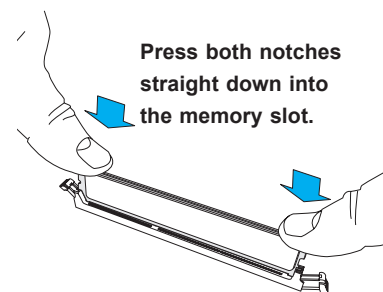



## 2.5 Rear I/O Ports

See Figure 2-2 below for the locations and descriptions of the various I/O ports on the rear of the motherboard.

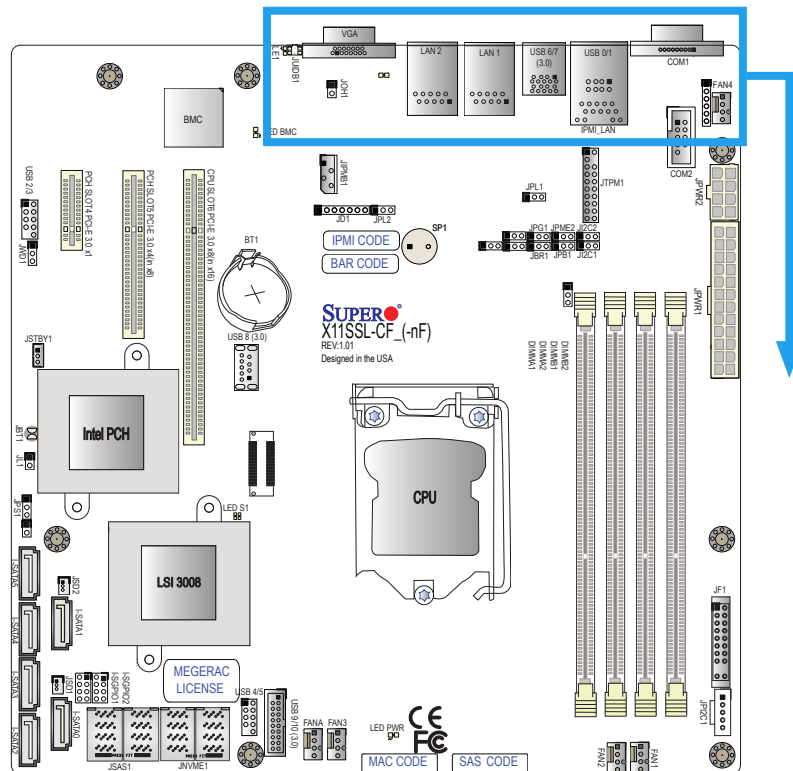
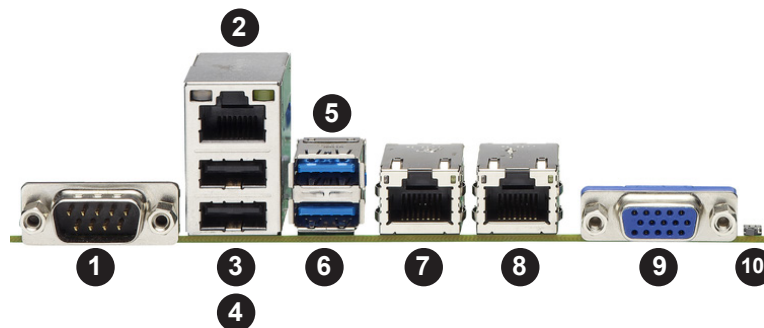

Figure 2-2. I/O Port Locations and Definitions



Rear I/O Ports			
#	Description	#	Description
1.	COM1 Port	6.	USB6 (3.0)
2.	IPMI LAN	7.	LAN1
3.	USB1	8.	LAN2
4.	USB0	9.	VGA Port
5.	USB7 (3.0)	10.	UID Switch

### VGA Port

A video (VGA) port is located next to LAN2 on the I/O back panel. Refer to the board layout below for the location.

### Serial Ports

Two COM connections (COM1 & COM2) are located on the motherboard. COM1 is located on the I/O back panel. COM2 is located next to COM1. Refer to the table below for pin definitions.

COM Port Pin Definitions			
Pin#	Definition	Pin#	Definition
1	DCD	6	DSR
2	RXD	7	RTS
3	TXD	8	CTS
4	DTR	9	RI
5	Ground	10	N/A

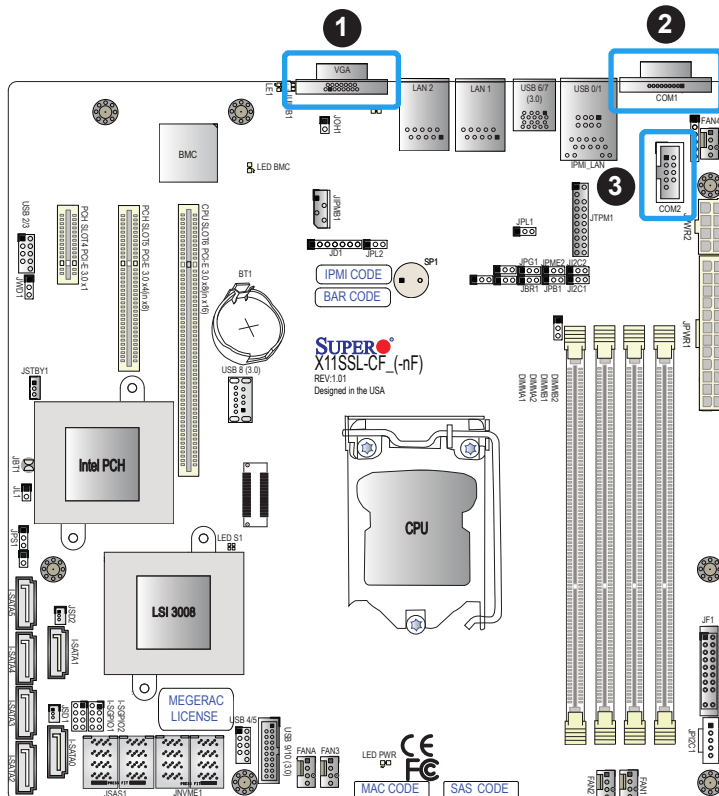

1. VGA Port
2. COM1
3. COM2

## LAN Ports

Two Gigabit Ethernet ports (LAN1 and LAN2) are located on the I/O back panel on the motherboard. In addition, a dedicated IPMI LAN is located above USB 0/1 ports on the back panel. All of these ports accept RJ45 cables. Please refer to the LED Indicator section for LAN LED information.

LAN Ports 1/2 Pin Definition			
Pin#	Definition	Pin#	Definition
1	TD0-	11	P3V3_Dual
2	TD0+	12	Act LED (Yellow)
3	TD1-	13	Link 1000 LED (Amber)
4	TD1+	14	Link 100 LED (Green)
5	TD2-	15	GND
6	TD2+	16	GND
7	TD3-	17	GND
8	TD3+	18	GND
9	COMMCT		
10	GND		

IPMI_LAN Pin Definition			
Pin#	Definition	Pin#	Definition
9		19	GND
10	TD0+	20	Act LED (Yellow)
11	TD0-	21	Link 100 LED (Green)
12	TD1+	22	Link 1000 LED (Amber)
13	TD1-	23	SGND
14	TD2+	24	SGND
15	TD2-	25	SGND
16	TD3+	26	SGND
17	TD3-		
18	GND		

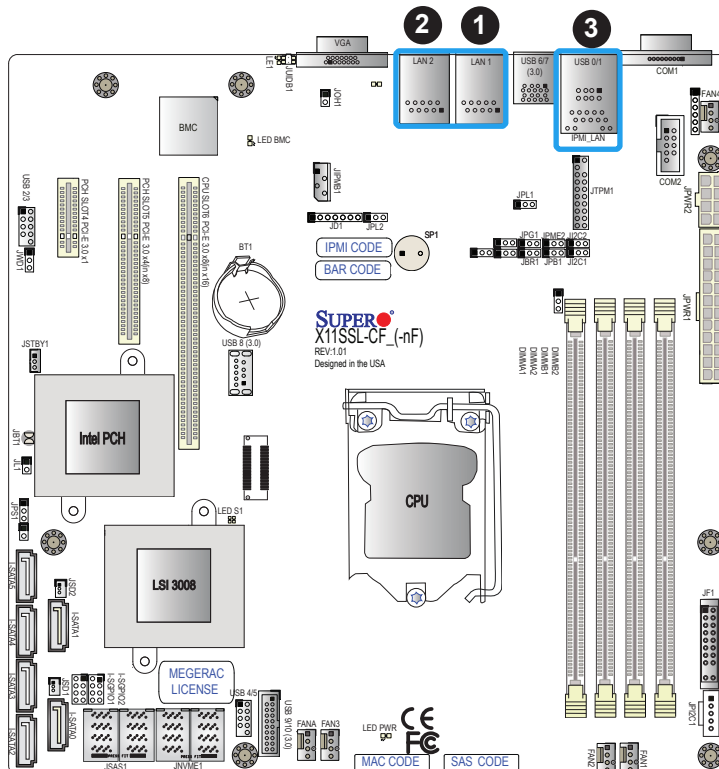

1. LAN1
2. LAN2
3. IPMI LAN

## Universal Serial Bus (USB) Ports

There are two USB 2.0 ports (USB0/1) and two USB 3.0 ports (USB6/7) located on the I/O back panel. The motherboard also has two front access USB 2.0 headers (USB2/3 and USB4/5) and one front access USB 3.0 header (USB9/10). Lastly, there is a USB 3.0 Type-A header (USB8). Cables are not included. See the tables below for pin definitions.

Back Panel USB 0/1 (2.0) Pin Definitions			
Pin#	Definition	Pin#	Definition
1	+5V	5	+5V
2	USB_N	6	USB_N
3	USB_P	7	USB_P
4	Ground	8	Ground

Front Panel USB 2/3, 4/5 (2.0) Pin Definitions			
Pin#	Definition	Pin#	Definition
1	+5V	2	+5V
3	USB_N	4	USB_N
5	USB_P	6	USB_P
7	Ground	8	Ground
9	Key	10	NC

Back Panel USB 6/7 (3.0) Pin Definitions			
Pin#	Definition	Pin#	Definition
1	VBUS	19	Power
2	Stda_SSRX-	18	USB3_RN
3	Stda_SSRX+	17	USB3_RP
4	GND	16	GND
5	Stda_SSTX-	15	USB3_TN
6	Stda_SSTX+	14	USB3_TP
7	GND	13	GND
8	D-	12	USB_N
9	D+	11	USB_P
10		x	

Type A USB 8 (3.0) Pin Definitions			
Pin#	Definition	Pin#	Definition
1	VBUS	5	SSRX-
2	USB_N	6	SSRX+
3	USB_P	7	GND
4	Ground	8	SSTX-
		9	SSTX+

Front Panel USB 9/10 (3.0) Pin Definitions			
Pin#	Definition	Pin#	Definition
A1	VBUS	B1	Power
A2	D-	B2	USB_N
A3	D+	B3	USB_P
A4	GND	B4	GND
A5	Stda_SSRX-	B5	USB3_RN
A6	Stda_SSRX+	B6	USB3_RP
A7	GND	B7	GND
A8	Stda_SSTX-	B8	USB3_TN
A9	Stda_SSTX+	B9	USB3_TP

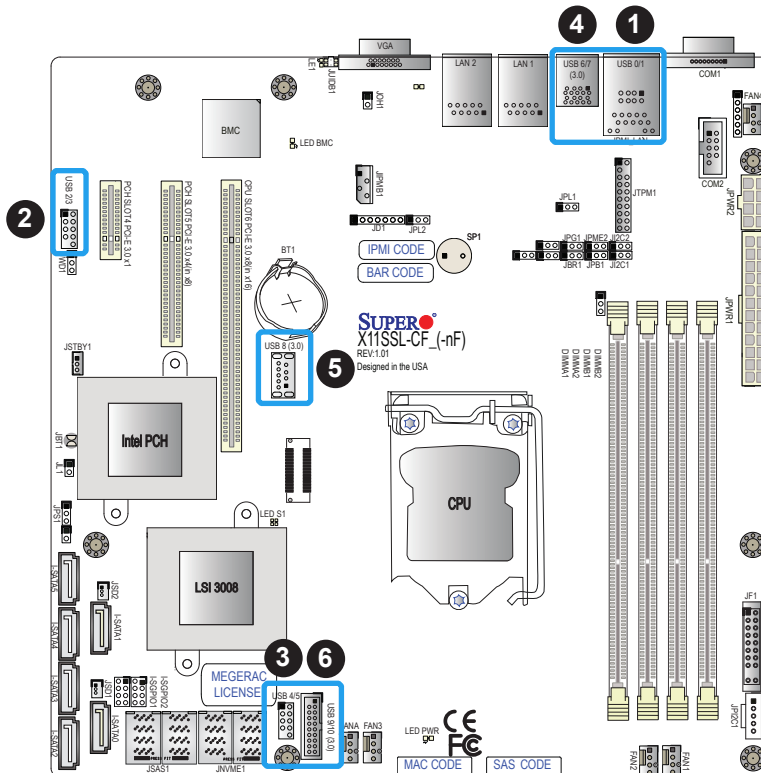

1. USB0/1
2. USB2/3
3. USB4/5
4. USB6/7
5. USB8
6. USB9/10

## 2.6 Front Control Panel

JF1 contains header pins for various buttons and indicators that are normally located on a control panel at the front of the chassis. These connectors are designed specifically for use with Supermicro chassis. See the figure below for the descriptions of the front control panel buttons and LED indicators.

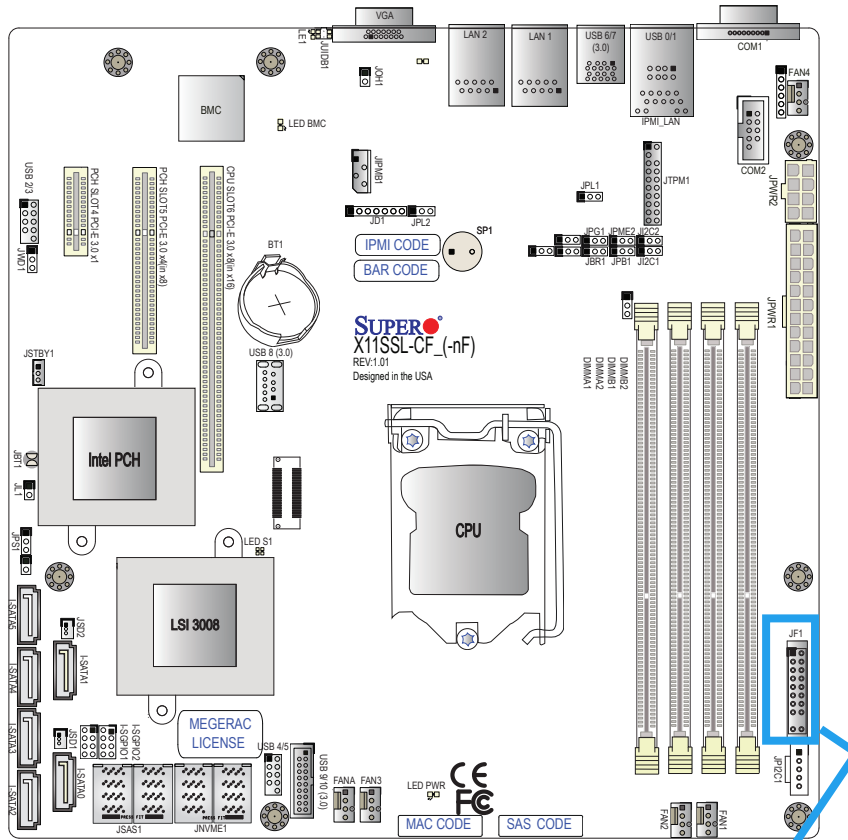

Figure 2-3. JF1 Header Pins

	1	2	
Power Button { PWR	○	○	Ground
Reset Button { Reset	○	○	Ground
X	○	○	X
Red+ (Blue LED Cathode)	○	○	Blue+ (OH/Fan Fail)
NIC2 Active LED	○	○	NIC2 Link LED
NIC1 Active LED	○	○	NIC1 Link LED
ID_UID_SW/3.3V Stdby	○	○	HDD LED
3.3 V	○	○	FP PWRLED
X	○	○	X
3.3V	○	○	Power Fail LED
	19	20	

## Power Button

The Power Button connection is located on pins 1 and 2 of JF1. Momentarily contacting both pins will power on/off the system. This button can also be configured to function as a suspend button (with a setting in the BIOS - see Chapter 4). To turn off the power when the system is in suspend mode, press the button for 4 seconds or longer. Refer to the table below for pin definitions.

Power Button Pin Definitions (JF1)	
Pin#	Definition
1	Signal
2	Ground

## Reset Button

The Reset Button connection is located on pins 3 and 4 of JF1. Attach it to a hardware reset switch on the computer case. Refer to the table below for pin definitions.

Reset Button Pin Definitions (JF1)	
Pin#	Definition
3	Reset
4	Ground

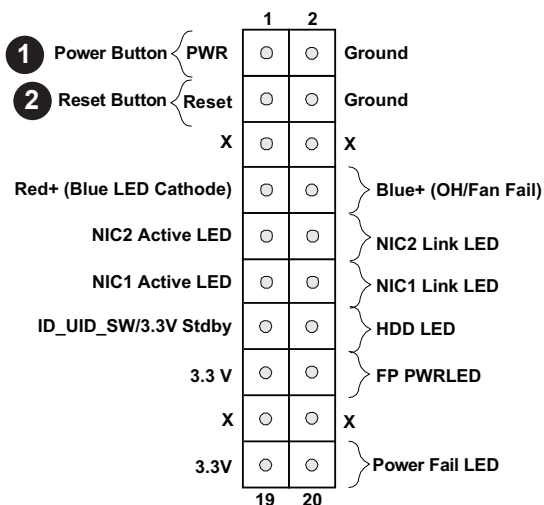

1. PWR Button

2. Reset Button

### Overheat (OH)/Fan Fail

Connect an LED cable to pins 7 and 8 of the Front Control Panel to use the Overheat/Fan Fail LED connections. The LED on pin 8 provides warnings of overheat or fan failure. Refer to the tables below for pin definitions.

OH/Fan Fail Indicator Status	
State	Definition
Off	Normal
On	Overheat
Flashing	Fan Fail

OH/Fan Fail LED Pin Definitions (JF1)	
Pin#	Definition
7	Blue LED
8	OH/Fan Fail LED

### NIC1/NIC2 (LAN1/LAN2)

The NIC (Network Interface Controller) LED connection for LAN port 2 is located on pins 9 and 10 of JF1, and the LED connection for LAN port 1 is on pins 11 and 12. Attach the NIC LED cables here to display network activity. Refer to the table below for pin definitions.

LAN1/LAN2 LED Pin Definitions (JF1)	
Pin#	Definition
9	NIC 2 Activity LED
10	NIC 2 Link LED
11	NIC 1 Activity LED
12	NIC 1 Link LED

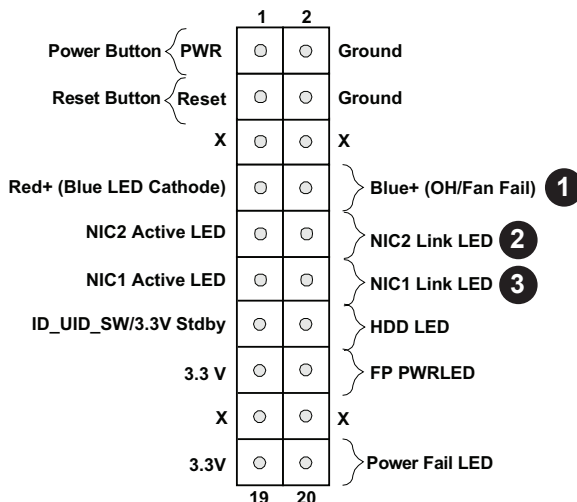

1. OH/Fan Fail LED
2. NIC2 LED
3. NIC1 LED



## HDD LED/UID Switch

The HDD LED/UID Switch connection is located on pins 13 and 14 of JF1. Attach a cable to pin 14 to show hard drive activity status. Attach a cable to pin 13 to use UID switch. Refer to the table below for pin definitions.

HDD LED Pin Definitions (JF1)	
Pin#	Definition
13	3.3V Stdby/UID_SW
14	HDD Active

## Power LED

The Power LED connection is located on pins 15 and 16 of JF1. Refer to the table below for pin definitions.

Power LED Pin Definitions (JF1)	
Pin#	Definition
15	3.3V
16	PWR LED

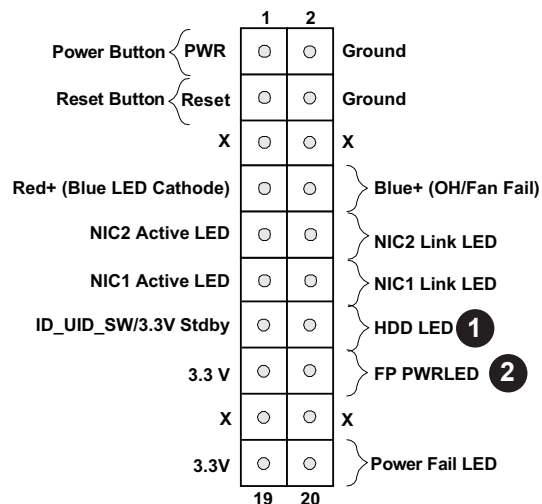

1. HDD/UID
2. PWR LED

### Power Fail LED

The Power Fail LED connection is located on pins 19 and 20 of JF1. Refer to the table below for pin definitions.

Power Fail LED Pin Definitions (JF1)	
Pin#	Definition
19	3.3V
20	PWR Supply Fail

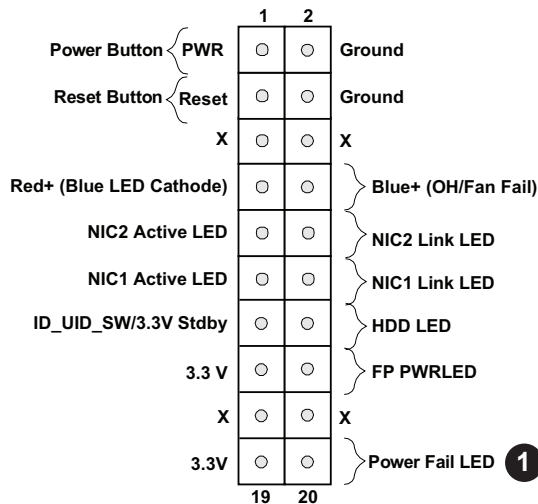

1. PWR Fail LED

## 2.7 Connectors

### Power Connections

#### Main ATX Power Supply Connector

The primary power supply connector (JPWR1) meets the ATX SSI EPS 12V specification. You must also connect the 8-pin (JPWR2) processor power connector to your power supply.

ATX Power 24-pin Connector Pin Definitions			
Pin#	Definition	Pin#	Definition
13	+3.3V	1	+3.3V
14	-12V	2	+3.3V
15	COM	3	COM
16	PS_ON	4	+5V
17	COM	5	COM
18	COM	6	+5V
19	COM	7	COM
20	Res (NC)	8	PWR_OK
21	+5V	9	5VSB
22	+5V	10	+12V
23	+5V	11	+12V
24	COM	12	+3.3V

#### Required Connection

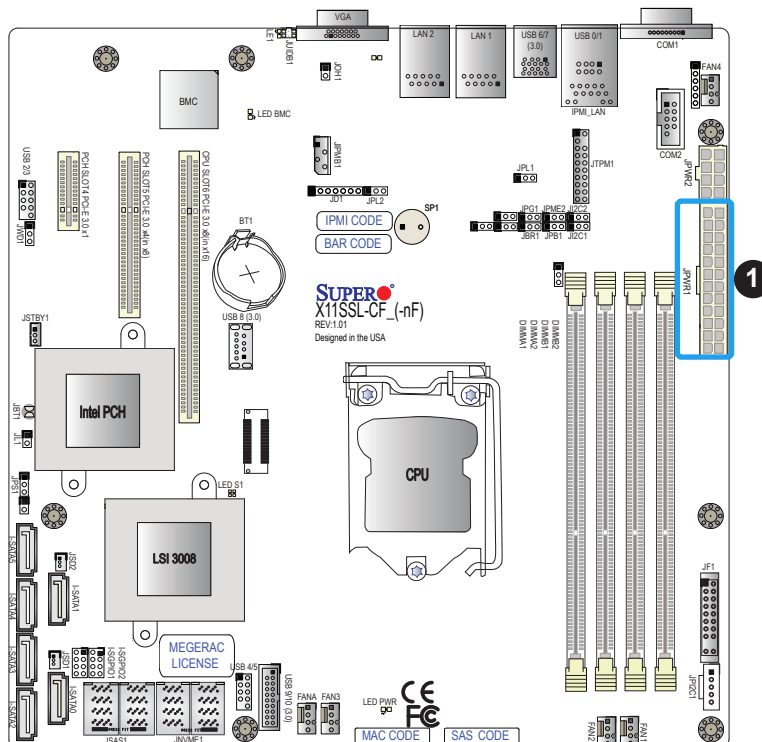

#### 1. 24-Pin ATX Main PWR

### Secondary Power Connector

JPWR2 must also be connected to the power supply. This connector is used to power the processor(s).

+12V 8-pin Power Pin Definitions	
Pin#	Definition
1 - 4	Ground
5 - 8	+12V

#### Required Connection

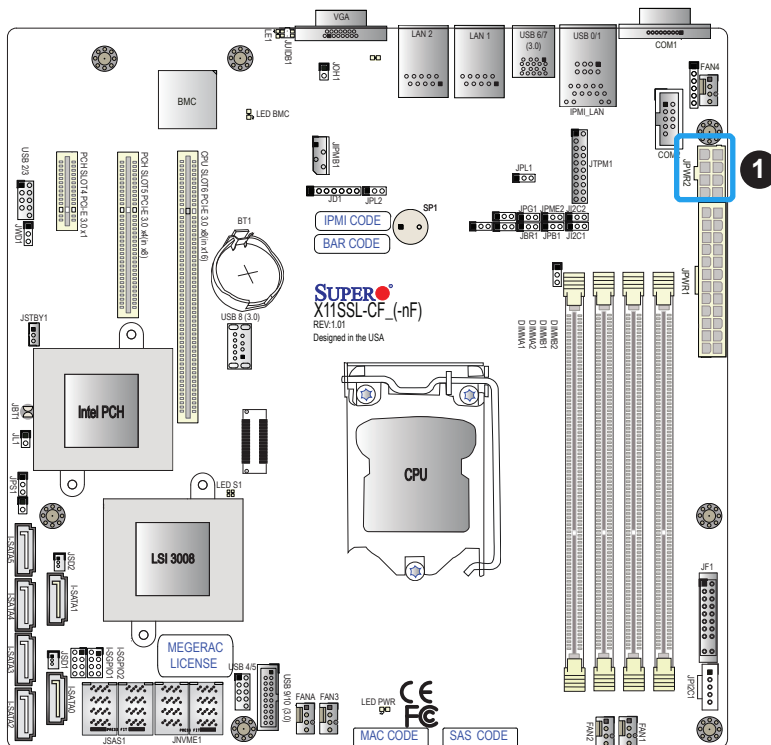

1. 8-Pin PWR

## Headers

### Fan Headers

The X11SSL-CF/-nF has five fan headers (Fan1-Fan4, FanA). All these 4-pin fans headers are backward-compatible with the traditional 3-pin fans. However, fan speed control is available for 4-pin fans only by Thermal Management via the IPMI 2.0 interface. Refer to the table below for pin definitions.

Fan Header Pin Definitions	
Pin#	Definition
1	Ground (Black)
2	+12V (Red)
3	Tachometer
4	PWM Control

### Standby Power

The Wake-On-LAN (WOL) header is located at JSTBY1 on the motherboard. Refer to the table below for pin definitions.

Wake-On-LAN Pin Definitions	
Pin#	Definition
1	+5V Standby
2	Ground
3	Wake-up

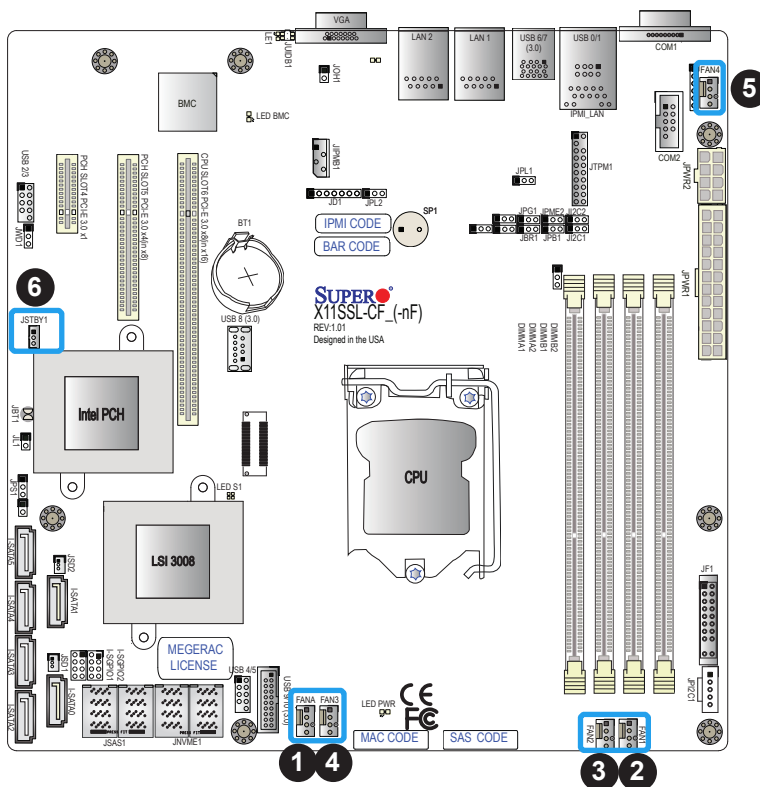

1. FANA
2. FAN1
3. FAN2
4. FAN3
5. FAN4
6. Wake-On-LAN

### Internal Speaker/Buzzer

The Internal Speaker (SP1) can be used to provide audible notifications using various beep codes. Refer to the table below for pin definitions. Refer to the layout below for the location of the internal buzzer.

Internal Buzzer Pin Definitions		
Pin#		Definition
1	Pos (+)	Beep In
2	Neg (-)	Alarm Speaker

### Power LED/Speaker

Pins 1-3 of JD1 are used for power LED indication, and pins 4-7 are for the speaker. Please note that the speaker connector pins (4-7) are used with an external speaker. If you wish to use the onboard speaker, you should close pins 6-7 with a cap. Refer to the tables below for pin definitions.

PWR LED Connector Pin Definitions	
Pin Setting	Definition
1	JD1_PIN1
2	FP_PWR_LED
3	FP_PWR_LED

Speaker Connector Pin Definitions	
Pin Setting	Definition
4	P5V
5	Key
6	R_SPKPIN_N
7	R_SPKPIN

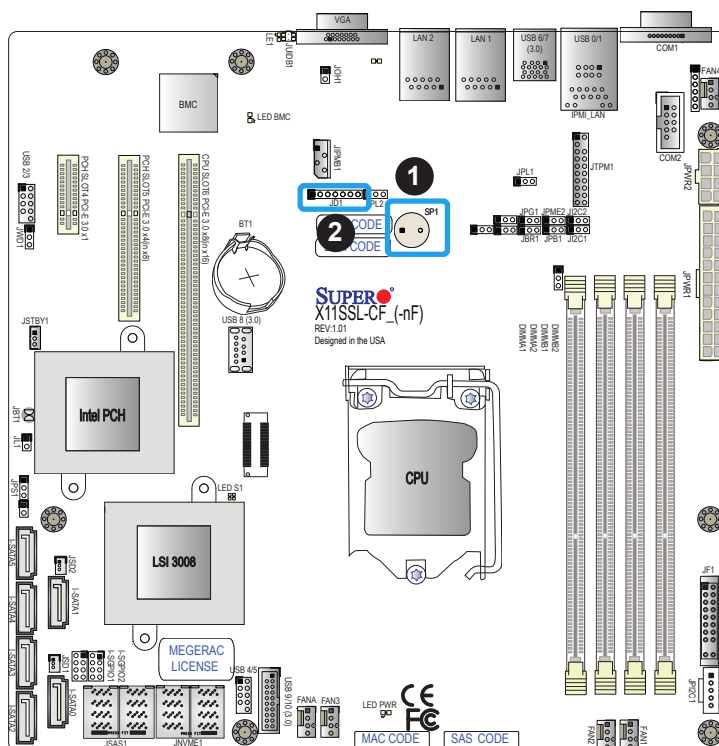

1. Internal Buzzer
2. Speaker Header

## Disk-On-Module Power Connector

Two power connectors for SATA DOM (Disk\_On\_Module) devices are located at JSD1/JSD2. Connect appropriate cables here to provide power support for your Serial Link DOM devices.

DOM Power Pin Definitions	
Pin#	Definition
1	5V
2	Ground
3	Ground

## Chassis Intrusion

A Chassis Intrusion header is located at JL1 on the motherboard. Attach the appropriate cable from the chassis to inform you of a chassis intrusion when the chassis is opened. Refer to the table below for pin definitions.

Chassis Intrusion Pin Definitions	
Pins	Definition
1	Intrusion Input
2	Ground

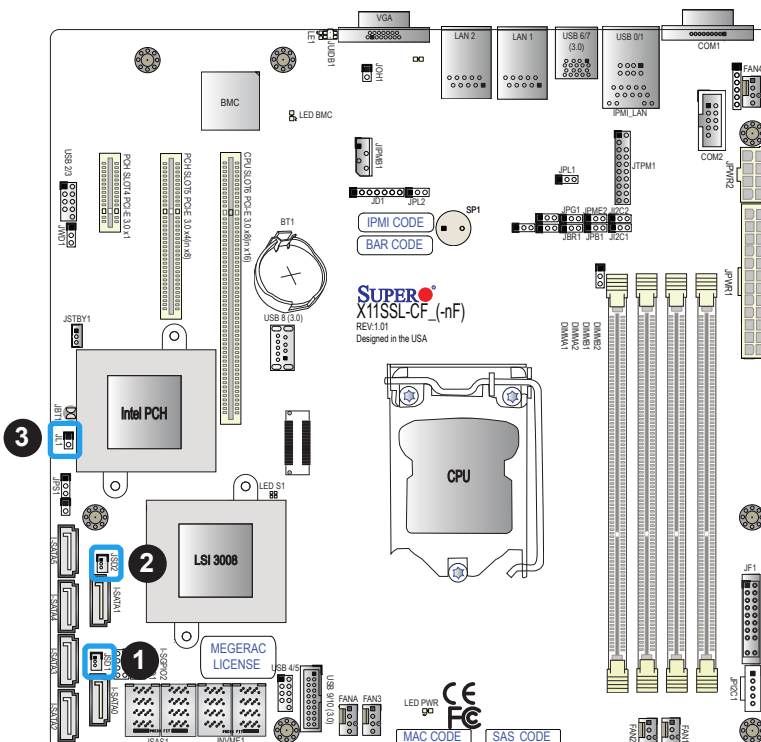

1. DOM PWR1
2. DOM PWR2
3. Chassis Intrusion

### SGPIO Headers

Two I-SGPIO (Serial Link General Purpose Input/Output) headers are located on the motherboard. They support the onboard I-SATA 3.0 ports. Refer to the tables below for pin definitions.

I-SGPIO 1/2	
I-SGPIO1	Ports 2-4
I-SGPIO2	Ports 5-7

SGPIO Header Pin Definitions			
Pin#	Definition	Pin#	Definition
1	NC	2	NC
3	GND	4	Data
5	Load	6	GND
7	Clock	8	NC

NC = No Connection

### Power SMB (I<sup>2</sup>C) Header

The Power System Management Bus (I<sup>2</sup>C) connector (JPI<sup>2</sup>C1) monitors the power supply, fan, and system temperatures. Refer to the table below for pin definitions.

Power SMB Header Pin Definitions	
Pin#	Definition
1	Clock
2	Data
3	PMBUS_Alert
4	Ground
5	+3.3V

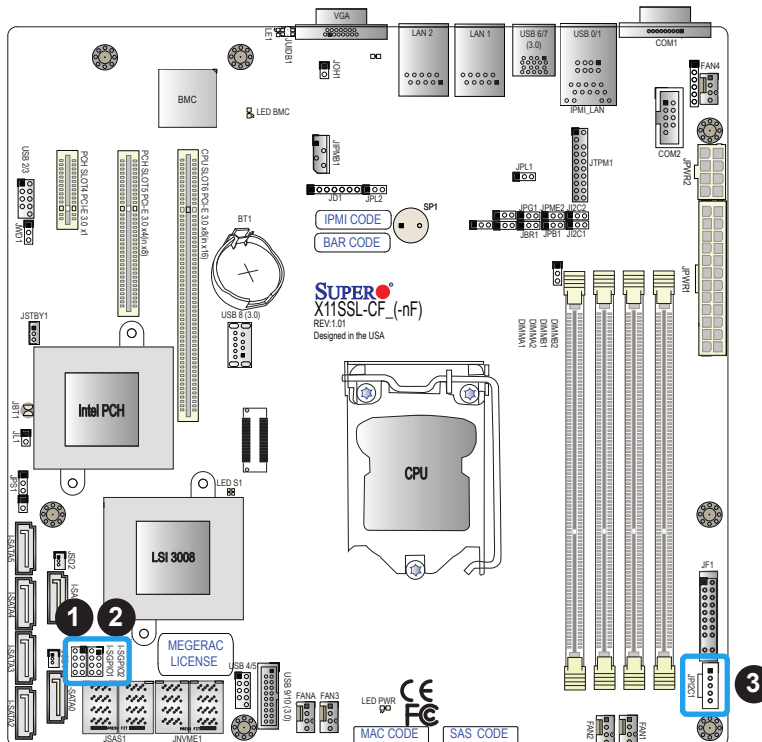

1. I-SGPIO1
2. I-SGPIO2
3. PWR SMB



## TPM/Port 80 Header

A Trusted Platform Module (TPM)/Port 80 header is located at JTPM1 to provide TPM support and Port 80 connection. Use this header to enhance system performance and data security. Refer to the table below for pin definitions.

Trusted Platform Module Header Pin Definitions			
Pin#	Definition	Pin#	Definition
1	LCLK	2	GND
3	LFRAME#	4	<(KEY)>
5	LRESET#	6	+5V
7	LAD3	8	LAD2
9	+3.3V	10	LAD1
11	LAD0	12	GND
13	SMB_CLK	14	SMB_DAT
15	+3V Stdby	16	SERIRQ
17	GND	18	CLKRUN#
19	LPCPD#	20	LDRQ#

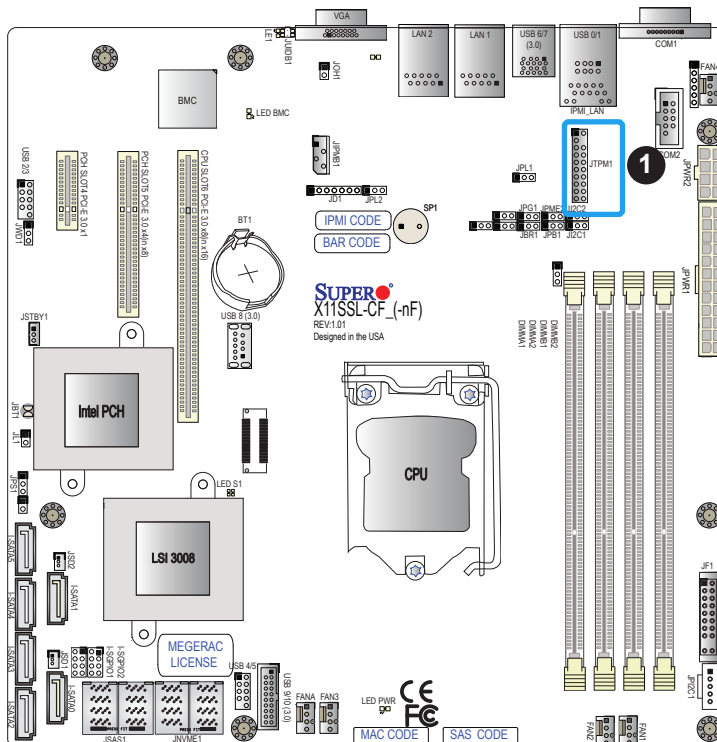

1. JTPM1

### 4-pin BMC External I<sup>2</sup>C Header

A System Management Bus header for IPMI 2.0 is located at JIPMB1. Connect the appropriate cable here to use the IPMB I2C connection on your system. Refer to the table below for pin definitions.

External I <sup>2</sup> C Header Pin Definitions	
Pin#	Definition
1	Data
2	GND
3	Clock
4	NC

### Overheat/Fan Fail LED Header

The JOH1 header is used to connect an LED indicator to provide warnings of chassis overheating and fan failure. This LED will blink when a fan failure occurs. Refer to the tables below for pin definitions.

Overheat LED Header Status	
State	Definition
Solid	Overheat
Blinking	Fan Fail

Overheat LED Pin Definitions	
Pin#	Definition
1	5vDC
2	OH Active

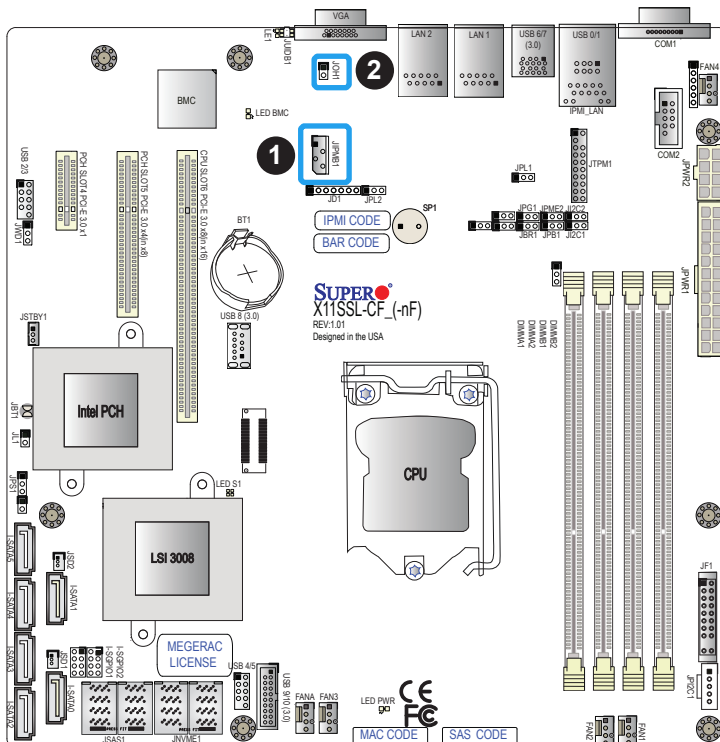

1. IPMB
2. Overheat LED

## SATA Ports

Six SATA 3.0 connectors are located on the X11SSL-CF/-nF motherboard, supported by the Intel C232 PCH chip. These SATA ports support RAID 0, 1, 5, and 10. SATA ports provide serial-link signal connections, which are faster than the connections of Parallel ATA. Refer to the tables below for pin definitions.

**Note 1:** I-SATA0 and I-SATA1 are Supermicro SuperDOMs. These are yellow SATA-DOM connectors with power pins built in and do not require separate external power cables. These connectors are backward-compatible with non-Supermicro SATADOMs that require an external power supply.

**Note 2:** For more information on the SATA HostRAID configuration, please refer to the Intel SATA HostRAID user's guide posted on our website at <http://www.supermicro.com>.

X11SSL-CF/-nF SATA 3.0 Connector Types	
Port #	Connection Type
I-SATA0-1 (Two)	SATA 3.0/6 Gb/s RAID 0, 1, 5, 10 SuperDOM connectors
I-SATA2-5 (Four)	SATA 3.0/6 Gb/s RAID 0, 1, 5, 10
Supported by	Intel C232 PCH-Exp.

SATA 3.0 Port Pin Definitions	
Pin#	Signal
1	Ground
2	SATA_TXP
3	SATA_TXN
4	Ground
5	SATA_RXN
6	SATA_RXP
7	Ground

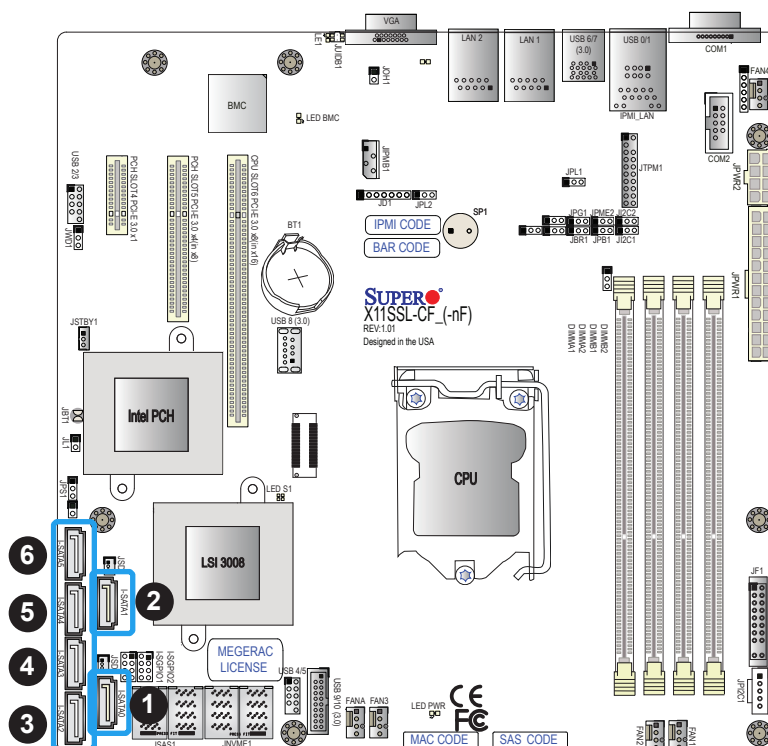

1. I-SATA0
2. I-SATA1
3. I-SATA2
4. I-SATA3
5. I-SATA4
6. I-SATA5

### Mini-SAS HD Connections (X11SSL-CF only)

Two mini-SAS HD ports are located at JSAS1 on the X11SSL-CF motherboard. These ports support 8x SAS 12Gb/s and allow for the connection of smaller drives than regular SAS connectors.

### NVM Express Connections (X11SSL-nF only)

Two NVM Express ports are located at JNVME1 on the X11SSL-nF motherboard. These NVM ports provide PCI Express 3.0 connections and provide high-speed low-latency connections directly from the CPU to NVMe Solid State Drives (SSD). This greatly increases SSD data throughput performance and significantly reduces PCI-E latency by simplifying driver/software requirements.

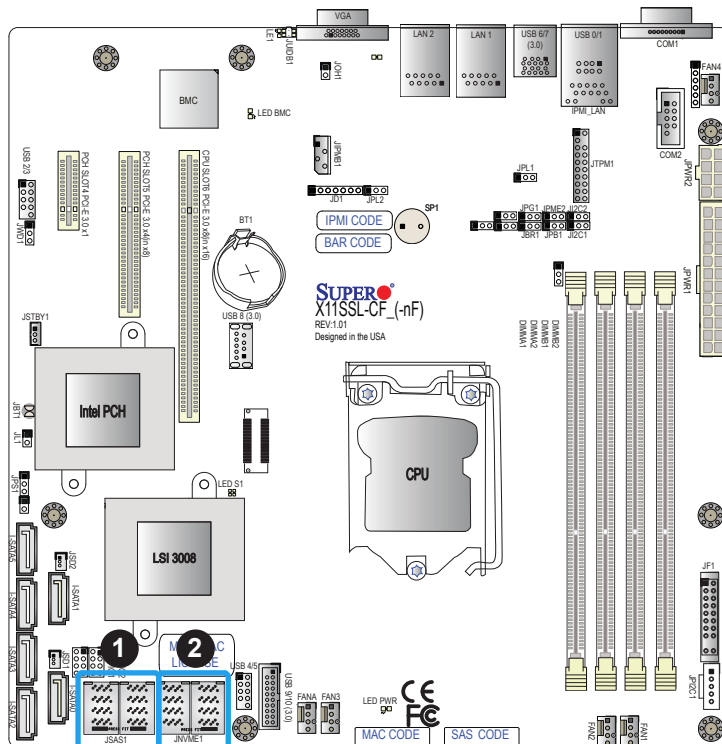

1. Mini-SAS HD (X11SSL-CF only)
2. NVMe (X11SSL-nF only)

## Unit Identifier Switch/UID LED Indicator

A rear Unit Identifier (UID) switch and a rear UID LED (LE1) are located next to the VGA port on the motherboard. The front UID switch and the front UID LED are both located on the Front Panel Control (JF1) (with the front UID switch on pin 13, and the front LED on pin 7 of JF1). When you press the front or the rear UID switch, both front and rear UID LEDs will be turned on. Press the UID switch again to turn off the LED indicators. The UID Indicators provide easy identification of a system unit that may be in need of service.

 **Note:** UID can also be triggered via IPMI on the motherboard. For more information on IPMI, please refer to the IPMI User's Guide posted on our website at <http://www.supermicro.com>.

UID Switch Pin Definitions	
Pin#	Definition
1	Ground
2	Ground
3	Button In
4	Ground

UID LED Pin Definitions	
Color	Status
Blue	On
	Unit Identified

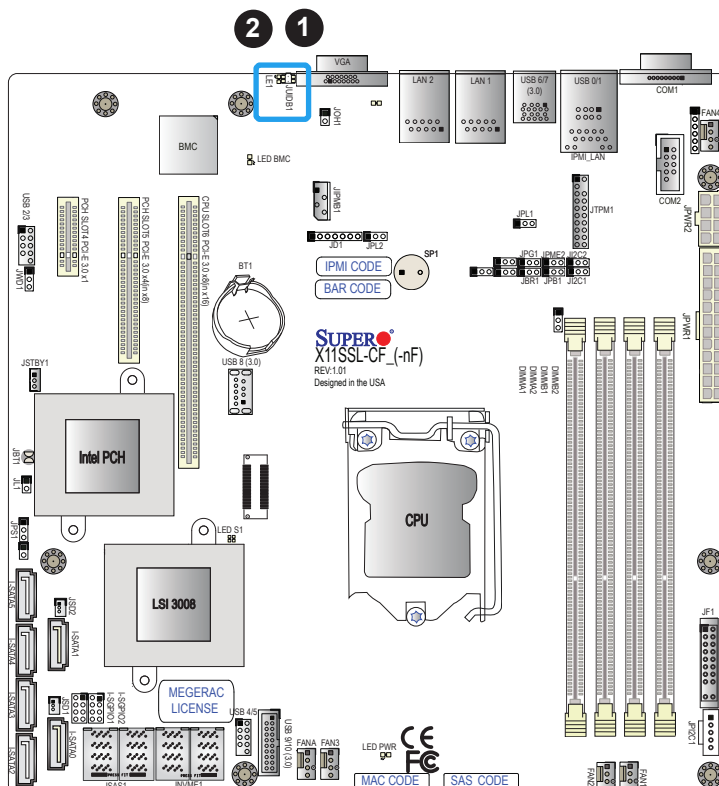

1. UID Switch
2. UID LED

## 2.8 Jumper Settings

### How Jumpers Work

To modify the operation of the motherboard, jumpers can be used to choose between optional settings. Jumpers create shorts between two pins to change the function of the connector. Pin 1 is identified with a square solder pad on the printed circuit board. See the diagram below for an example of jumping pins 1 and 2. Refer to the motherboard layout page for jumper locations.

 **Note:** On two-pin jumpers, "Closed" means the jumper is on and "Open" means the jumper is off the pins.

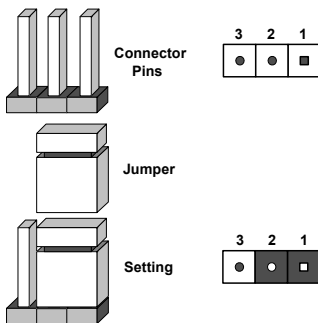

## LAN Port Enable/Disable

Change the setting of jumper JPL1/JPL2 to enable or disable the LAN1/LAN2 LAN ports, respectively. The default setting is Enabled.

LAN1/2 Enable/Disable Jumper Settings	
Jumper Setting	Definition
Pins 1-2	Enabled
Pins 2-3	Disabled

## CMOS Clear

JBT1 is used to clear the CMOS. Instead of pins, this "jumper" consists of contact pads to prevent accidental clearing of the CMOS. To clear the CMOS, use a metal object such as a small screwdriver to touch both pads at the same time to short the connection.

 **Note:** Be sure to completely shut down the system, and then short JBT1 to clear the CMOS.

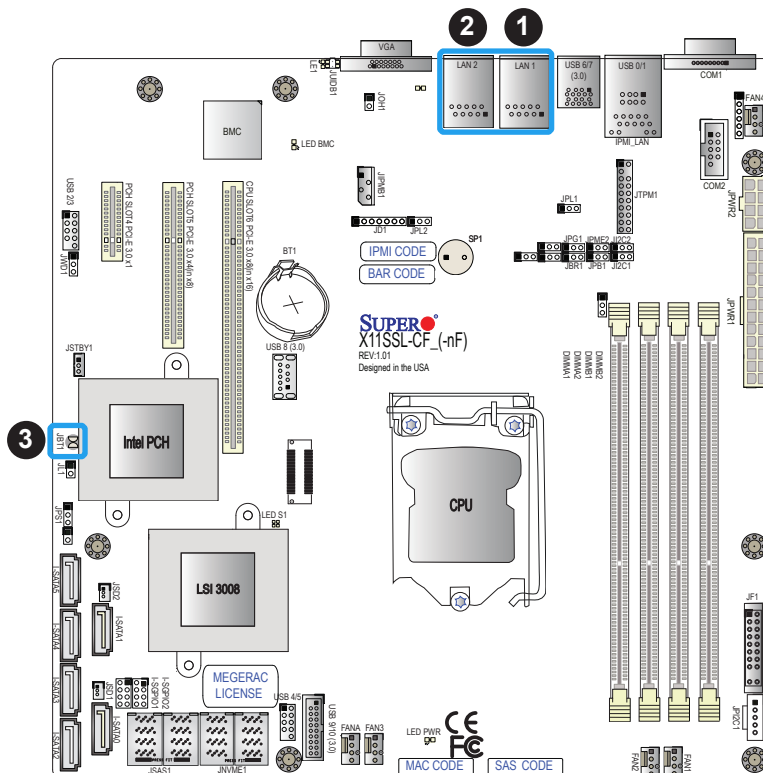

1. LAN1
2. LAN2
3. CMOS Clear

### Watch Dog

Watch Dog (JWD1) is a system monitor that can reboot the system when a software application hangs. Close pins 1-2 to reset the system if an application hangs. Close pins 2-3 to generate a non-maskable interrupt (NMI) signal for the application that hangs. Refer to the table below for jumper settings. The Watch Dog must also be enabled in the BIOS.

Watch Dog Jumper Settings	
Jumper Setting	Definition
Pins 1-2	Reset
Pins 2-3	NMI
Open	Disabled

### SMBus to PCI Slots

Use jumpers JI<sup>2</sup>C1 and JI<sup>2</sup>C2 to connect the System Management Bus (I<sup>2</sup>C) to PCI-Express slots to improve PCI performance. These two jumpers should be set at the same time. Refer to the table below for jumper settings. The default setting is Disabled.

I <sup>2</sup> C for PCI-E Slots Jumper Settings	
Jumper Setting	Definition
Pins 1-2	Enabled
Pins 2-3	Disabled

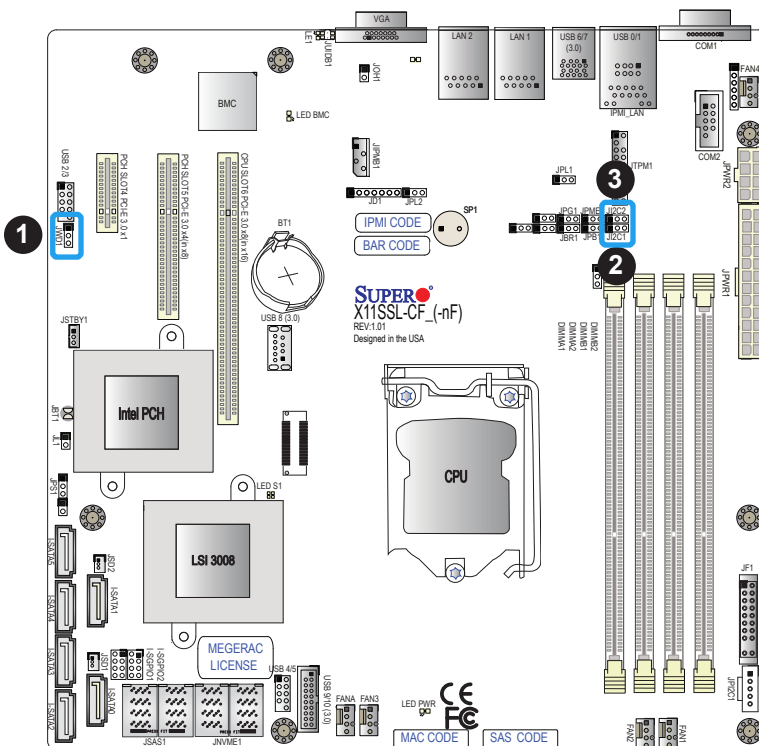

1. Watch Dog
2. JI<sup>2</sup>C1
3. JI<sup>2</sup>C2



## VGA Enable/Disable

Jumper JPG1 allows the user to enable the onboard VGA connector. The default setting is pins 1-2 to enable the connection. Refer to the table below for jumper settings. The default setting is Enabled.

VGA Enable/Disable Jumper Settings	
Jumper Setting	Definition
Pins 1-2	Enabled
Pins 2-3	Disabled

## BIOS Recovery

Use jumper JBR1 to recover the BIOS settings on the motherboard. Refer to the table below for jumper settings. The default setting is Normal.

BIOS Recovery Jumper Settings	
Jumper Setting	Definition
Pins 1-2	Normal
Pins 2-3	BIOS Recovery

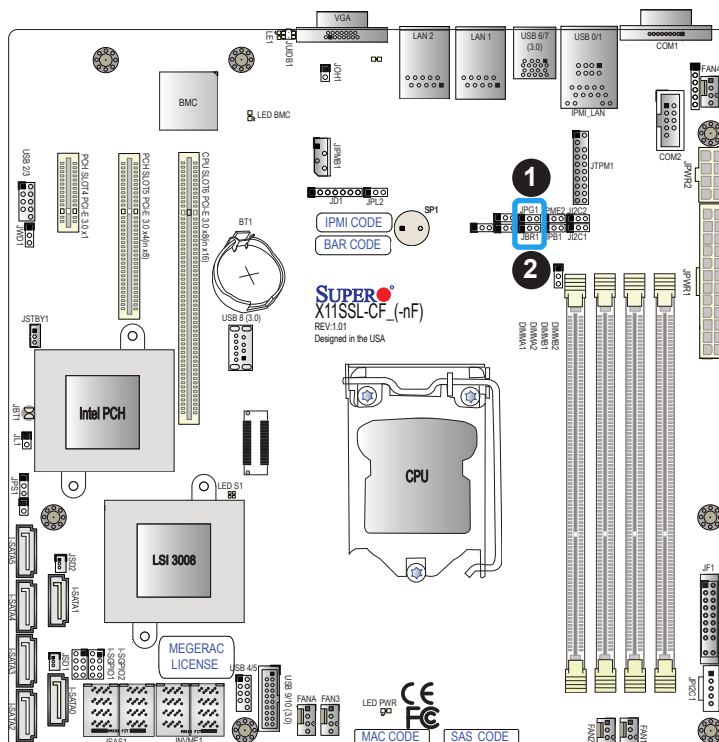

1. VGA Enable
2. BIOS Recovery Enable

### Manufacturer Mode Select

Close pin 2 and pin 3 of jumper JPME2 to bypass SPI flash security and force the system to operate in the manufacturer mode, which will allow the user to flash the system firmware from a host server for system setting modifications. Refer to the table below for jumper settings. The default setting is Normal.

Manufacturer Mode Jumper Settings	
Jumper Setting	Definition
Pins 1-2	Normal
Pins 2-3	Manufacturer Mode

### SAS Status (For -CF models only)

JPS1 allows the user to enable the SAS status indicator at LEDS1. The default setting is Enabled. See the table below for jumper settings.

SAS Status Jumper Settings	
Jumper Setting	Definition
Pins 1-2	Enabled
Pins 2-3	Disabled

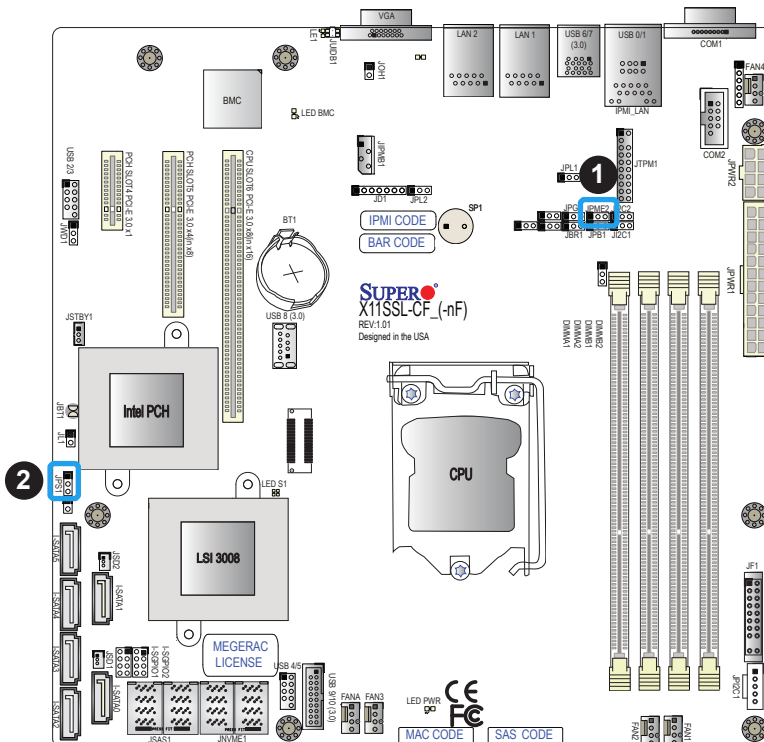

1. Manufacturer Mode Select
2. SAS Status

## BMC Enable

Jumper JPB1 allows the user to enable the embedded BMC (Baseboard Management) Controller to provide IPMI 2.0/KVM support. The default setting is BMC Enable. Refer to the table below for jumper settings.

BMC Enable Jumper Settings	
Jumper Setting	Definition
Pins 1-2	BMC Enabled
Pins 2-3	Disabled

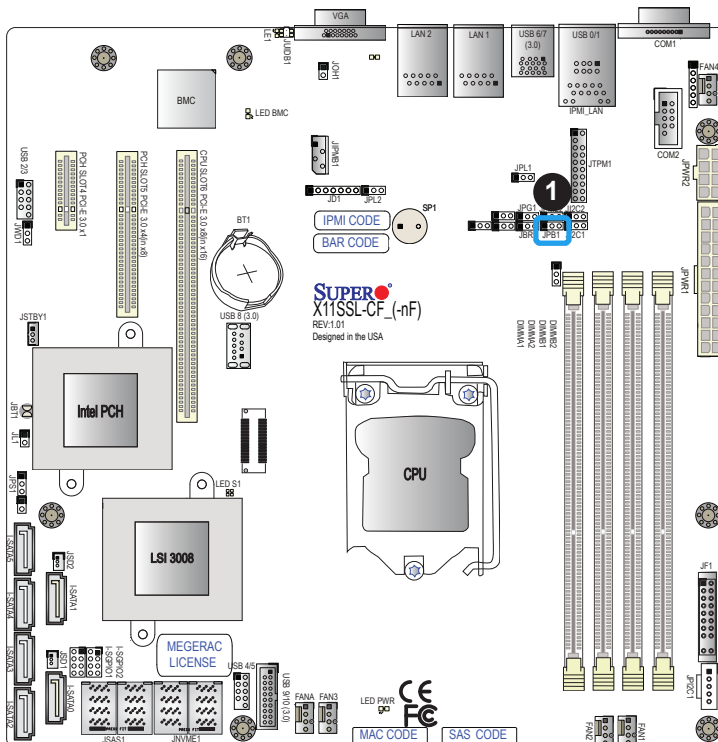

### 1. BMC Enable

## 2.9 LED Indicators

### LAN LEDs

Two LAN ports (LAN 1 and LAN 2) are located on the I/O back panel of the motherboard. Each Ethernet LAN port has two LEDs. The green LED indicates activity, while the other Link LED may be green, amber, or off to indicate the speed of the connection. Refer to the tables below for more information.

LAN1/2 Activity LED (Right) LED State		
Color	Status	Definition
Green	Flashing	Active

LAN1/2 Link LED (Left) LED State	
LED Color	Definition
Off	No Connection/10 Mbps
Amber	1 Gbps
Green	100 Mbps

### Dedicated IPMI LAN LEDs

In addition to LAN 1 and LAN 2, an IPMI LAN is also located on the I/O back panel. The amber LED on the right indicates activity, while the green LED on the left indicates the speed of the connection. Refer to the table below for more information.

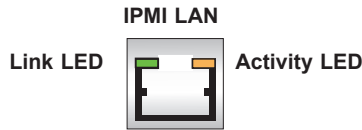

IPMI LAN LEDs		
	Color/State	Definition
Link (left)	Green: Solid Amber: Solid	100 Mbps 1Gbps
Activity (Right)	Amber: Blinking	Active

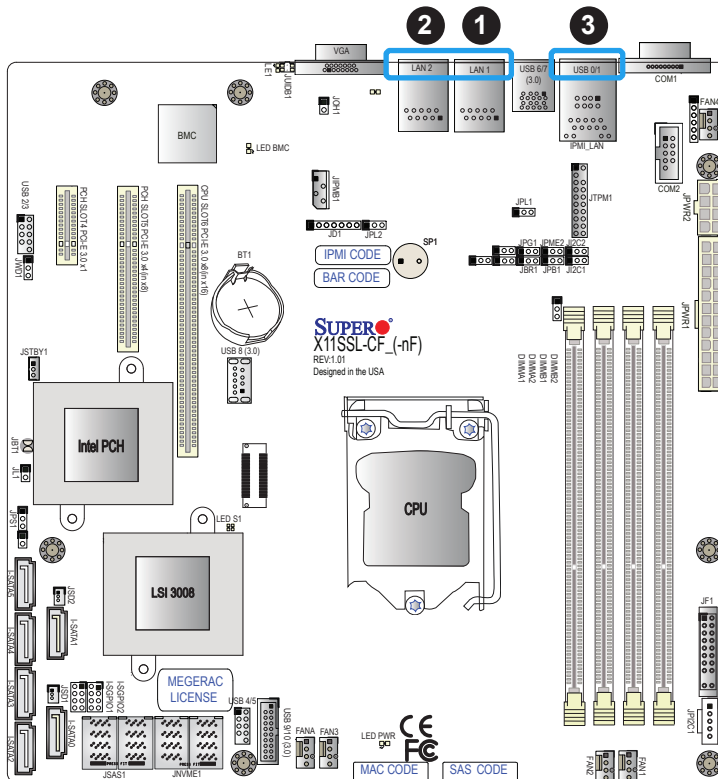

- 1. LAN1 LEDs
- 2. LAN2 LEDs
- 3. IPMI-Dedicated LAN LEDs

## Onboard Power LED

The Onboard Power LED is located at LEDPWR on the motherboard. When this LED is on, the system is on. Be sure to turn off the system and unplug the power cord before removing or installing components. Refer to the table below for more information.

Onboard Power LED Indicator	
LED Color	Definition
Off	System Off (power cable not connected)
Green	System On

## BMC Heartbeat LED

A BMC Heartbeat LED is located at LEDBMC on the motherboard. When LEDBMC is blinking, the BMC is functioning normally. Refer to the table below for more information.

Onboard Power LED Indicator	
LED Color	Definition
Green:	BMC: Normal
Blinking	

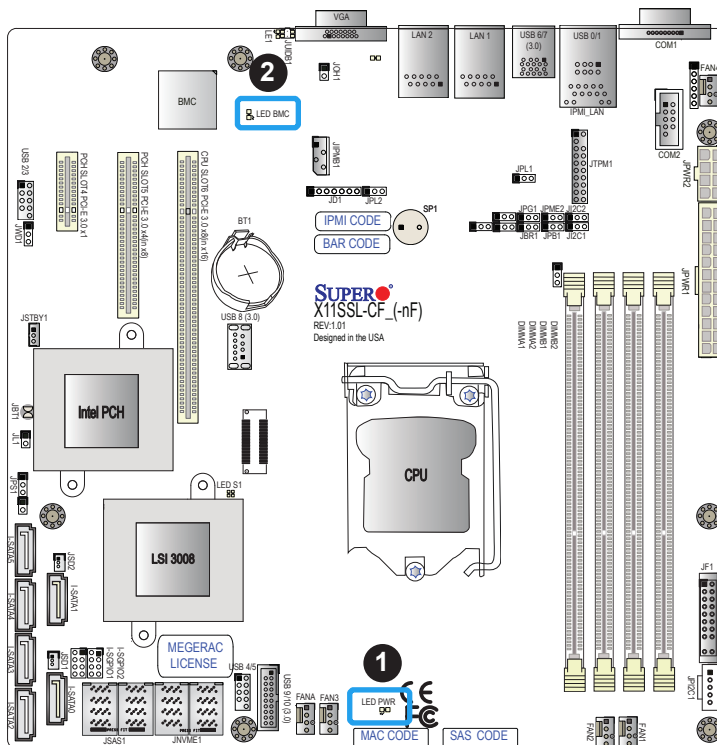

1. Onboard Power LED
2. BMC Heartbeat LED

### SAS Heartbeat LED (For -CF models only)

A SAS heartbeat LED is located at LEDS1. When LEDS1 flashes, it indicates SAS is functioning normally.

SAS Heartbeat LED Indicator	
LED Color	Definition
Green:	SAS Normal
Blinking	
Red: Solid On	SAS Error

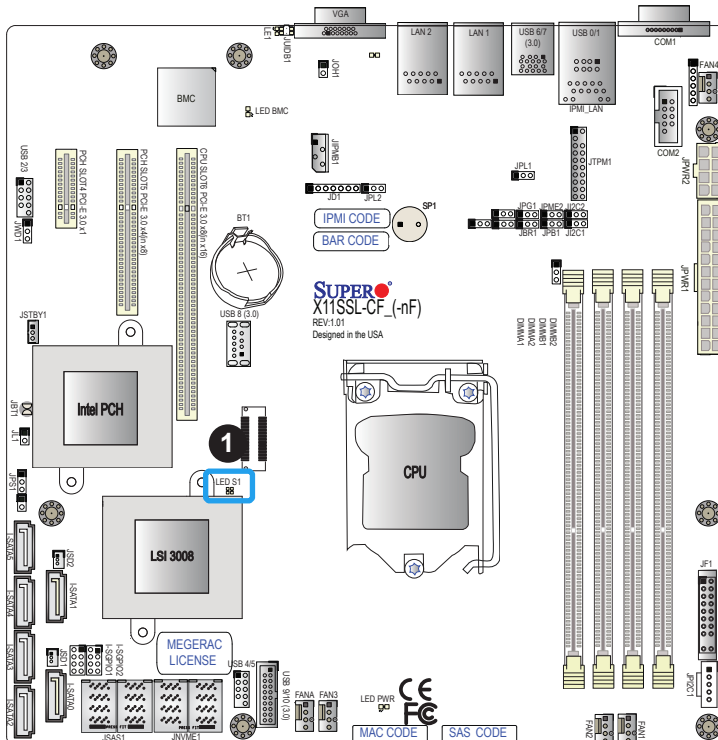

### 1. SAS Heartbeat LED

# Chapter 3

## Troubleshooting

### 3.1 Troubleshooting Procedures

Use the following procedures to troubleshoot your system. If you have followed all of the procedures below and still need assistance, refer to the 'Technical Support Procedures' and/or 'Returning Merchandise for Service' section(s) in this chapter. Always disconnect the AC power cord before adding, changing or installing any non hot-swap hardware components.

#### **Before Power On**

1. Make sure that there are no short circuits between the motherboard and chassis.
2. Disconnect all ribbon/wire cables from the motherboard, including those for the keyboard and mouse.
3. Remove all add-on cards.
4. Install the CPU first (making sure it is fully seated) and connect the front panel connectors to the motherboard.

#### **No Power**

1. Make sure that there are no short circuits between the motherboard and the chassis.
2. Make sure that the ATX power connectors are properly connected.
3. Check that the 115V/230V switch, if available, on the power supply is properly set.
4. Turn the power switch on and off to test the system, if applicable.
5. The battery on your motherboard may be old. Check to verify that it still supplies ~3VDC. If it does not, replace it with a new one.

#### **No Video**

1. If the power is on but you have no video, remove all the add-on cards and cables.
2. Use the speaker to determine if any beep codes exist. Refer to Appendix A for details on beep codes.

3. Remove all memory modules and turn on the system (if the alarm is on, check the specs of memory modules, reset the memory or try a different one).

## System Boot Failure

If the system does not display POST (Power-On-Self-Test) or does not respond after the power is turned on, check the following:

1. Check for any error beep from the motherboard speaker.
  - If there is no error beep, try to turn on the system without DIMM modules installed. If there is still no error beep, replace the motherboard.
  - If there are error beeps, clear the CMOS settings by unplugging the power cord and contacting both pads on the CMOS Clear Jumper (JBT1). Refer to Section 2-8 in Chapter 2.
2. Remove all components from the motherboard, especially the DIMM modules. Make sure that system power is on and that memory error beeps are activated.
3. Turn on the system with only one DIMM module installed. If the system boots, check for bad DIMM modules or slots by following the Memory Errors Troubleshooting procedure in this Chapter.

## Memory Errors

When a no-memory beep code is issued by the system, check the following:

1. Make sure that the memory modules are compatible with the system and that the DIMMs are properly and fully installed. (For memory compatibility, refer to the memory compatibility chart posted on our website at <http://www.supermicro.com>.)
2. Check if different speeds of DIMMs have been installed. It is strongly recommended that you use the same RAM type and speed for all DIMMs in the system.
3. Make sure that you are using the correct type of UDIMM ECC DDR4 modules recommended by the manufacturer.
4. Check for bad DIMM modules or slots by swapping a single module among all memory slots and check the results.
5. Make sure that all memory modules are fully seated in their slots. Follow the instructions given in Chapter 2.
6. Please follow the instructions given in the DIMM population tables listed in Section 2-4 to install your memory modules.



## Losing the System's Setup Configuration

1. Make sure that you are using a high-quality power supply. A poor-quality power supply may cause the system to lose the CMOS setup information. Refer to Chapter 2 for details on recommended power supplies.
2. The battery on your motherboard may be old. Check to verify that it still supplies ~3VDC. If it does not, replace it with a new one.
3. If the above steps do not fix the setup configuration problem, contact your vendor for repairs.

## When the System Becomes Unstable

### ***A. If the system becomes unstable during or after OS installation, check the following:***

1. CPU/BIOS support: Make sure that your CPU is supported and that you have the latest BIOS installed in your system.
2. Memory support: Make sure that the memory modules are supported by testing the modules using memtest86 or a similar utility.



**Note:** Refer to the product page on our website at <http://www.supermicro.com> for memory and CPU support and updates.

3. HDD support: Make sure that all hard disk drives (HDDs) work properly. Replace the bad HDDs with good ones.
4. System cooling: Check the system cooling to make sure that all heatsink fans and CPU/system fans, etc., work properly. Check the hardware monitoring settings in the IPMI to make sure that the CPU and system temperatures are within the normal range. Also check the front panel Overheat LED and make sure that it is not on.
5. Adequate power supply: Make sure that the power supply provides adequate power to the system. Make sure that all power connectors are connected. Please refer to our website for more information on the minimum power requirements.
6. Proper software support: Make sure that the correct drivers are used.

### ***B. If the system becomes unstable before or during OS installation, check the following:***

1. Source of installation: Make sure that the devices used for installation are working properly, including boot devices such as CD/DVD and CD/DVD-ROM.
2. Cable connection: Check to make sure that all cables are connected and working properly.

3. Using the minimum configuration for troubleshooting: Remove all unnecessary components (starting with add-on cards first), and use the minimum configuration (but with the CPU and a memory module installed) to identify the trouble areas. Refer to the steps listed in Section A above for proper troubleshooting procedures.
4. Identifying bad components by isolating them: If necessary, remove a component in question from the chassis, and test it in isolation to make sure that it works properly. Replace a bad component with a good one.
5. Check and change one component at a time instead of changing several items at the same time. This will help isolate and identify the problem.
6. To find out if a component is good, swap this component with a new one to see if the system will work properly. If so, then the old component is bad. You can also install the component in question in another system. If the new system works, the component is good and the old system has problems.

## 3.2 Technical Support Procedures

Before contacting Technical Support, please take the following steps. Also, please note that as a motherboard manufacturer, Supermicro also sells motherboards through its channels, so it is best to first check with your distributor or reseller for troubleshooting services. They should know of any possible problems with the specific system configuration that was sold to you.

1. Please go through the Troubleshooting Procedures and Frequently Asked Questions (FAQ) sections in this chapter or see the FAQs on our website (<http://www.supermicro.com/>) before contacting Technical Support.
2. BIOS upgrades can be downloaded from our website (<http://www.supermicro.com>).
3. If you still cannot resolve the problem, include the following information when contacting Supermicro for technical support:
  - Motherboard model and PCB revision number
  - BIOS release date/version (This can be seen on the initial display when your system first boots up.)
  - System configuration
4. An example of a Technical Support form is on our website at <http://www.supermicro.com/RmaForm/>.
  - Distributors: For immediate assistance, please have your account number ready when placing a call to our Technical Support department. We can be reached by email at [support@supermicro.com](mailto:support@supermicro.com).

## 3.3 Frequently Asked Questions

**Question: What type of memory does my motherboard support?**

**Answer:** The motherboard supports ECC DDR4 UDIMM modules. To enhance memory performance, do not mix memory modules of different speeds and sizes. Please follow all memory installation instructions given in Section 2-4 in Chapter 2.

**Question: How do I update my BIOS?**

**Answer:** It is recommended that you do not upgrade your BIOS if you are not experiencing any problems with your system. Updated BIOS files are located on our website at <http://www.supermicro.com>. Please check our BIOS warning message and the information on how to update your BIOS on our website. Select your motherboard model and download the BIOS file to your computer. Also, check the current BIOS revision to make sure that it is newer than your BIOS before downloading. You can choose from the zip file and the .exe file. If you choose the zip BIOS file, please unzip the BIOS file onto a bootable USB device. Run the batch file using the format FLASH.BAT filename.rom from your bootable USB device to flash the BIOS. Then, your system will automatically reboot.

**Warning:** Do not shut down or reset the system while updating the BIOS to prevent possible system boot failure!)



**Note:** The SPI BIOS chip used on this motherboard cannot be removed. Send your motherboard back to our RMA Department at Supermicro for repair. For BIOS Recovery instructions, please refer to the AMI BIOS Recovery Instructions posted at <http://www.supermicro.com>.

## 3.4 Battery Removal and Installation

### Battery Removal

To remove the onboard battery, follow the steps below:

1. Power off your system and unplug your power cable.
2. Locate the onboard battery as shown below.
3. Using a tool such as a pen or a small screwdriver, push the battery lock outwards to unlock it. Once unlocked, the battery will pop out from the holder.
4. Remove the battery.

### Proper Battery Disposal

Please handle used batteries carefully. Do not damage the battery in any way; a damaged battery may release hazardous materials into the environment. Do not discard a used battery in the garbage or a public landfill. Please comply with the regulations set up by your local hazardous waste management agency to dispose of your used battery properly.

### Battery Installation

1. To install an onboard battery, follow the steps 1 & 2 above and continue below:
2. Identify the battery's polarity. The positive (+) side should be facing up.
3. Insert the battery into the battery holder and push it down until you hear a click to ensure that the battery is securely locked.



**Important:** When replacing a battery, be sure to only replace it with the same type.

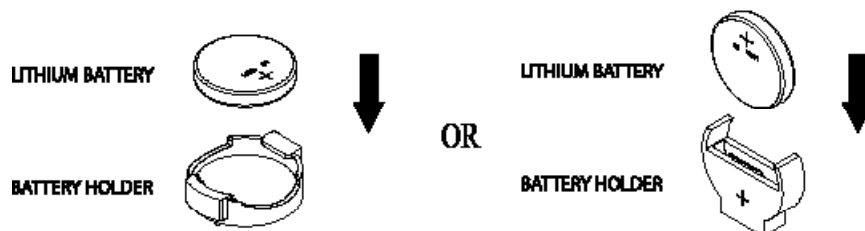

### **3.5 Returning Merchandise for Service**

A receipt or copy of your invoice marked with the date of purchase is required before any warranty service will be rendered. You can obtain service by calling your vendor for a Returned Merchandise Authorization (RMA) number. When returning the motherboard to the manufacturer, the RMA number should be prominently displayed on the outside of the shipping carton, and the shipping package is mailed prepaid or hand-carried. Shipping and handling charges will be applied for all orders that must be mailed when service is complete. For faster service, You can also request a RMA authorization online (<http://www.supermicro.com/RmaForm/>).

This warranty only covers normal consumer use and does not cover damages incurred in shipping or from failure due to the alternation, misuse, abuse or improper maintenance of products.

During the warranty period, contact your distributor first for any product problems.

---

# Chapter 4

## BIOS

### 4.1 Introduction

This chapter describes the AMIBIOS™ setup utility for the X11SSL-CF/X11SSL-nF motherboard. The BIOS is stored on a Flash EEPROM and can be easily upgraded using a flash program.



**Note:** Due to periodic changes to the BIOS, some settings may have been added or deleted and might not yet be recorded in this manual. Please refer to the Manual Download area of our website for any changes to BIOS that may not be reflected in this manual.

#### Starting the Setup Utility

To enter the BIOS setup utility, enter the <Delete> key while the system is booting up. (In most cases, the <Delete> key is used to invoke the BIOS setup screen. There are a few cases when other keys are used, such as <F1>, <F2>, etc.) Each main BIOS menu option is described in this manual.

The main BIOS screen has two main frames. The left frame displays all the options that can be configured. “Grayed-out” options cannot be configured. The right frame displays the key legend. Above the key legend is an area reserved for a text message. When an option is selected in the left frame, it is highlighted in white. Often a text message will accompany it. Note that BIOS has default text messages built in. We retain the option to include, omit, or change any of these text messages. Settings printed in **Bold** are the default values.

A "►" indicates a submenu. Highlighting such an item and pressing the <Enter> key will open the list of settings within the submenu.

The BIOS setup utility uses a key-based navigation system called hot keys. Most of these hot keys (<F1>, <F4>, <Enter>, <ESC>, <Arrow> keys, etc.) can be used at any time during the setup navigation process.



**Note 1:** Options printed in **Bold** are default settings.

**Note 2:** <F3> is used to load optimal default settings. <F4> is used to save the settings and exit the BIOS setup utility.

## How To Change the Configuration Data

The configuration data that determines the system parameters may be changed by entering the AMI BIOS setup utility. This setup utility can be accessed by pressing <Delete> at the appropriate time during system boot.

 **Note:** For AMI UEFI BIOS Recovery, please refer to the UEFI BIOS Recovery User Guide posted at <http://www.supermicro.com/support/manuals/>.

## 4.2 Main Setup

When you first enter the AMI BIOS setup utility, you will enter the Main setup screen. You can always return to the Main setup screen by selecting the Main tab on the top of the screen. The Main BIOS setup screen is shown below. The following Main menu items will display:

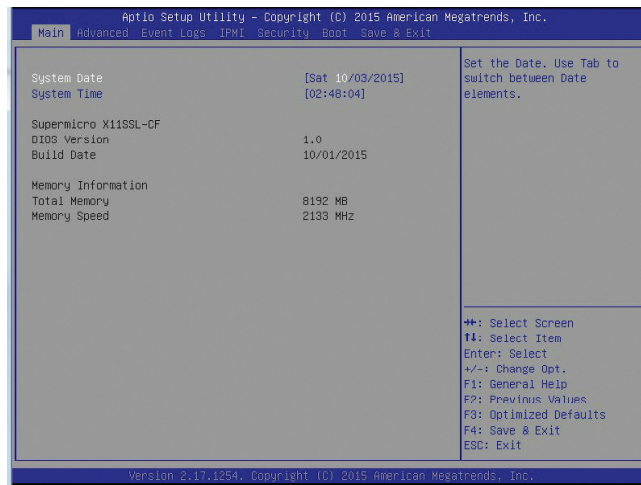



### **System Date/System Time**

Use this option to change the system date and time. Highlight *System Date* or *System Time* using the arrow keys. Enter new values using the keyboard. Press the <Tab> key or the arrow keys to move between fields. The date must be entered in Day MM/DD/YYYY format. The time is entered in HH:MM:SS format.



**Note:** The time is in the 24-hour format. For example, 5:30 P.M. appears as 17:30:00. The default value for System Date is 01/01/2015 after RTC (Real Time Clock) reset.

### **Supermicro X11SSL-CF**

#### **BIOS Version**

This feature displays the version of the BIOS ROM used in the system.

#### **Build Date**

This feature displays the date when the version of the BIOS ROM used in the system was built.

#### **Memory Information**

##### **Total Memory**

This feature displays the total size of memory available in the system.

##### **Memory Speed**

This feature displays the speed of memory modules used in the system.

## 4.3 Advanced Setup Configurations

Use the arrow keys to select Boot Setup and press <Enter> to access the submenu items.

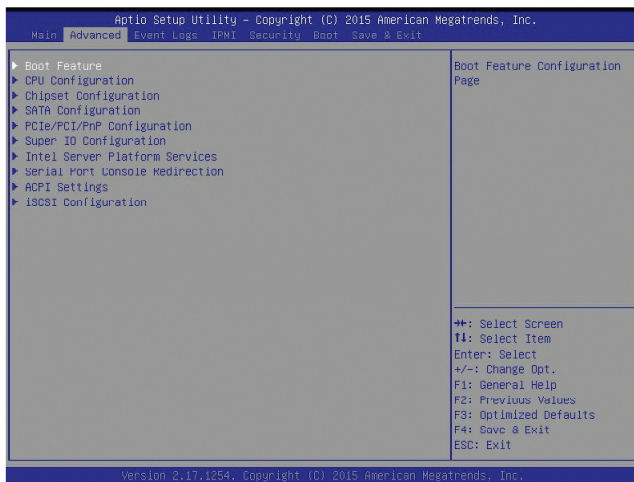

**Warning:** Take caution when changing the Advanced settings. An incorrect value, an inaccurate DRAM frequency, or a wrong DRAM timing setting may make the system unstable. When this occurs, revert the setting to the manufacture default settings.

### ► Boot Feature

#### Quiet Boot

Use this feature to select the screen display between the POST messages and the OEM logo upon bootup. Select Disabled to display the POST messages. Select Enabled to display the OEM logo instead of the normal POST messages. The options are **Enabled** and Disabled.

#### AddOn ROM Display Mode

Use this feature to set the display mode for the Option ROM. Select Keep Current to display the current AddOn ROM setting. Select Force BIOS to use the Option ROM display set by the system BIOS. The options are **Force BIOS** and Keep Current.

#### Bootup NumLock State

Use this feature to set the Power-on state for the <Numlock> key. The options are Off and **On**.

#### Wait For "F1" If Error

Use this feature to force the system to wait until the <F1> key is pressed if an error occurs. The options are Disabled and **Enabled**.

#### INT19 (Interrupt 19) Trap Response

Interrupt 19 is the software interrupt that handles the boot disk function. When this item is set to Immediate, the ROM BIOS of the host adaptors will "capture" Interrupt 19 at bootup immediately and allow the drives that are attached to these host adaptors to function as

bootable disks. If this item is set to Postponed, the ROM BIOS of the host adaptors will not capture Interrupt 19 immediately and allow the drives attached to these adaptors to function as bootable devices at bootup. The options are **Immediate** and Postponed.

### **Re-try Boot**

If this feature is enabled, the BIOS will automatically reboot the system from a specified boot device after its initial boot failure. The options are **Disabled**, Legacy Boot, and EFI Boot.

## **►Power Configuration**

### **Watch Dog Function**

If enabled, the Watch Dog timer will allow the system to reset or generate NMI signals based on the Watch Dog jumper setting when the system is inactive more than 5 minutes. The options are **Disabled** and Enabled.

### **Power Button Function**

This feature controls how the system shuts down when the power button is pressed. Select 4\_Seconds\_Override for the user to power off the system after pressing and holding the power button for 4 seconds or longer. Select Instant Off to instantly power off the system as soon as the user presses the power button. The options are **Instant Off** and 4 Seconds Override.

### **Restore on AC Power Loss**

Use this feature to set the power state after a power outage. Select Stay-Off for the system power to remain off after a power loss. Select Power-On for the system power to be turned on after a power loss. Select Last State to allow the system to resume its last power state before a power loss. The options are Stay Off, Power On, and **Last State**.

## **►CPU Configuration**

The following CPU information will display:

### **CPU Signature**

- Intel® Xeon® CPU E3-1225 v5 @3.30GHz
- CPU Signature
- Microcode Patch
- Max CPU Speed
- Min CPU Speed
- CPU Speed

- Processor Cores
- Hyper Threading Technology
- Intel VT-x Technology
- Intel SMX Technology
- 64-bit
- EIST Technology
- CPU C3 State
- CPU C6 State
- CPU C7 State
- L1 Data Cache
- L1 Code Cache
- L2 Cache
- L3 Cache
- L4 Cache

#### **Hyper-threading (Available when supported by the CPU)**

Select Enabled to support Intel Hyper-threading Technology to enhance CPU performance. The options are **Enabled** and Disabled.

#### **Active Processor Cores**

This feature determines how many CPU cores will be activated for each CPU. When all is selected, all cores in the CPU will be activated. (Please refer to Intel's website for more information.) The options are **All**, 1,2, and 3.

#### **Intel Virtualization Technology**

Select Enable to use Intel Virtualization Technology so that I/O device assignments will be reported directly to the VMM (Virtual Memory Management) through the DMAR ACPI tables. This feature offers fully-protected I/O resource-sharing across the Intel platforms, providing the user with greater reliability, security and availability in networking and data-sharing. The settings are Disabled and **Enabled**.

**Hardware Prefetcher (Available when supported by the CPU)**

If set to Enabled, the hardware prefetcher will prefetch streams of data and instructions from the main memory to the L2 cache to improve CPU performance. The options are Disabled and **Enabled**.

**Adjacent Cache Line Prefetch (Available when supported by the CPU)**

Select Disabled for the CPU prefetcher to prefetch the cache line for 64 bytes. Select Enabled for the CPU prefetcher to prefetch both cache lines for 128 bytes as comprised. The options are Disabled and **Enabled**.

**CPU AES**

Select Enabled to enable Intel CPU Advanced Encryption Standard (AES) Instructions for CPU to enhance data integrity. The options are Disabled and **Enabled**.

**Boot Performance Mode**

Use this feature to select the performance state that the BIOS will set before the operating system handoff. The options are Power Saving, **Max Non-Turbo Performance**, and Turbo Performance.

**HardWare P-States (HWP)**

Use this feature to enable or disable hardware P-States support to enhance power management. The options are **Disabled** and Enabled.

**Intel® SpeedStep™**

Intel SpeedStep Technology allows the system to automatically adjust processor voltage and core frequency to reduce power consumption and heat dissipation. The options are Disabled and **Enabled**.

**Turbo Mode**

Select Enabled for processor cores to run faster than the frequency specified by the manufacturer. The options are Disabled and **Enabled**.

**Package Power Limit MSR Lock**

Select Enabled to lock the package power limit for the model specific registers. The options are **Disabled** and Enabled.

**Power Limit 1 Override**

Select Enabled to support average Power Limit (PL1) override. The options are **Disabled** and Enabled. When this feature is set to Enabled, the following items will display:

**Power Limit 1 (Available when "Power Limit Override" is set to Enabled)**

Use this feature to configure the Power Limit 1 setting in Milli Watts (for power) and in 125mW (for step size). For XE-based models, you can use any value for this setting. For Overclocking, please use a value between the maximum and minimum power

limits that are specified by the PACKAGE\_POWER\_SKU\_MSR. For other configuration, please use a value between the minimum power limit and the TDP Limit (Thermal Design Power Limit) per the Intel specs. Enter 0 for the BIOS to enter the manufacturer default as the TDP value. The default setting is **0**.

#### **Power Limit 1 Window (Available when the item above-Power Limit Override is set to Enabled)**

Use this feature to set the value of Power Limit 1 Time Window (in seconds). The value may vary from 0 to 128. If the value is set to 0, a default value will be used (28 sec for Mobile, and 1 sec for Desktop). The options are **0**, 1, 2, 3, 4, 5, 6, 7, 8, 10, 12, 14, 16, 20, 24, 28, 32, 40 and 48.

#### **Power Limit 2 Override**

Select Enabled to support rapid power limit (PL2) override. The default setting is **Enabled**. When this feature is set to Enabled, the following items will display:

##### **Power Limit 2**

Use this feature to configure the value for Power Limit 2. The value is in milli watts (for power) and 125mW (for step size). Use the number keys on your keyboard to enter the value. If the value is 0, the BIOS will set PL2 as 1.25\* TDP. Enter **0** to use the manufacture default setting.

##### **1-Core Ratio Limit Override**

This increases (multiplies) 1 clock speed in the CPU core in relation to the bus speed when one CPU core is active. Press "+" or "-" on your keyboard to change the value. Enter **0** to use the manufacture default setting.

##### **2-Core Ratio Limit Override**

This increases (multiplies) 2 clock speeds in the CPU core in relation to the bus speed when two CPU cores are active. Press "+" or "-" on your keyboard to change the value. Enter **0** to use the manufacture default setting.

##### **3-Core Ratio Limit Override**

This increases (multiplies) 3 clock speeds in the CPU core in relation to the bus speed when three CPU cores are active. Press "+" or "-" on your keyboard to change the value. Enter **0** to use the manufacture default setting.

##### **4-Core Ratio Limit Override**

This increases (multiplies) 4 clock speeds in the CPU core in relation to the bus speed when three CPU cores are active. Press "+" or "-" on your keyboard to change the value. Enter **0** to use the manufacture default setting.

#### **CPU C-States**

Use this feature to enable the C-State of the CPU to enhance power management. The options are Disabled and **Enabled**.

##### **Enhanced C-States**

Use this feature to enable the enhanced C-State of the CPU. The options are Disabled and **Enabled**.

**C-State Auto Demotion**

Use this feature to prevent unnecessary excursions into the C-states to improve latency. The options are Disabled, C1, C3, and **C1 and C3**.

**C-State Un-Demotion**

This feature allows the user to enable or disable the un-demotion of C-State. The options are Disabled, C1, C3, and **C1 and C3**

**Package C-State Demotion**

Use this feature to enable or disable the Package C-State demotion. The options are **Disabled** and Enabled.

**Package C-State Un-Demotion**

Use this feature to enable or disable the Package C-State un-demotion. The options are **Disabled** and Enabled.

**C-State Pre-Wake**

This feature allows the user to enable or disable the C-State Pre-Wake. The options are Disabled and **Enabled**.

**Package C-State Limit**

Use this feature to set the Package C-State limit. The options are C0/C1, C2, C3, C6, C7, C7s, C8, and **AUTO**.

**► CPU Thermal Configuration****CPU DTS**

Select Enabled for the ACPI thermal management to use the DTS SMM mechanism to obtain CPU temperature values. Select Disabled for EC to report the CPU temperature values. The options are **Disabled** and Enabled.

**ACPI 3.0 T-States**

Select Enabled to support CPU throttling by the operating system to reduce power consumption. The options are **Disabled** and Enabled.

**► Chipset Configuration**

**Warning:** Setting the wrong values in the following features may cause the system to malfunction.

**► System Agent (SA) Configuration**

The following System Agent information will display:

- System Agent Bridge Name

- SA PCIe Code Version
- VT-d

### **VT-d**

Select Enabled to enable Intel Virtualization Technology support for Direct I/O VT-d by reporting the I/O device assignments to VMM through the DMAR ACPI Tables. This feature offers fully-protected I/O resource-sharing across the Intel platforms, providing the user with greater reliability, security and availability in networking and data-sharing. The options are Disabled and **Enabled**.

### **Gaussian Mixture Model**

This feature is to enable or disable the System Agent Gaussian Mixture Model device. The options are Disabled and **Enabled**.

## **►Graphics Configuration**

### **Primary Display**

Use this feature to select a IGFX/PE/PCI graphics device to be used as the primary display. You can also select SG to use a Switchable Gfx device for your primary display.

The options are Auto, PEG, and **PCIE**.

### **Primary PCIE (PCI-Express Graphics)**

This feature allows the user to specify which graphics card to be used as the primary graphics device. The options are **Onboard**, PCH SLOT4 PCI-E 3.0 x1, and PCH SLOT5 PCI-E 3.0 x4(IN X8).

## **►DMI/OPI Configuration**

The following DMI information will display:

- DMI

### **DMI VC1 Control**

Use this feature to enable or disable DMI Virtual Channel 1. The options are Enabled and **Disabled**.

### **DMI VCm Control**

Use this feature to enable or disable the DMI Virtual Channel map. The options are **Enabled** and Disabled.

### **CPU DMI Link ASPM Control**



Use this feature to set the ASPM (Active State Power Management) state on the SA (System Agent) side of the DMI Link. The options are Disabled and **L1**.

#### **DMI Extended Sync Control**

Use this feature to enable or disable the DMI extended synchronization. The options are Enabled and **Disabled**.

#### **DMI De-Emphasis Control**

Use this feature to configure the De-emphasis control on DMI. The options are -6dB and **-3.5dB**.

### **► PEG Port Configuration**

#### **CPU SLOT6 PCI-E 3.0 X8(IN x16)**

##### **SLOT6 Max Link Speed**

This feature allows the user to select PCI-E support for the device installed on SLOT6. The options are **Auto**, Gen1, Gen2, and Gen3.

##### **SLOT6 Max Payload Size**

Use this feature to select the PEG0 maximum payload size. The options are **Auto**, 128 TLP, and 256 TLP.

##### **SLOT6 Power Limit Value**

Use this feature to set the upper limit on the power supplied by the PCIE slot. Press "+" or "-" on your keyboard to change this value. The default setting is **75**.

##### **SLOT6 Power Limit Scale**

Use this feature to select the scale used for the slot power limit value. The options are **1.0x**, 0.1x, 0.01x, and 0.001x.

#### **Program PCIe ASPM After OPROM**

PCIe ASPM, the Active State Power Management for PCI-Express slots, is a power management protocol used to manage power consumption of serial-link devices installed on PCI-Exp slots during a prolonged off-peak time. If this item is set to Enabled, PCI-E ASPM will be programmed after OPROM. If this item is set to Disabled, the PCI-E ASPM will be programmed before OPROM. The options are Disabled and **Enabled**.

### **► Memory Configuration**

The following memory information will display:

- Memory RC Version

- Memory Frequency
- Total Memory
- VDD
- DIMMA1
- DIMMA2
- DIMMB1
- DIMMB2
- Memory Timings (tCL-tRCD-tRP-tRAS)

### **Maximum Memory Frequency**

Use this feature to set the maximum memory frequency for onboard memory modules. The options are **Auto**, 1067, 1200, 1333, 1400, 1600, 1800, 1867, 2000, 2133, 2200, and 2400.

### **Max TOLUD**

This feature sets the maximum TOLUD value, which specifies the "Top of Low Usable DRAM" memory space to be used by internal graphics devices, GTT Stolen Memory, and TSEG, respectively when these devices are enabled. The options are **Dynamic**, 1 GB, 1.25 GB, 1.5 GB, 1.75 GB, 2 GB, 2.25 GB, 2.5 GB, 2.75 GB, 3 GB, 3.25 GB, and 3.5 GB.

### **Energy Performance Gain**

Use this feature to enable or disable the energy performance gain. The options are **Disabled** and **Enabled**.

### **Memory Scrambler**

Select **Enabled** to enable memory scrambler support. The options are **Disabled** and **Enabled**.

### **Fast Boot**

Use this feature to enable or disable fast path through the memory reference codes. The options are **Enabled** and **Disabled**.

### **REFRESH\_2X\_MODE**

Use this feature to select the refresh mode. The options are **Disabled**, 1- Enabled for WARM or HOT, and 2- Enabled HOT only.

### **Closed Loop Thermal Management**

Select **Enabled** to support Closed-Loop Thermal Management which will improve reliability and reduce CPU power consumption via automatic voltage control while the CPU are in idle states. The options are **Disabled** and **Enabled**.

## ► PCH-IO Configuration

The following PCH-IO information will display:

- Intel PCH RC Version
- Intel PCH SKU Name
- Intel PCH Rev ID

## ► PCI Express Configuration

### PCH DMI Link ASPM Control

Use this feature to set the ASPM (Active State Power Management) state on the SA (System Agent) side of the DMI Link. The options are Disabled and **Enabled**.

### Peer Memory Write Enable

Select Enabled for peer memory write support. The options are **Disabled** and Enabled.

## ► PCH SLOT4 PCI-E 3.0 X1

### Port 8 ASPM

Use this feature to set the Active State Power Management (ASPM) level for the PCI-E device installed on the port specified. Select Auto for the system BIOS to automatically set the ASPM level based on the system configuration. Select Disabled to disable ASPM support. The options are Disabled, L0s, L1, L0s & L1, and **Auto**.

### Port 8 L1 Substates

Use this feature to configure the PCI Express L1 Substates for the port specified. The options are Disabled, L1.1, L1.2, and **L1.1 & L1.2**

### Port 8 PCIe Speed

Use this feature to select the PCI Express speed for the PCI-E port specified. The options are **Auto**, Gen1, Gen2, and Gen3.

### Port 8 Detect Non-Compliance Device

If this feature is set to Enabled, the AMI BIOS will automatically detect a PCI-E device installed on the port specified that is not compliant with the PCI-E standards. The options are **Disabled** and Enabled.

## ► PCH SLOT5 PCI-E 3.0 X4(IN X8)

### Port 9 ASPM

Use this feature to set the Active State Power Management (ASPM) level for the PCI-E device installed on the port specified. Select Auto for the system BIOS to automatically set the ASPM level based on the system configuration. Select Disabled to disable ASPM support. The options are Disabled, L0s, L1, L0s & L1, and **Auto**.

### Port 9 L1 Substates

Use this feature to configure the PCI Express L1 Substates for the port specified. The options are Disabled, L1.1, L1.2, and **L1.1 & L1.2**

### Port 9 PCIe Speed

Use this feature to select the PCI Express speed for the PCI-E port specified. The options are **Auto**, Gen1, Gen2, and Gen3.

### Port 9 Detect Non-Compliance Device

If this feature is set to Enabled, the AMI BIOS will automatically detect a PCI-E device installed on the port specified that is not compliant with the PCI-E standards. The options are **Disabled** and Enabled.

## ► PCI Express Configuration

### Port 61h Bit-4 Emulation

Select Enabled to enable the emulation of Port 61h bit-4 toggling in SMM (System Management Mode). The options are Disabled and **Enabled**.

### PCIe PLL SSC

Select Enabled to enable Phase Locked Loop (PLL) support on the Spread Spectrum Clock (SSC) settings to help reduce Electromagnetic Interference caused by the components in the system. Select Disabled to enhance system stability. The options are **Disabled** and Enabled

## ► SATA Configuration

When this submenu is selected, the AMI BIOS automatically detects the presence of the SATA devices that are supported by the Intel PCH chip and displays the following items:

### SATA Controller(s)

This feature enables or disables the onboard SATA controller supported by the Intel PCH chip. The options are **Enabled** and Disabled.

**SATA Mode Selection**

Use this feature to select the mode for the installed SATA drives. The options are **AHCI** and RAID.

**SATA Frozen**

Use this feature to enable the HDD Security Frozen Mode. The options are **Disabled** and Enabled.

***\*If the item above "SATA Mode Selection" is set to AHCI, the following items will display:***

**Serial ATA Port 0~ Port 5**

This feature displays the information detected on the installed SATA drive on a SATA port specified by the user.

**Port 0 ~ Port 5 Software Preserve**

The status of software preserve of a SATA port will display as it is detected by the BIOS.

**Port 0 ~ Port 5 Spin Up Device**

On an edge detect from 0 to 1, set this item to allow the PCH to initialize the device. The options are **Disabled** and Enabled.

**Port 0 ~ Port 5 SATA Device Type**

Use this feature to specify if the SATA port specified by the user should be connected to a Solid State drive or a Hard Disk Drive. The options are **Hard Disk Drive** and Solid State Drive.

***\*If the item above "SATA Mode Selection" is set to RAID, the following items will display:***

**SATA RAID Option ROM/UEFI Driver**

Select UEFI to load the EFI driver for system boot. Select Legacy to load a legacy driver for system boot. The options are **Legacy ROM** and UEFI Driver.

**SATA Frozen**

Use this feature to enable the HDD Security Frozen Mode. The options are **Disabled** and Enabled.

**Serial ATA Port 0~ Port 5**

This feature displays the information detected on the installed SATA drive on a SATA port specified by the user.

**Port 0 ~ Port 5 Software Preserve**

The status of software preserve of a SATA port will display as it is detected by the BIOS.

**Port 0 ~ Port 5 Spin Up Device**

On an edge detect from 0 to 1, set this item to allow the PCH to initialize the device. The options are **Disabled** and Enabled.

#### **Port 0 ~ Port 5 SATA Device Type**

Use this feature to specify if the SATA port specified by the user should be connected to a Solid State drive or a Hard Disk Drive. The options are **Hard Disk Drive** and Solid State Drive.

### **►PCIe/PCI/PnP Configuration**

The following information will display:

PCI Bus Driver Version

PCI Devices Common Settings:

#### **PCI Latency Timer**

Use this feature to set the latency timer of each PCI device installed on a PCI bus. Select 32 to set the PCI latency to 32 PCI clock cycles. The options are **32 PCI Bus Clocks**, 64 PCI Bus Clocks, 96 PCI Bus Clocks, 128 PCI Bus Clocks, 160 PCI Bus Clocks, 192 PCI Bus Clocks, 224 PCI Bus Clocks, and 248 PCI Bus Clocks.

#### **PCI PERR/SERR Support**

Select Enabled to support PERR (PCI/PCI-E Parity Error)/SERR (System Error) runtime error reporting for a PCI/PCI-E slot. The options are **Disabled** and Enabled.

#### **Above 4G Decoding (Available if the system supports 64-bit PCI decoding)**

Select Enabled to decode a PCI device that supports 64-bit in the space above 4G Address. The options are **Disabled** and Enabled.

#### **CPU SLOT6 PCI-E 3.0 X8(IN X16) OPROM**

Use this feature to select which firmware type to be loaded for the add-on card in this slot for system boot. The options are Disabled, **Legacy**, and EFI.

#### **PCH SLOT5 PCI-E 3.0 X4(IN X8) OPROM**

Use this feature to select which firmware type to be loaded for the add-on card in this slot for system boot. The options are Disabled, **Legacy**, and EFI.

#### **PCH SLOT4 PCI-E 3.0 X1 OPROM**

Use this feature to select which firmware type to be loaded for the add-on card in this slot for system boot. The options are Disabled, **Legacy**, and EFI.

#### **Onboard SAS Option ROM**

Use this feature to select which firmware type to be loaded for the device installed in the onboard SAS slot for system boot. The options are Disabled, **Legacy**, and EFI.

### **Onboard LAN Option ROM Type**

Select Enabled to enable Option ROM support to boot the computer using a network device specified by the user. The options are **Legacy** and EFI.

### **Onboard LAN1 Option ROM**

Use this option to select the type of device installed in LAN Port1 for system boot. The options are Disabled, **PXE**, and iSCSI.

### **Onboard LAN2 Option ROM**

Use this option to select the type of device installed in LAN Port2 for system boot. The options are Disabled and **PXE**.

### **Onboard Video Option ROM**

Use this feature to select the Onboard Video Option ROM type. The options are Disabled, **Legacy**, and EFI.

### **Network Stack**

Select Enabled to enable PXE (Preboot Execution Environment) or UEFI (Unified Extensible Firmware Interface) for network stack support. The options are Disabled and **Enabled**.

### **IPv4 PXE Support**

Select Enabled to enable IPv4 PXE boot support. The options are Disabled and **Enabled**.

### **IPv6 PXE Support**

Select Enabled to enable IPv6 PXE boot support. The options are **Disabled** and Enabled.

### **PXE boot wait time**

Use this option to specify the wait time to press the ESC key to abort the PXE boot. Press "+" or "-" on your keyboard to change the value. The default setting is **0**.

### **Media detect count**

Use this option to specify the number of times media will be checked. Press "+" or "-" on your keyboard to change the value. The default setting is **1**.

## **► Super IO Configuration**

The following Super IO information will display:

- AMI SIO Driver Version

### **Super IO Chip Logical Device(s) Configuration**

#### **► Serial Port 1**

##### **► Serial Port 1 Configuration**

This submenu allows the user the configure settings of Serial Port 1.

Serial Port 1 Select Enabled to enable the selected onboard serial port. The options are **Enabled** and Disabled.

### **Logical Device Settings**

This feature displays the current status of a serial part specified by the user.

### **Serial Port 1 Change Settings**

This feature specifies the base I/O port address and the Interrupt Request address of a serial port specified by the user. Select Auto to allow the BIOS to automatically assign the base I/O and IRQ address.

The options for Serial Port 1 are **Use Automatic Settings**, (IO=3F8h; IRQ=4; DMA), (IO=3F8h; IRQ=3, 4, 5, 7, 9, 10, 11, 12; DMA), (IO=2F8h; IRQ=3, 4, 5, 7, 9, 10, 11, 12; DMA), (IO=3E8h; IRQ=3, 4, 5, 7, 9, 10, 11, 12; DMA), and (IO=2E8h; IRQ=3, 4, 5, 7, 9, 10, 11, 12; DMA).

## ► **Serial Port 2**

### ► **Serial Port 2 Configuration**

This submenu allows the user the configure settings of Serial Port 2.

### **Serial Port 2**

Select Enabled to enable the selected onboard serial port. The options are **Enabled** and Disabled.

### **Logical Device Settings**

This feature displays the current status of a serial part specified by the user.

### **Serial Port 2 Change Settings**

This feature specifies the base I/O port address and the Interrupt Request address of a serial port specified by the user. Select Auto to allow the BIOS to automatically assign the base I/O and IRQ address.

The options for Serial Port 2 are **Use Automatic Settings**, (IO=2F8h; IRQ=3; DMA), (IO=3F8h; IRQ=3, 4, 5, 7, 9, 10, 11, 12; DMA), (IO=2F8h; IRQ=3, 4, 5, 7, 9, 10, 11, 12; DMA), (IO=3E8h; IRQ=3, 4, 5, 7, 9, 10, 11, 12; DMA), and (IO=2E8h; IRQ=3, 4, 5, 7, 9, 10, 11, 12; DMA).

### **Serial Port 2 Attribute**

Select SOL to use COM Port 2 as a Serial\_Over\_LAN (SOL) port for console redirection. The options are **SOL** and COM.



## ► Intel Server Platform Services

Intel Server Platform Services Configuration

The following items will display as detected by the BIOS:

- ME BIOS Interface Version
- SPS Version
- ME FW (Firmware) Status Value
- ME FW (Firmware) State
- ME FW (Firmware) Operation State
- ME FW (Firmware) Error Code
- ME NM FW (Firmware) Status Value
- BIOS Booting Mode
- Cores Disabled
- ME FW (Firmware) SKU Information
- End-of-POST Status

## ► Serial Port Console Redirection

### COM1 Console Redirection

#### COM1 Console Redirection

Select Enabled to enable console redirection support for a serial port specified by the user. The options are **Disabled** and Enabled. If this feature is set to Enabled, the following items will become available:

### ► COM1 Console Redirection Settings

This feature allows the user to specify how the host computer will exchange data with the client computer, which is the remote computer used by the user.

#### COM1 Terminal Type

This feature allows the user to select the target terminal emulation type for Console Redirection. Select VT100 to use the ASCII Character set. Select VT100+ to add color and function key support. Select ANSI to use the Extended ASCII Character Set. Select VT-UTF8

to use UTF8 encoding to map Unicode characters into one or more bytes. The options are VT100, **VT100+**, VT-UTF8, and ANSI.

#### **COM1 Bits Per second**

Use this feature to set the transmission speed for a serial port used in Console Redirection. Make sure that the same speed is used in the host computer and the client computer. A lower transmission speed may be required for long and busy lines. The options are 9600, 19200, 38400, 57600, and **115200** (bits per second).

#### **COM1 Data Bits**

Use this feature to set the data transmission size for Console Redirection. The options are 7 (Bits) and **8 (Bits)**.

#### **COM1 Parity**

A parity bit can be sent along with regular data bits to detect data transmission errors. Select Even if the parity bit is set to 0, and the number of 1's in data bits is even. Select Odd if the parity bit is set to 0, and the number of 1's in data bits is odd. Select None if you do not want to send a parity bit with your data bits in transmission. Select Mark to add a mark as a parity bit to be sent along with the data bits. Select Space to add a Space as a parity bit to be sent with your data bits. The options are **None**, Even, Odd, Mark and Space.

#### **COM1 Stop Bits**

A stop bit indicates the end of a serial data packet. Select 1 Stop Bit for standard serial data communication. Select 2 Stop Bits if slower devices are used. The options are **1** and 2.

#### **COM1 Flow Control**

Use this feature to set the flow control for Console Redirection to prevent data loss caused by buffer overflow. Send a "Stop" signal to stop sending data when the receiving buffer is full. Send a "Start" signal to start sending data when the receiving buffer is empty. The options are **None** and Hardware RTS/CTS.

#### **COM1 VT-UTF8 Combo Key Support**

Select Enabled to enable VT-UTF8 Combination Key support for ANSI/VT100 terminals. The options are **Enabled** and Disabled.

#### **COM1 Recorder Mode**

Select Enabled to capture the data displayed on a terminal and send it as text messages to a remote server. The options are **Disabled** and Enabled.

#### **COM1 Resolution 100x31**

Select Enabled for extended-terminal resolution support. The options are Disabled and **Enabled**.

### **COM1 Legacy OS Redirection Resolution**

Use this feature to select the number of rows and columns used in Console Redirection for legacy OS support. The options are 80x24 and **80x25**.

### **COM1 Putty KeyPad**

This feature selects the settings for Function Keys and KeyPad used for Putty, which is a terminal emulator designed for the Windows OS. The options are **VT100**, LINUX, XTERMR6, SC0, ESCN, and VT400.

### **COM1 Redirection After BIOS POST**

Use this feature to enable or disable legacy console redirection after BIOS POST (Power-On Self-Test). When this feature is set to BootLoader, legacy console redirection is disabled before booting the OS. When set to Always Enable, legacy console redirection remains enabled when booting the OS. The options are **Always Enable** and BootLoader.

### **SOL (Serial-Over-LAN)/COM2 Console Redirection**

Select Enabled to use the SOL port for Console Redirection. The options are Disabled and **Enabled**.

*\*If the item above set to Enabled, the following items will become available for user's configuration:*

### **► SOL/COM2 Console Redirection Settings**

Use this feature to specify how the host computer will exchange data with the client computer, which is the remote computer used by the user.

#### **COM2 Terminal Type**

Use this feature to select the target terminal emulation type for Console Redirection. Select VT100 to use the ASCII Character set. Select VT100+ to add color and function key support. Select ANSI to use the Extended ASCII Character Set. Select VT-UTF8 to use UTF8 encoding to map Unicode characters into one or more bytes. The options are VT100, **VT100+**, VT-UTF8, and ANSI.

#### **COM2 Bits Per second**

Use this feature to set the transmission speed for a serial port used in Console Redirection. Make sure that the same speed is used in the host computer and the client computer. A lower transmission speed may be required for long and busy lines. The options are 9600, 19200, 38400, 57600 and **115200** (bits per second).

#### **COM2 Data Bits**

Use this feature to set the data transmission size for Console Redirection. The options are 7 (Bits) and **8 (Bits)**.

### COM2 Parity

A parity bit can be sent along with regular data bits to detect data transmission errors. Select Even if the parity bit is set to 0, and the number of 1's in data bits is even. Select Odd if the parity bit is set to 0, and the number of 1's in data bits is odd. Select None if you do not want to send a parity bit with your data bits in transmission. Select Mark to add a mark as a parity bit to be sent along with the data bits. Select Space to add a Space as a parity bit to be sent with your data bits. The options are **None**, Even, Odd, Mark and Space.

### COM2 Stop Bits

A stop bit indicates the end of a serial data packet. Select 1 Stop Bit for standard serial data communication. Select 2 Stop Bits if slower devices are used. The options are **1** and **2**.

### COM2 Flow Control

Use this feature to set the flow control for Console Redirection to prevent data loss caused by buffer overflow. Send a "Stop" signal to stop sending data when the receiving buffer is full. Send a "Start" signal to start sending data when the receiving buffer is empty. The options are **None** and Hardware RTS/CTS.

### COM2 VT-UTF8 Combo Key Support

Select Enabled to enable VT-UTF8 Combination Key support for ANSI/VT100 terminals. The options are Disabled and **Enabled**.

### COM2 Recorder Mode

Select Enabled to capture the data displayed on a terminal and send it as text messages to a remote server. The options are **Disabled** and Enabled.

### COM2 Resolution 100x31

Select Enabled for extended-terminal resolution support. The options are Disabled and **Enabled**.

### COM2 Legacy OS Redirection Resolution

Use this feature to select the number of rows and columns used in Console Redirection for legacy OS support. The options are 80x24 and **80x25**.

### COM2 Putty KeyPad

This feature selects Function Keys and KeyPad settings for Putty, which is a terminal emulator designed for the Windows OS. The options are **VT100**, LINUX, XTERMR6, SCO, ESCN, and VT400.

### COM2 Redirection After BIOS POST

Use this feature to enable or disable legacy Console Redirection after BIOS POST. When set to BootLoader, legacy Console Redirection is disabled before booting the OS. When set

to Always Enable, legacy Console Redirection remains enabled when booting the OS. The options are **Always Enable** and BootLoader.

### **Serial Port for Out-of-Band Management/Windows Emergency Services**

#### **EMS Console Redirection**

Select Enabled to use a serial port specified by the user for Console Redirection for Out-Of-Band/Windows Emergency Services. The options are **Disabled** and Enabled.

*\*If the item above set to Enabled, the following items will become available for user's configuration:*

#### **►EMS Console Redirection Settings**

This feature allows the user to specify how the host computer will exchange data with the client computer, which is the remote computer used by the user.

#### **Out-of-Band Management Port**

The feature selects a serial port in a client server to be used by the Microsoft Windows Emergency Management Services (EMS) to communicate with a remote host server. The options are **COM1** and SOL/COM2.

#### **Terminal Type**

Use this feature to select the target terminal emulation type for Console Redirection. Select VT100 to use the ASCII character set. Select VT100+ to add color and function key support. Select ANSI to use the extended ASCII character set. Select VT-UTF8 to use UTF8 encoding to map Unicode characters into one or more bytes. The options are VT100, VT100+, **VT-UTF8**, and ANSI.

#### **Bits Per Second**

This feature sets the transmission speed for a serial port used in Console Redirection. Make sure that the same speed is used in the host computer and the client computer. A lower transmission speed may be required for long and busy lines. The options are 9600, 19200, 57600, and **115200** (bits per second).

#### **Flow Control**

Use this feature to set the flow control for Console Redirection to prevent data loss caused by buffer overflow. Send a "Stop" signal to stop sending data when the receiving buffer is full. Send a "Start" signal to start sending data when the receiving buffer is empty. The options are **None**, Hardware RTS/CTS, and Software Xon/Xoff.

*\*When EMS Console Redirection is set to Enabled, the following items will be displayed as detected by the AMI BIOS:*

**Data Bits**

This feature displays the data transmission size for Console Redirection.

**Parity**

This feature displays the setting of parity-bit that is sent along with regular data bits to detect data transmission errors.

**Stop Bits**

This feature displays the status of the stop-bit setting for Console Redirection. A stop bit indicates the end of a serial data packet.

**►ACPI Settings****High Precision Event Timer**

Select Enabled to activate the High Performance Event Timer (HPET) that produces periodic interrupts at a much higher frequency than a Real-time Clock (RTC) does in synchronizing multimedia streams, providing smooth playback and reducing the dependency on other timestamp calculation devices, such as an x86 RDTSC Instruction embedded in the CPU. The High Performance Event Timer is used to replace the 8254 Programmable Interval Timer. The options are Disabled and **Enabled**.

**WHEA Support**

Select Enabled to enable support for the Windows Hardware Error Architecture (WHEA) support for the Windows 2008 (or a later version) operating system. The options are Disabled and **Enabled**.

**►Trusted Computing (Available when a TPM device is installed and the onboard TPM jumper is enabled)****Configuration****Device Select**

Use this feature to select the TPM version. TPM 1.2 will restrict support to TPM 1.2 devices. TPM 2.0 will restrict support for TPM 2.0 devices. Select Auto to enable support for both versions. The options are TPM 1.2, TPM 2.0, and **Auto**.

**Current Status Information****TXT Support**

Intel TXT (Trusted Execution Technology) helps protect against software-based attacks and ensures protection, confidentiality and integrity of data stored or created on the system. Use this feature to enable or disable TXT Support. The options are **Disabled** and Enabled.

## ▶ **iSCSI Configuration**

### **iSCSI Initiator Name**

This feature allows the user to enter the unique name of the iSCSI Initiator in the IQN format. Once the name of the iSCSI Initiator is entered into the system, configure the proper settings for the following items:

#### ▶ **Add an Attempt**

#### ▶ **Delete Attempts**

#### ▶ **Change Attempt Order**

## 4.4 Event Logs

This submenu allows the user to configure Event Log settings.

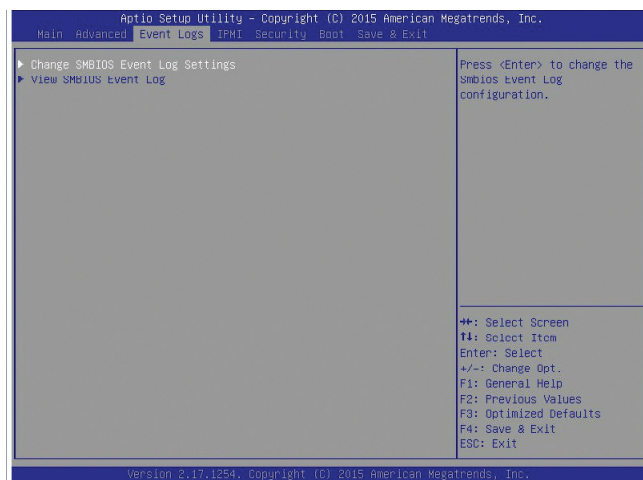

### ►Change SMBIOS Event Log Settings

This feature allows the user to configure SMBIOS Event settings.

#### Enabling/Disabling Options

##### SMBIOS Event Log

Select Enabled to enable SMBIOS (System Management BIOS) Event Logging during system boot. The options are Disabled and **Enabled**.

#### Erasing Settings

##### Erase Event Log

Select Yes to erase all error events in the SMBIOS (System Management BIOS) log before an event logging is initialized at bootup. The options are **No**, Yes, Next reset, and Yes, every reset.

##### When Log is Full

Select Erase Immediately to immediately erase all errors in the SMBIOS event log when the event log is full. Select Do Nothing for the system to do nothing when the SMBIOS event log is full. The options are **Do Nothing** and Erase Immediately.

#### SMBIOS Event Log Standard Settings

##### Log System Boot Event

Select Enabled to log system boot events. The options are Enabled and **Disabled**.



**MECI (Multiple Event Count Increment)**

Enter the increment value for the multiple event counter. Enter a number between 1 to 255. The default setting is 1.

**METW (Multiple Event Count Time Window)**

This feature is used to determine how long (in minutes) the multiple event counter should wait before generating a new event log. Enter a number between 0 to 99. The default setting is 60.



**Note:** Please reboot the system for the changes to take effect.

**►View SMBIOS Event Log**

This feature allows the user to view the event in the SMBIOS event log. The following categories are displayed:

**Date/Time/Error Code/Severity**

**4.5 IPMI**

This submenu allows the user to configure Intelligent Platform Management Interface (IPMI) settings.

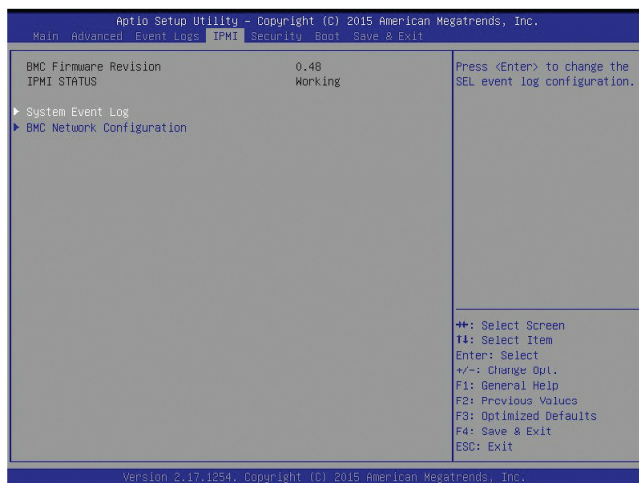

The following IPMI information will be displayed:

- BMC Firmware Revision
- IPMI STATUS

## ►System Event Log

### Enabling/Disabling Options

#### SEL Components

Select Enabled to enable all system event logging support at bootup. The options are **Enabled** and Disabled.

#### Erasing Settings

##### Erase SEL

Select Yes, On next reset to erase all system event logs upon next system reboot. Select Yes, On every reset to erase all system event logs upon each system reboot. Select No to keep all system event logs after each system reboot. The options are **No**, Yes, On next reset, and Yes, On every reset.

##### When SEL is Full

This feature allows the user to determine what the AMI BIOS should do when the system event log is full. Select Erase Immediately to erase all events in the log when the system event log is full. The options are **Do Nothing** and Erase Immediately.



**Note:** After making changes on a setting, be sure to reboot the system for the changes to take effect.

## ►BMC Network Configuration

The following items will be displayed:

- IPMI LAN Selection
- IPMI Network Link Status

#### Update IPMI LAN Configuration

Select Yes for the system BIOS to automatically reset the following IPMI settings upon next system boot. The options are Yes and **No**.

**Configuration Address Source (Available when the item above - Update IPMI LAN Configuration is set to Yes)**

Use this feature to select the IP address source for this computer. If Static is selected, you will need to know the IP address of this computer and enter it to the system manually in the field. If DHCP is selected, AMI BIOS will search for a DHCP (Dynamic Host Configuration Protocol) server attached to the network and request the next available IP address for this computer. The options are **DHCP** and Static.

**Station IP Address**

This feature displays the Station IP address for this computer. This should be in decimal and in dotted quad form (i.e., 192.168.10.253).

**Subnet Mask**

This feature displays the sub-network that this computer belongs to. The value of each three-digit number is separated by dots and it should not exceed 255.

**Station MAC Address**

This feature displays the Station MAC address for this computer. MAC addresses are 6 two-digit hexadecimal numbers.

**Gateway IP Address**

This feature displays the Gateway IP address for this computer. This should be in decimal and in dotted quad form (i.e., 172.31.0.1).

## 4.6 Security

This menu allows the user to configure the following security settings for the system.

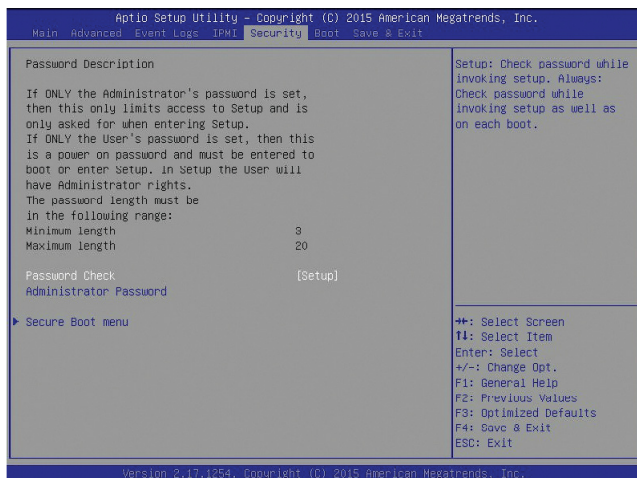

### Password Check

Select Setup for the system to check for a password at Setup. Select Always for the system to check for a password at bootup or upon entering the BIOS Setup utility. The options are **Setup** and Always.

### Administrator Password

Press Enter to create a new administrator password or change an existing administrator password.

### User Password

Press <Enter> to create a new user password or to change an existing user password.

### ► Secure Boot Menu

This section displays the contents of the following secure boot features:

- System Mode
- Secure Boot
- Vendor Keys

### Secure Boot

Use this feature to enable secure boot. The options are **Disabled** and Enabled.

### Secure Boot Mode

Use this feature to select the secure boot mode. The options are Standard and **Custom**.

## **CSM Support**

Select Enabled to support the EFI Compatibility Support Module (CSM), which provides compatibility support for traditional legacy BIOS for system boot. The options are Disabled and **Enabled**.

## **▶Key Management**

This submenu allows the user to configure the following Key Management settings.

### **Provision Factory Default Keys (Available when the system is in Setup Mode)**

Select Enabled to install factory default secure-boot keys. The options are Enabled and **Disabled**.

## **▶Enroll All Factory Default Keys**

This feature allows the user to store security-related boot data in a file of the same named in the system root folder of your computer.

## **▶Save All Secure Boot Variables**

This feature allows the user to save the secure boot settings specified by the user.

**Secure Boot Variables: Size/Key#/Key Source**

## **▶Platform Key (PK): Size/Key#/Key Source**

## **▶Key Exchange Keys: Size/Key#/Key Source**

## **▶Authorized Signatures: Size/Key#/Key Source**

## **▶Forbidden Signatures: Size/Key#/Key Source**

## **▶Authorized TimeStamps: Size/Key#/Key Source**

## 4.7 Boot

This submenu allows the user to configure Boot settings for this system:

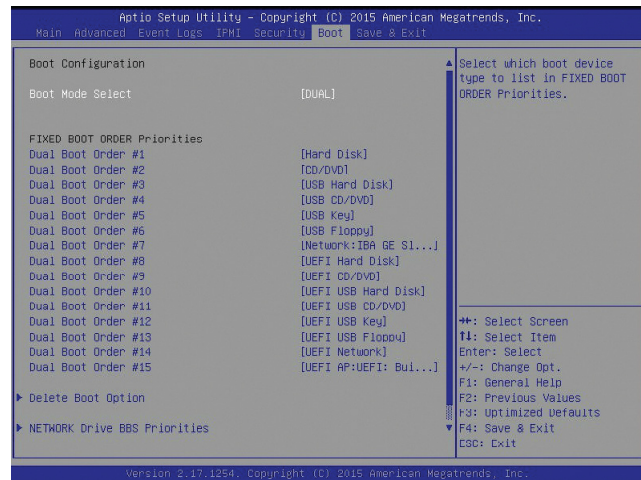

### Boot Configuration

#### Boot Mode Select

Use this feature to select the type of device to be used for system boot. The options are Legacy, UEFI, and **DUAL**.

#### Fixed Boot Order Priorities

This option prioritizes the order of bootable devices from which the system will boot. Press <Enter> on each entry from top to bottom to select devices.

- When the feature above -"Boot Mode Select" is set to Dual (default), the following items will be displayed for configuration:

Boot Option #1 - Boot Option #15

- When the item above -"Boot Mode Select" is set to Legacy, the following items will be display for configuration:

Boot Option #1 - Boot Option #7

- When the item above -"Boot Mode Select" is set to UEFI, the following items will be display for configuration:

Boot Option #1 - Boot Option #8

**▶ Add New Boot Option**

Use this item to select a new boot device to add to the boot priority list.

**Add New Boot Option**

Use this feature to select a new boot device to add to the boot priority list.

**▶ Delete Boot Option**

Use this feature to select a boot device to delete from the boot priority list.

**Delete Boot Option**

Use this feature to select the target boot device to delete from the boot priority list.

**▶ Hard Disk Drive BBS Priorities**

- Legacy Boot Order #1

**▶ NETWORK Drive BBS Priorities**

- Legacy Boot Order #1

**▶ UEFI Application Boot Priorities**

- UEFI Boot Order #1

## 4.8 Save & Exit

Select the Exit tab from the BIOS setup utility screen to enter the Exit BIOS Setup screen.

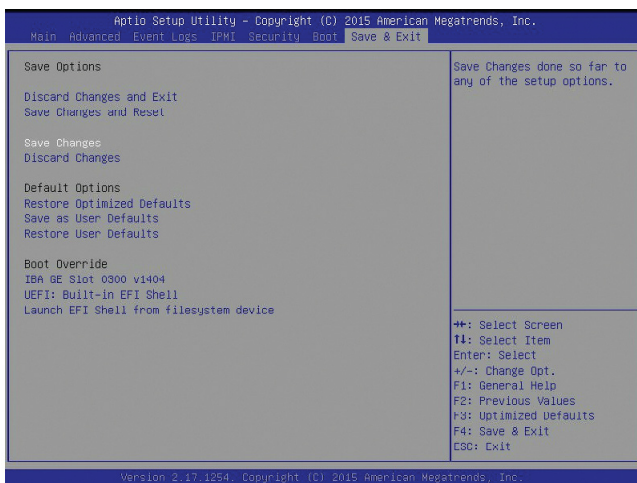

### Save Options

#### Discard Changes and Exit

Select this option to quit the BIOS Setup without making any permanent changes to the system configuration, and reboot the computer. Select Discard Changes and Exit from the Exit menu and press <Enter>.

#### Save Changes and Reset

When you have completed the system configuration changes, select this option to leave the BIOS setup utility and reboot the computer so that the new system configuration parameters can take effect. Select Save Changes and Exit from the Exit menu and press <Enter>.

#### Save Changes

After completing the system configuration changes, select this option to save the changes you have made. This will not reset (reboot) the system.

#### Discard Changes

Select this option and press <Enter> to discard all the changes and return to the AMI BIOS utility Program.

#### Default Options

#### Restore Optimized Defaults

Select this option and press <Enter> to load the manufacturer default settings that are designed for maximum system performance, but not for maximum security.



**Save as User Defaults**

Select this option and press <Enter> to save changes made to the BIOS setup settings for future use.

**Restore User Defaults**

Select this option and press <Enter> to retrieve user-defined settings that were saved previously.

**Boot Override**

Listed on this section are other boot options for the system (i.e., Built-in EFI shell). Select an option and press <Enter>. Your system will boot to the selected boot option.

## Appendix A

### BIOS Codes

#### BIOS Error POST (Beep) Codes

During the POST (Power-On Self-Test) routines, which are performed upon each system boot, errors may occur.

**Non-fatal errors** are those which, in most cases, allow the system to continue to boot. These error messages normally appear on the screen.

**Fatal errors** will not allow the system to continue with bootup. If a fatal error occurs, you should consult with your system manufacturer for possible repairs.

These fatal errors are usually communicated through a series of audible beeps. The numbers on the fatal error list correspond to the number of beeps for the corresponding error.

BIOS Beep (POST) Codes		
Beep Code	Error Message	Description
1 beep	Refresh	Ready to boot
5 short, 1 long	Memory error	No memory detected in system
5 beeps	No con-in or con-out devices	Con-in includes USB or PS/2 keyboard, PCI or serial console redirection, and IPMI KVM or SOL. Con-out includes the video controller, PCI or serial console redirection, and IPMI SOL
1 beep per device	Refresh	1 beep for each USB device detected

IPMI Error Codes		
Beep Code	Error Message	Description
1 long continuous	System OH	System overheat condition

# Appendix B

## Software Installation

### B.1 Installing Software Programs

The Supermicro FTP site contains drivers and utilities for your system at <ftp://ftp.supermicro.com>. Some of these must be installed, such as the chipset driver.

After accessing the FTP site, go into the CDR\_Images directory and locate the ISO file for your motherboard. Download this file to create a CD/DVD of the drivers and utilities it contains. (You may also use a utility to extract the ISO file if preferred.)

Another option is to go to the Supermicro website at <http://www.supermicro.com/products/>. Find the product page for your motherboard here, where you may download individual drivers and utilities.

After creating a CD/DVD with the ISO files, insert the disk into the CD/DVD drive on your system, and the following screen should appear.

 **Note 1:** Click the icons showing a hand writing on paper to view the readme files for each item. Click the computer icons to the right of these items to install each item (from top to the bottom) one at a time. **After installing each item, you must reboot the system before moving on to the next item on the list.** The bottom icon with a CD on it allows you to view the entire contents.

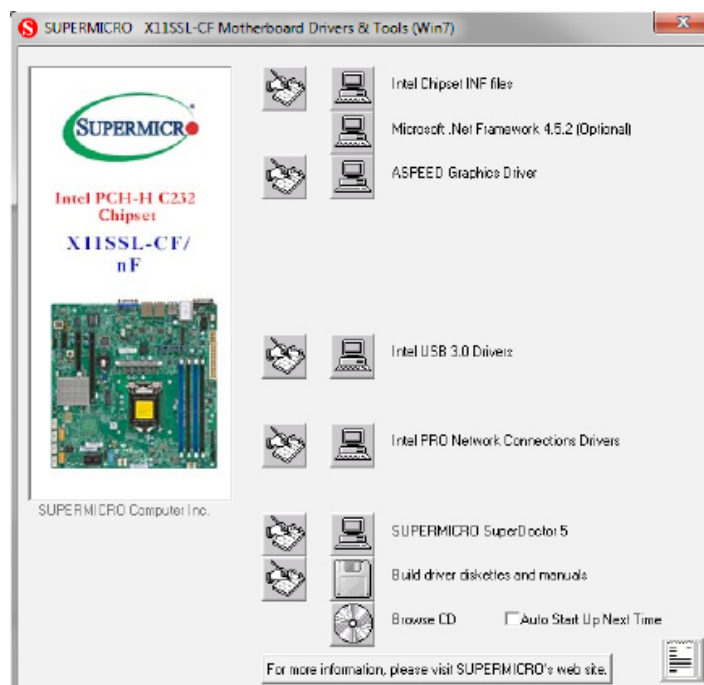



Figure B-1. Driver/Tool Installation Display Screen

**Note 2:** When making a storage driver diskette by booting into a driver CD, please set the SATA configuration to *Compatible Mode*, and configure the SATA as IDE in the BIOS setup. After making the driver diskette, be sure to change the SATA settings back to your original settings.

## B.2 SuperDoctor® 5

The Supermicro SuperDoctor 5 is a hardware monitoring program that functions in a command-line or web-based interface in Windows and Linux operating systems. The program monitors system health information, such as CPU temperature, system voltages, system power consumption, and fan speed, and provides alerts via email or the Simple Network Management Protocol (SNMP).

SuperDoctor 5 comes in local and remote management versions and can be used with Nagios to maximize your system monitoring needs. With the SuperDoctor 5 Management Server (SSM Server), you can remotely control the power status and reset chassis intrusion for multiple systems with SuperDoctor 5 or IPMI. SD5 Management Server monitors HTTP, FTP, and SMTP services to optimize the efficiency of your operation.

 **Note:** The default username and password for SuperDoctor 5 is admin/admin.

**Figure B-2. SuperDoctor 5 Interface Display Screen (Health Information)**

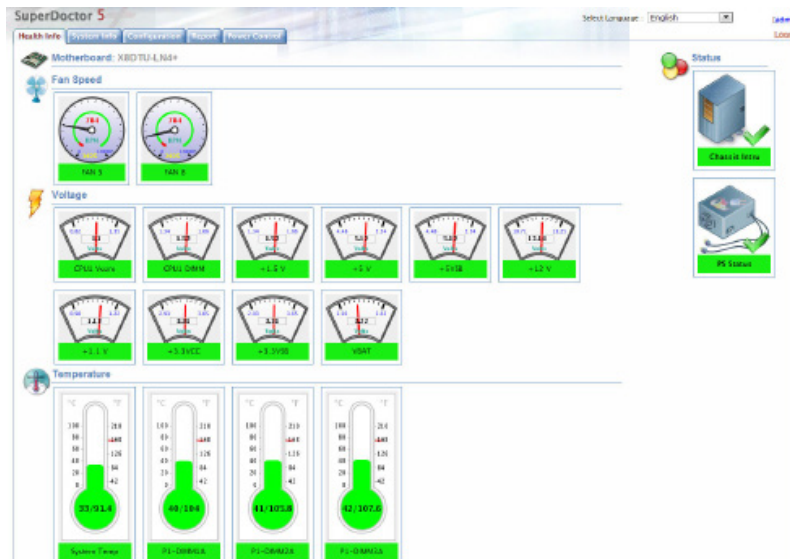

 **Note:** The SuperDoctor 5 program and user's manual can be downloaded from the Supermicro website at [http://www.supermicro.com/products/nfo/sms\\_sd5.cfm](http://www.supermicro.com/products/nfo/sms_sd5.cfm).

## Appendix C

### Standardized Warning Statements

The following statements are industry standard warnings, provided to warn the user of situations which have the potential for bodily injury. Should you have questions or experience difficulty, contact Supermicro's Technical Support department for assistance. Only certified technicians should attempt to install or configure components.

Read this section in its entirety before installing or configuring components.

These warnings may also be found on our website at [http://www.supermicro.com/about/policies/safety\\_information.cfm](http://www.supermicro.com/about/policies/safety_information.cfm).

#### Battery Handling



**Warning!** There is the danger of explosion if the battery is replaced incorrectly. Replace the battery only with the same or equivalent type recommended by the manufacturer. Dispose of used batteries according to the manufacturer's instructions

#### 電池の取り扱い

電池交換が正しく行われなかった場合、破裂の危険性があります。交換する電池はメーカーが推奨する型、または同等のものを使用下さい。使用済電池は製造元の指示に従って処分して下さい。

#### 警告

電池更換不當會有爆炸危險。請只使用同類電池或制造商推薦的功能相當的電池更換原有電池。請按製造商的說明處理廢舊電池。

#### 警告

電池更換不當會有爆炸危險。請使用製造商建議之相同或功能相當的電池更換原有電池。請按照製造商的說明指示處理廢棄舊電池。

#### Warnung

Bei Einsetzen einer falschen Batterie besteht Explosionsgefahr. Ersetzen Sie die Batterie nur durch den gleichen oder vom Hersteller empfohlenen Batterietyp. Entsorgen Sie die benutzten Batterien nach den Anweisungen des Herstellers.

Attention

Danger d'explosion si la pile n'est pas remplacée correctement. Ne la remplacer que par une pile de type semblable ou équivalent, recommandée par le fabricant. Jeter les piles usagées conformément aux instructions du fabricant.

¡Advertencia!

Existe peligro de explosión si la batería se reemplaza de manera incorrecta. Reemplazar la batería exclusivamente con el mismo tipo o el equivalente recomendado por el fabricante. Desechar las baterías gastadas según las instrucciones del fabricante.

**⚠️⚠️⚠️**  
**קיימת סכנת פיצוץ של הסוללה במקרה החלפה בדרך לא נכונה. יש להחליף את הסוללה בלבד המצוין על ידי היצרן המומלץ.**  
**סילוק הסוללות והמחזוריות יש לבצע לפי הוראות היצרן.**

**هناك خطر من انفجار في حالة استبدال البطارية بطريقة غير صحيحة. يجب استبدال البطارية فقط بنفس النوع أو ما يعادلها كما أوصت به الشركة المصنعة. التخلص من البطاريات المستخدمة وفقاً لتعليمات الشركة المصنعة.**

경고!

배터리가 올바르게 교체되지 않으면 폭발의 위험이 있습니다. 기존 배터리와 동일하거나 제조사에서 권장하는 동등한 종류의 배터리로만 교체해야 합니다. 제조사의 안내에 따라 사용된 배터리를 처리하여 주십시오.

Waarschuwing

Er is ontploffingsgevaar indien de batterij verkeerd vervangen wordt. Vervang de batterij slechts met hetzelfde of een equivalent type die door de fabrikant aanbevolen wordt. Gebruikte batterijen dienen overeenkomstig fabrieksvoorschriften afgevoerd te worden.

## Product Disposal



**Warning!** Ultimate disposal of this product should be handled according to all national laws and regulations.

### 製品の廃棄

この製品を廃棄処分する場合、国の関係する全ての法律・条例に従い処理する必要があります。

### 警告

本产品的废弃处理应根据所有国家的法律和规章进行。

### 警告

本產品的廢棄處理應根據所有國家的法律和規章進行。

### Warnung

Die Entsorgung dieses Produkts sollte gemäß allen Bestimmungen und Gesetzen des Landes erfolgen.

### ¡Advertencia!

Al deshacerse por completo de este producto debe seguir todas las leyes y reglamentos nacionales.

### Attention

La mise au rebut ou le recyclage de ce produit sont généralement soumis à des lois et/ou directives de respect de l'environnement. Renseignez-vous auprès de l'organisme compétent.

### תאריך הסתרת

### אזהרה!

טיפול סופי של קוטרי זה חייב להיות בטוחים להסרת הסכנה והסכנה הקטנה.

عند التخلص النهائي من هذا المنتج يتعين التعامل معه وفقاً لجميع القوانين واللوائح الوطنية

### 경고!

이 제품은 해당 국가의 관련 법규 및 규정에 따라 폐기되어야 합니다.

### Waarschuwing

De uiteindelijke verwijdering van dit product dient te geschieden in overeenstemming met alle nationale wetten en reglementen.

## Appendix D

### UEFI BIOS Recovery

**Warning:** Do not upgrade the BIOS unless your system has a BIOS-related issue. Flashing the wrong BIOS can cause irreparable damage to the system. In no event shall Supermicro be liable for direct, indirect, special, incidental, or consequential damages arising from a BIOS update. If you need to update the BIOS, do not shut down or reset the system while the BIOS is updating to avoid possible boot failure.

#### D.1 Overview

The Unified Extensible Firmware Interface (UEFI) provides a software-based interface between the operating system and the platform firmware in the pre-boot environment. The UEFI specification supports an architecture-independent mechanism for add-on card initialization to allow the UEFI OS loader, which is stored in the add-on card, to boot the system. The UEFI offers a clean, hands-off control to a computer system at bootup.

#### D.2 Recovering the UEFI BIOS Image

A UEFI BIOS flash chip consists of a recovery BIOS block and a main BIOS block (a main BIOS image). The boot block contains critical BIOS codes, including memory detection and recovery codes for the user to flash a new BIOS image if the original main BIOS image is corrupted. When the system power is on, the boot block codes execute first. Once it is completed, the main BIOS code will continue with system initialization and bootup.



**Note:** Follow the BIOS recovery instructions below for BIOS recovery when the main BIOS boot crashes. However, when the BIOS boot block crashes, you will need to follow the procedures below for BIOS recovery.

#### D.3 Recovering the BIOS Block with a USB Device

This feature allows the user to recover a BIOS image using a USB-attached device without additional utilities used. A USB flash device such as a USB Flash Drive, or a USB CD/DVD ROM/RW device can be used for this purpose. However, a USB Hard Disk drive cannot be used for BIOS recovery at this time.

The file system supported by UEFI is FAT (including FAT12, FAT16, and FAT32) installed on a bootable or non-bootable USB-attached device. However, the BIOS might need several



minutes to locate the SUPER.ROM file if the media size becomes too large because it contains too many folders and files.

To perform UEFI BIOS recovery using a USB-attached device, follow the instructions below.

1. Using a different machine, copy the "Super.ROM" binary image file into the disc Root "" Directory of a USB device or a writeable CD/DVD.

 **Note:** If you cannot locate the "Super.ROM" file in your driver disk, visit our website at [www.supermicro.com](http://www.supermicro.com) to download the BIOS image into a USB flash device and rename it "Super.ROM" for BIOS recovery use.

2. Insert the USB device that contains the new BIOS image ("Super.ROM") into your USB drive and power on the system
3. While powering on the system, please keep pressing <Ctrl> and <Home> simultaneously on your keyboard until the following screen (or a screen similar to the one below) displays.

**Warning:** Please **stop** pressing the <Ctrl> and <Home> keys immediately when you see the screen (or a similar screen) below; otherwise, it will trigger a system reboot.



 **Note:** On the other hand, if the following screen displays, please load the "Super.ROM" file to the root folder and connect this folder to the system. (You can do so by inserting a USB device that contains the new "Super.ROM" image to your machine for BIOS recovery.)



4. After locating the new BIOS binary image, the system will enter the BIOS Recovery menu as shown below.

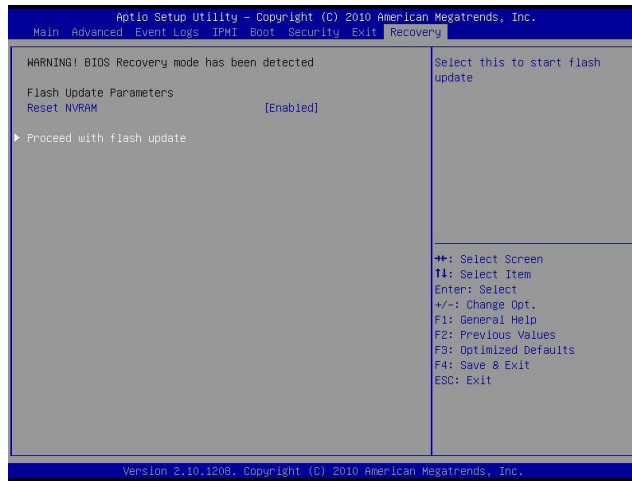

 **Note:** At this point, you may decide if you want to start the BIOS recovery. If you decide to proceed with BIOS recovery, follow the procedures below.

5. When the screen as shown above displays, use the arrow keys to select the item "Proceed with flash update" and press the <Enter> key. You will see the BIOS recovery progress as shown in the screen below.

 **Note:** Do not interrupt the BIOS flashing process until it has completed.

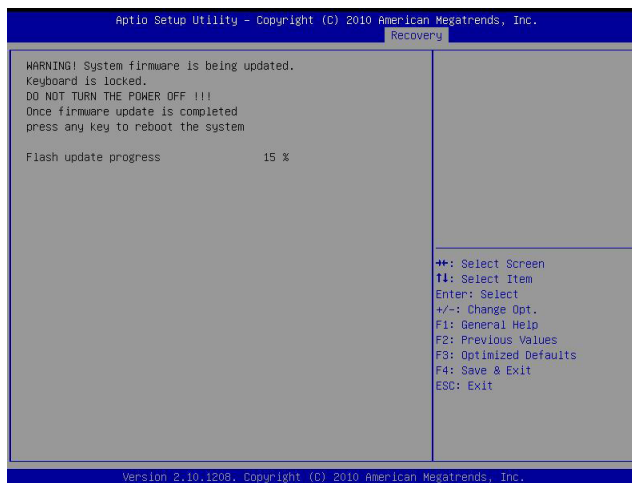

6. After the BIOS recovery process has completed, press any key to reboot the system.

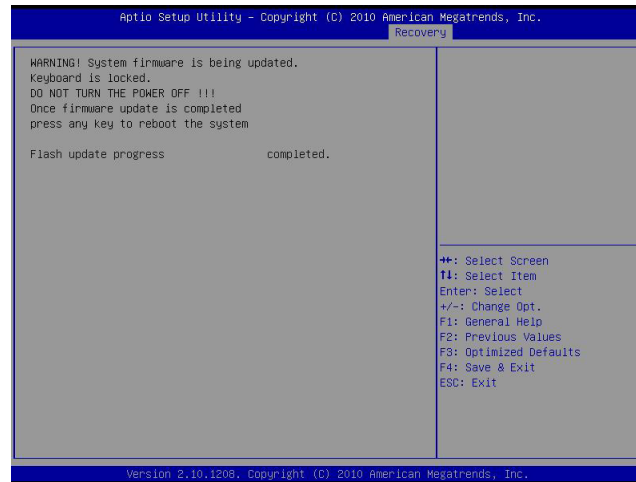

7. Using a different system, extract the BIOS package into a bootable USB flash drive.

8. When a DOS prompt appears, enter FLASH.BAT BIOSname.### at the prompt.

 **Note:** Do not interrupt this process until the BIOS flashing is complete.

9. After seeing the message that BIOS update has completed, unplug the AC power cable from the power supply, clear CMOS, then plug the AC power cable in the power supply again to power on the system.

10. Press <Del> continuously to enter the BIOS Setup utility.

11. Press <F3> to load the default settings.

12. After loading the default settings, press <F4> to save the settings and exit the BIOS Setup utility.

## Appendix E

### Dual Boot Block

#### E.1 Introduction

This motherboard supports the Dual Boot Block feature, which is the last-ditch mechanism to recover the BIOS boot block. This section provides an introduction to the feature.

##### BIOS Boot Block

A BIOS boot block is the minimum BIOS loader required to enable necessary hardware components for the BIOS crisis recovery flash that will update the main BIOS block. An on-call BIOS boot-block corruption may occur due to a software tool issue (see image below) or an unexpected power outage during BIOS updates.

```
-----  
                AMI Firmware Update Utility vX.XX.XX  
        Copyright (C)XXXX American Megatrends Inc. All Rights Reserved.  
-----  
Reading flash . . . . . done  
-- ME Data Size checking . ok  
-- FFS checksums . . . . . ok  
Erasing Boot Block . . . . . done  
__ Updating Boot Block . . . . . 0x00A91000 (13%)
```

##### BIOS Boot Block Corruption Occurrence

When a BIOS boot block is corrupted due to an unexpected power outage or a software tool malfunctioning during BIOS updates, you can still reboot the system by closing pins 2 and 3 using a cap on jumper JBR1. When JBR1 is set to pins 2 and 3, the system will boot from a backup boot block pre-loaded in the BIOS by the manufacturer.

## **E.2 Steps to Reboot the System by Using Jumper JBR1**

1. Power down the system.
2. Close pins 2-3 on jumper JBR1, and power on the system.
3. Follow the BIOS recovery SOP listed in the previous chapter (Appendix D).
4. After completing the steps above, power down the system.
5. Close pins 1-2 on jumper JBR1, and power on the system.