

**SUPER**  <sup>®</sup>

**A1SA7-2750F/2550F**

**USER'S MANUAL**

Revision 1.0

---

---

The information in this user's manual has been carefully reviewed and is believed to be accurate. The vendor assumes no responsibility for any inaccuracies that may be contained in this document, and makes no commitment to update or to keep current the information in this manual, or to notify any person or organization of the updates. **Please Note: For the most up-to-date version of this manual, please see our website at [www.supermicro.com](http://www.supermicro.com).**

Super Micro Computer, Inc. ("Supermicro") reserves the right to make changes to the product described in this manual at any time and without notice. This product, including software and documentation, is the property of Supermicro and/or its licensors, and is supplied only under a license. Any use or reproduction of this product is not allowed, except as expressly permitted by the terms of said license.

IN NO EVENT WILL SUPER MICRO COMPUTER, INC. BE LIABLE FOR DIRECT, INDIRECT, SPECIAL, INCIDENTAL, SPECULATIVE OR CONSEQUENTIAL DAMAGES ARISING FROM THE USE OR INABILITY TO USE THIS PRODUCT OR DOCUMENTATION, EVEN IF ADVISED OF THE POSSIBILITY OF SUCH DAMAGES. IN PARTICULAR, SUPER MICRO COMPUTER, INC. SHALL NOT HAVE LIABILITY FOR ANY HARDWARE, SOFTWARE, OR DATA STORED OR USED WITH THE PRODUCT, INCLUDING THE COSTS OF REPAIRING, REPLACING, INTEGRATING, INSTALLING OR RECOVERING SUCH HARDWARE, SOFTWARE, OR DATA.

---

Any disputes arising between the manufacturer and the customer shall be governed by the laws of Santa Clara County in the State of California, USA. The State of California, County of Santa Clara shall be the exclusive venue for the resolution of any such disputes. Supermicro's total liability for all claims will not exceed the price paid for the hardware product.

---

FCC Statement: This equipment has been tested and found to comply with the limits for a Class A digital device pursuant to Part 15 of the FCC Rules. These limits are designed to provide reasonable protection against harmful interference when the equipment is operated in a commercial environment. This equipment generates, uses, and can radiate radio frequency energy and, if not installed and used in accordance with the manufacturer's instruction manual, may cause harmful interference with radio communications. Operation of this equipment in a residential area is likely to cause harmful interference, in which case you will be required to correct the interference at your own expense.

---

California Best Management Practices Regulations for Perchlorate Materials: This Perchlorate warning applies only to products containing CR (Manganese Dioxide) Lithium coin cells. "Perchlorate Material-special handling may apply. See [www.dtsc.ca.gov/hazardouswaste/perchlorate](http://www.dtsc.ca.gov/hazardouswaste/perchlorate)".

**WARNING**: Handling of lead solder materials used in this product may expose you to lead, a chemical known to the State of California to cause birth defects and other reproductive harm.

---

---

Manual Revision: 1.0

Release Date: June 26, 2014

Unless you request and receive written permission from Super Micro Computer, Inc., you may not copy any part of this document.

Information in this document is subject to change without notice. Other products and companies referred to herein are trademarks or registered trademarks of their respective companies or mark holders.

Copyright © 2014 by Super Micro Computer, Inc.  
All rights reserved.

**Printed in the United States of America**

## Preface

This manual is written for system integrators, IT technicians and knowledgeable end-users. It provides information for the installation and use of the **SUPER**® A1SA7-2750F/2550F Series motherboard.

### About This Motherboard

The **SUPER**® A1SA7-2750F/2550F motherboard supports a next-generation Intel® C2000 SoC (System-on-a-Chip) processor in an FCBGA package. With a C2000 Series processor built in, the A1SA7-2750F/2550F motherboard supports cutting-edge technology such as Intel's Virtualization Technology, Turbo Boost Technology, or Quickassist Technology, offering unprecedented enhancements to data integrity, internet security, network communication, system performance, and power efficiency and scalability. This motherboard is optimized for network applications, web hosting, storage/server applications, and cloud computing. It is ideal for communications systems, embedded solutions, or server or storage platforms. Please refer to our website at (<http://www.supermicro.com/products/>) for processor and memory support updates. This product is intended to be installed and serviced by professional technicians.

### Manual Organization

**Chapter 1** describes the features, specifications and performance of the motherboard, and provides detailed information on the Intel® C2000 Series processor.

**Chapter 2** provides hardware installation instructions. Read this chapter when installing the processor, memory modules and other hardware components into the system. If you encounter any problems, see **Chapter 3**, which describes troubleshooting procedures for video, memory and system setup stored in the CMOS.

**Chapter 4** includes an introduction to the BIOS, and provides detailed information on running the CMOS Setup utility.

**Appendix A** provides BIOS Error Beep Codes.

**Appendix B** lists software program installation instructions.

**Appendix C** contains UEFI BIOS Recovery instructions.

## Conventions Used in the Manual:

Special attention should be given to the following symbols for proper installation and to prevent damage done to the components or injury to yourself:

**Warning:** Critical information to prevent damage to the components or injury to yourself.



**Important:** Important information given to ensure proper system installation or to relay safety precautions.



**Note:** Additional Information given to differentiate various models or to provide instructions for correct system setup.

## Contacting Supermicro

### Headquarters

Address: Super Micro Computer, Inc.  
980 Rock Ave.  
San Jose, CA 95131 U.S.A.

Tel: +1 (408) 503-8000

Fax: +1 (408) 503-8008

Email: [marketing@supermicro.com](mailto:marketing@supermicro.com) (General Information)  
[support@supermicro.com](mailto:support@supermicro.com) (Technical Support)

Web Site: [www.supermicro.com](http://www.supermicro.com)

### Europe

Address: Super Micro Computer B.V.  
Het Sterrenbeeld 28, 5215 ML  
's-Hertogenbosch, The Netherlands

Tel: +31 (0) 73-6400390

Fax: +31 (0) 73-6416525

Email: [sales@supermicro.nl](mailto:sales@supermicro.nl) (General Information)  
[support@supermicro.nl](mailto:support@supermicro.nl) (Technical Support)  
[rma@supermicro.nl](mailto:rma@supermicro.nl) (Customer Support)

Web Site: [www.supermicro.nl](http://www.supermicro.nl)

### Asia-Pacific

Address: Super Micro Computer, Inc.  
3F, No. 150, Jian 1st Rd.  
Zhonghe Dist., New Taipei City 235  
Taiwan (R.O.C)

Tel: +886-(2) 8226-3990

Fax: +886-(2) 8226-3992

Email: [support@supermicro.com.tw](mailto:support@supermicro.com.tw)

Web Site: [www.supermicro.com.tw](http://www.supermicro.com.tw)

# Table of Contents

## **Preface**

### **Chapter 1 Introduction**

1-1	Overview .....	1-1
1-2	Processor Overview .....	1-10
1-3	Special Features .....	1-11
1-4	PC Health Monitoring .....	1-11
1-5	ACPI Features .....	1-12
1-6	Power Supply .....	1-12

### **Chapter 2 Installation**

2-1	Standardized Warning Statements .....	2-1
	Battery Handling .....	2-1
	Product Disposal .....	2-3
2-2	Static-Sensitive Devices .....	2-4
	Precautions .....	2-4
	Unpacking .....	2-4
2-3	Memory Support .....	2-5
	Memory Population Guidelines .....	2-5
	Populating Memory Modules .....	2-6
	Installing DIMM Memory Modules .....	2-6
	Removing Memory Modules .....	2-6
2-4	Motherboard Installation .....	2-8
	Tools Needed .....	2-8
	Location of Mounting Holes .....	2-8
	Installing the Motherboard .....	2-9
2-5	Connectors/IO Ports .....	2-10
	Backplane I/O Panel .....	2-10
	Serial Ports .....	2-11
	Ethernet Ports .....	2-11
	Universal Serial Bus (USB) .....	2-12
	Unit Identifier Switch .....	2-13
	VGA .....	2-13
	Front Control Panel .....	2-14
	Front Control Panel Pin Definitions .....	2-15
	NMI Button .....	2-15
	Power LED .....	2-15
	HDD LED .....	2-16
	NIC1/NIC2 (LAN1/LAN2) .....	2-16

---

	Overheat (OH)/Fan Fail/PWR Fail/UID LED .....	2-17
	Power Fail LED .....	2-17
	Reset Button .....	2-18
	Power Button .....	2-18
2-6	Connecting Cables .....	2-19
	Motherboard Power Input (JPWR1) .....	2-19
	4-pin Power Connector J3 .....	2-19
	Fan Headers (Fan 1 ~ Fan 7) .....	2-20
	Chassis Intrusion (JL1) .....	2-20
	Internal Buzzer (SP1) .....	2-21
	DOM PWR Connector (JSD1) .....	2-21
	TPM Header/Port 80 Header .....	2-22
	Overheat LED Header .....	2-22
	Power SMB (I <sup>2</sup> C) Connector .....	2-23
	System Management Bus Header .....	2-23
2-7	Jumper Settings .....	2-24
	Explanation of Jumpers .....	2-24
	LAN Ports Enable/Disable .....	2-24
	CMOS Clear .....	2-25
	PCI-E Slot SMB Enable (I <sup>2</sup> C1/I <sup>2</sup> C2) .....	2-25
	Watch Dog Timer Enable .....	2-26
	VGA Enable .....	2-26
2-8	Onboard Indicators .....	2-27
	GbE LAN LEDs .....	2-27
	IPMI Dedicated LAN LEDs .....	2-27
	LSI SAS2116 Hearbeat LED .....	2-28
	LSI SAS2116 Error LED .....	2-28
	Unit Identification LED .....	2-29
	Overheat/PWR Fail/Fan Fail LED .....	2-29
2-9	SATA Connections .....	2-30
	SATA Ports .....	2-30
 <b>Chapter 3 Troubleshooting</b>		
3-1	Troubleshooting Procedures .....	3-1
3-2	Technical Support Procedures .....	3-2
3-3	Frequently Asked Questions .....	3-4
3-4	Battery Removal and Installation .....	3-5
3-5	Returning Merchandise for Service .....	3-6

**Chapter 4 BIOS**

4-1	Introduction.....	4-1
4-2	Main Setup.....	4-2
4-3	Advanced Setup Configurations.....	4-4
4-4	IPMI.....	4-26
4-5	Event Logs.....	4-28
4-6	Boot.....	4-30
4-7	Security.....	4-31
4-8	Save & Exit.....	4-35

**Appendix A BIOS Error Beep Codes**

A-1	BIOS Error Beep Codes.....	A-1
-----	----------------------------	-----

**Appendix B Software Installation Instructions**

B-1	Installing Software Programs.....	B-1
B-2	Installing SuperDoctor® 5.....	B-2

**Appendix C UEFI BIOS Recovery Instructions**

C-1	An Overview to the UEFI BIOS.....	C-1
C-2	How to Recover the UEFI BIOS Image (-the Main BIOS Block).....	C-1
C-3	To Recover the Main BIOS Block Using a USB-Attached Device.....	C-1



# Chapter 1

## Introduction

### 1-1 Overview

#### Checklist

Congratulations on purchasing your computer motherboard from an acknowledged leader in the industry. Supermicro boards are designed with the utmost attention to detail to provide you with the highest standards in quality and performance.

Please check that the following items have all been included with your motherboard. If anything listed here is damaged or missing, contact your retailer.

The following items are included in the retail box.

- One (1) Supermicro Motherboard
- Sixteen (16) SAS cables



**Note:** For your system to work properly, please follow the links below to download all necessary drivers/utilities and the user's manual for your motherboard.

SMCI product manuals: <http://www.supermicro.com/support/manuals/>

Product Drivers and utilities: <ftp://ftp.supermicro.com/>

If you have any questions, please contact our support team at [support@supermicro.com](mailto:support@supermicro.com).

SUPER® A1SA7-2750F/2550F Motherboard Image

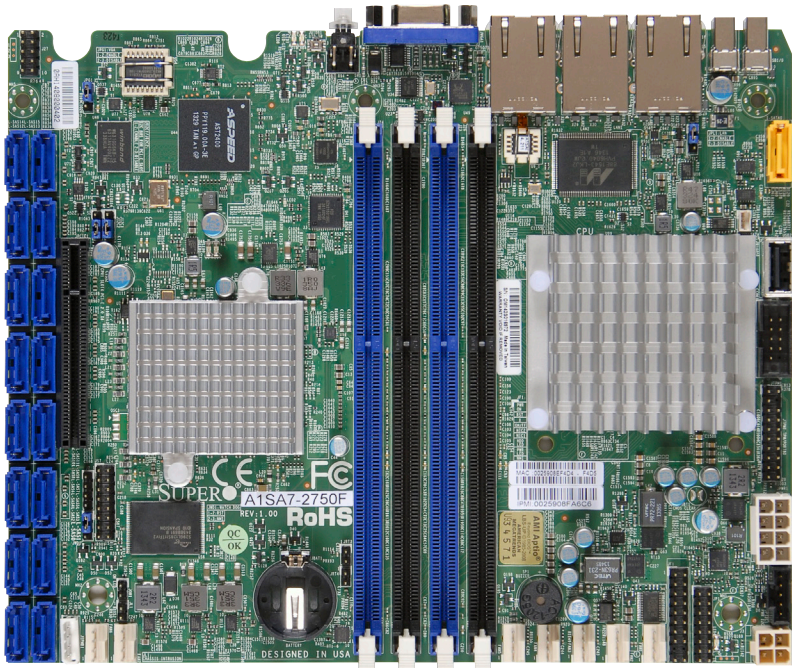

 **Note:** All graphics shown in this manual were based upon the latest PCB Revision available at the time of publishing of the manual. The motherboard you've received may or may not look exactly the same as the graphics shown in this manual.

## A1SA7-2750F/2550F Motherboard Layout

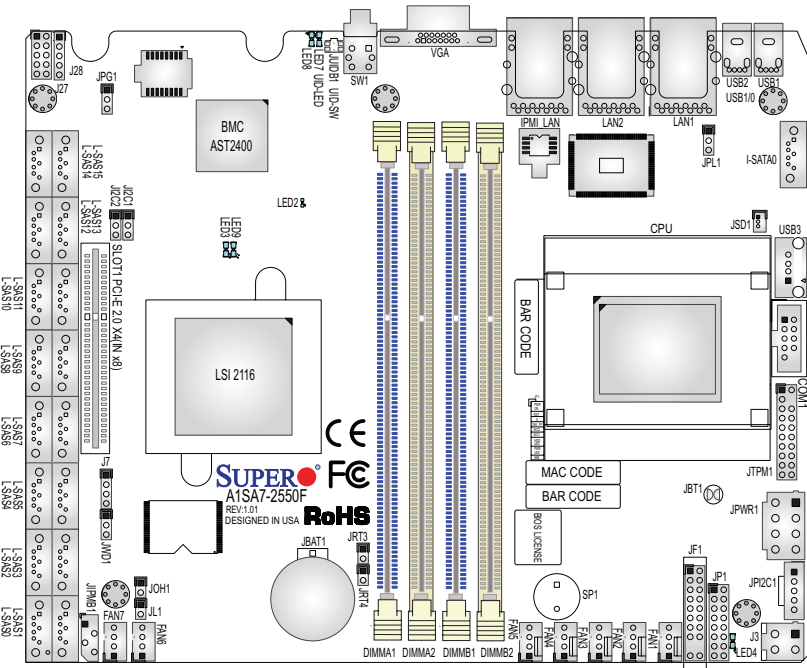

### Important Notes to the User

1. See Chapter 2 for detailed information on jumpers, I/O ports and JF1 front panel connections.
2. "■" indicates the location of "Pin 1". Jumpers not indicated are for testing only.
3. When LED3 (Onboard Power LED Indicator) is on, system power is on. Unplug the power cable before installing or removing any components.
4. The A1SA7-2750F/2550F motherboard supports Turbo Boost Technology, offering turbo-boost capabilities to maximize system performance for server platforms.

A1SA7-2750F/2550F Motherboard Quick Reference

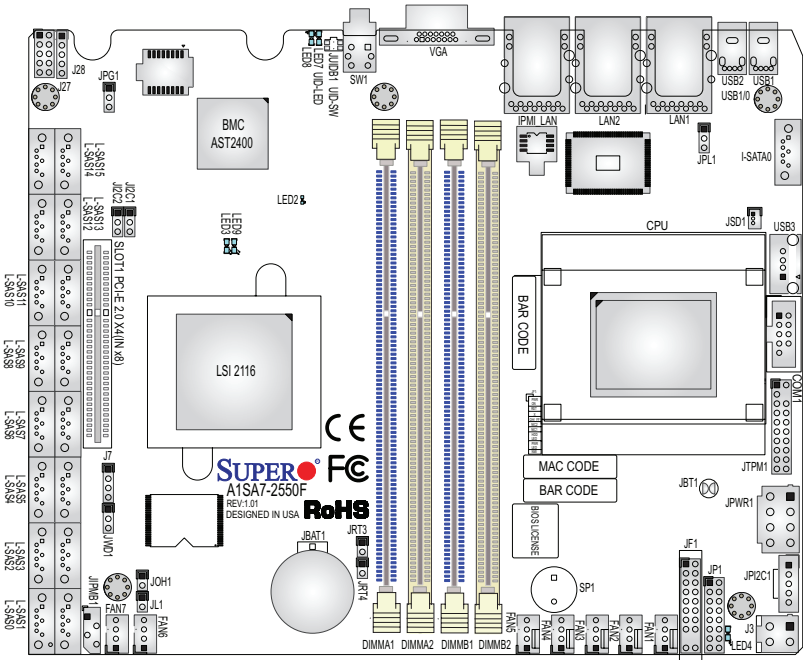

A1SA7-2750F/2550F Motherboard Jumpers		
Jumper	Description	Default
JBT1	CMOS Clear	Open: Normal, Short: Clear CMOS
J1C1/J1C2	SMB to PCI-Exp. Slots	Off (Disabled)
JPG1	VGA Enable	Pins 1-2 (Enabled)
JPL1	Ethernet LAN Ports Enable	Pins 1-2 (Enabled)
JWD1	Watch Dog Enable	Pins 1-2 (Reset)

<b>A1SA7-2750F/2550F Motherboard Headers/Connectors</b>	
<b>Connector</b>	<b>Description</b>
Battery (JBAT1)	Onboard Battery
COM1	COM1 Header
FAN1-FAN7	CPU/System Cooling Fans
IPMI_LAN	IPMI_Dedicated LAN
J3	Motherboard 5V Standby Power Input
J27	NC-SI Header for AOC-STGN-i1SF 10GbE Card
J28	Power to AOC-STGN-i1SF Card
JF1	Front Panel Control Header
JIPMB1	4-pin External SMBus I <sup>2</sup> C Header
JL1	Chassis Intrusion Header
JOH1	Overheat/Fan Fail LED Header
JP1	HDD BackPlane Power Control header
JPI <sup>2</sup> C1	Power Supply System Management Bus (SMBus) I <sup>2</sup> C Header
JPWR1	+12V 8-pin Motherboard Power Input Connector
JSD1	SATA DOM (Device_On_Module) Power Connector
JTPM1	Trusted Platform Module (TPM)/Port 80 Connector
JUIDB1	Unit Identifier (UID) Button
LAN1/LAN2	Gigabit Ethernet (RJ45) Ports
L-SAS0 - L-SAS15 I-SATA0	LSI 2116 SAS Ports 0-15 Intel Serial ATA Port 0
PCI-E Slot	PCI-E Slot 2.0 x4 (x8)
SP1	Internal Speaker/Buzzer
SW1	Power button
USB1/USB2	Backpanel USB 2.0 Ports 1/2
USB 3	Front Access USB 2.0 Port 3 (Type A Connector)
VGA	Backpanel VGA Port

**A1SA7-2750F/2550F Motherboard LED Indicators**

<b>LED</b>	<b>Description</b>	<b>Color/State</b>	<b>Status</b>
LED2	BMC Heartbeat LED	Green: Blinking	BMC: Normal
LED3	LSISAS2116 Heartbeat LED	Green: Blinking	SAS Controller: Normal
LED4	Power LED	Green: On	System Power On
LED7	UID Switch LED	Blue: On	Unit Identified
LED8	Overheat/PWR Fail/Fan Fail LED	Red: Solid on/Blinking	Solid On: Overheat, Blinking: PWR Fail or Fan Fail
LED9	LSISAS2116 Error LED	Red: On	LSISAS2116 Error Status

## Motherboard Features

<b>CPU</b>	Single Intel® C2000 Tri-Gate 22nm SoC in the FCBGA 1283 package	
	2.4 GHz C2750 (8 Core) or C2550 (4 Core). formerly Avoton Atom processor	
<b>Memory</b>	Four (4) memory slots support up to 64 GB of DDR3 Unbuffered (UDIMM) ECC or Non-ECC 1600/1333 MHz (1.5V, 1.35V) memory.	
	<b>Note:</b> Please populate identical memory modules (of the same type/sspeed/size) in all slots.	
	Dual-Channel memory or Single-Channel w/x8 data width, Single or Dual Rank memory	
	<b>DIMM sizes</b>	
	DIMMs	2 GB, 4GB, 8GB, and 16GB
<b>Expansion Slot</b>	One (1) PCI Express 2.0 x4 in x8 slot	
<b>Network Connections</b>	Dual GbE I354 controller	
	Two (2) RJ-45 rear I/O panel connectors with Link and Activity LEDs	
	One (1) IPMI LAN Connector (Realtek 8211E-PHY)	
<b>I/O Devices</b>	<b>SAS/SATA Connections</b>	
	SAS 2.0 (3Gb/s)	Sixteen (16) SAS 2.0 (L-SAS0-15)
	SATA 3.0 (6Gb/s)	One (1) SATA 3.0 (I-SATA0)
	<b>USB Devices</b>	
	Two (2) USB 2.0 ports on the I/O backplane	
	One (1) USB 2.0 Type A Header	
	<b>Serial (COM) Ports</b>	
	One (1) Serial Header	
	<b>IPMI 2.0</b>	
	IPMI 2.0 supported by Aspeed AST2400 BMC (Base-board Management Controller)	
	<b>VGA (Graphics Display)</b>	
	One (1) VGA Port on the rear I/O panel supported by the Aspeed AST2400 VGA Controller	
<b>BIOS</b>	64 Mb AMI BIOS® SPI EEPROM BIOS	
	Plug and Play, DMI 2.0, PCI 2.3, ACPI 5.0, USB Keyboard, SMBIOS 2.7, and UEFI 2.3.1	

<b>Power Configuration</b>	ACPI/ACPM Power Management (S0, S5 only)
	Main Switch Override Mechanism
	Power-on mode for AC power recovery
<b>PC Health Monitoring</b>	<b>Onboard Voltage Monitoring</b>
	+3.3V, +5V,+12V, VBAT, VDIMM, VCORE for CPU
	CPU 1+1-phase switching voltage regulator
	CPU/System overheat LED and control
	CPU Thermal Trip support
	SoC Thermal Control Circuit (TCC) mechanism
	Thermal Monitor Support
	<b>Fan Control</b>
	Low noise fan speed control
	<b>BMC Health Monitoring</b>
	BMC Fan control and thermal alert by sensors monitoring, including CPU, memory and motherboard ambient temperatures
	<b>System Management</b>
System resource alert via SuperDoctor® 5	
SuperDoctor® 5, Watch Dog, NMI	
Chassis Intrusion header and detection	
<b>CD Utilities</b>	Download from <a href="http://www.supermicro.com">www.supermicro.com</a>
<b>Other</b>	Optional 10 GbE SPF + AOC-STGN-i1SF add-on card with NC-SI support
	ROHS (Full Compliance, Lead Free)
	Operating Temperature 0°-50°C
<b>Dimensions</b>	Proprietary (8.3" x 6.7") (21.08cm x 17.02cm)



## A1SA7-2750F/2550F Motherboard Block Diagram

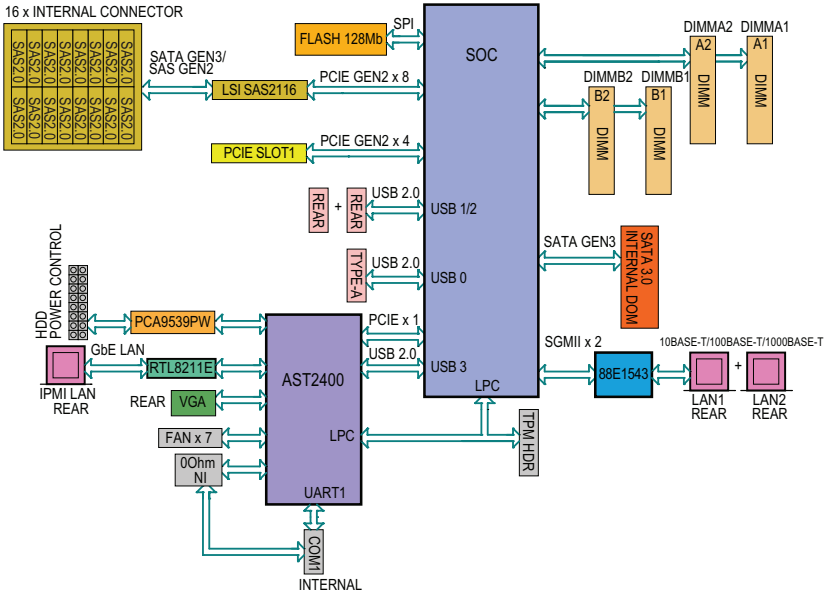

## System Block Diagram



**Note:** This is a general block diagram and may not exactly represent the features on your motherboard. See the Motherboard Features pages for the actual specifications of each motherboard.

## 1-2 Processor Overview

The A1SA7-2750F/2550F motherboard supports a 2nd-generation 64-bit, Intel<sup>®</sup> Atom™ C2000 Tri-Gate SoC (System-on-a-Chip) processor based on low-power Silvermont microarchitecture in an FCBGA 1283 package. Built upon the functionality and capability of the C2000 Series processor in the low-power 22nm microarchitecture, the A1SA7-2750F/2550F motherboard provides unprecedented enhancements to network routing, internet security, system performance, and power efficiency.

The C2000 SoC Series processor features an Out-of-Order Execution Engine and offers new multi-core and system fabric architecture capable of utilizing eight CPU cores to achieve improved single-thread performance. This new SoC processor also provides an operating range with wider dynamic power and enhanced power management. The A1SA7-2750F/2550F motherboard also supports the Intel<sup>®</sup> Turbo Boost Technology, which offers turbo-boost capabilities to maximize system performance.

### ***Intel C2000 Series Processor Features***

The C2000 Series processor offers the following features:

- SSE Extensions
- AES-NI
- Highly-Optimized Power Management Unit
- Server-Class Reliability, Availability and Serviceability (RAS)
- Intel<sup>®</sup> Virtualization Technology (VTx)
- Intel<sup>®</sup> Turbo Boost Technology

## 1-3 Special Features

### Recovery from AC Power Loss

Basic I/O System (BIOS) provides a setting for you to determine how the system will respond when AC power is lost and then restored to the system. You can choose for the system to remain powered off, (in which case you must press the power switch to turn it back on), or for it to automatically return to a power-on state. See the Advanced BIOS Setup section to change this setting. The default setting is **Last State**.

## 1-4 PC Health Monitoring

This section describes the PC health monitoring features of the board. All have an onboard System Hardware Monitoring chip that supports PC health monitoring. An onboard voltage monitor will scan these onboard voltages continuously: CPU Vcore, VTT\_CPU, VDIMM, 12V, 5V, 3.3V, 3.3V Standby, and Battery voltages. Once a voltage becomes unstable, a warning is given, or an error message is sent to the screen. The user can adjust the voltage thresholds to define the sensitivity of the voltage monitor.

### Environmental Temperature Control

This motherboard came with a passive heatsink built in. Please follow the instructions given in your system design guide or your system user manual to provide adequate airflow to your system. The onboard BaseBoard Management Controller (BMC) monitors CPU, memory and motherboard environment temperatures for fan control and PC health management.



**Note:** To avoid possible system overheating, please be sure to provide adequate airflow to your system.

### System Resource Alert

This feature is available when the system is used with SuperDoctor® 5 in the Windows and Linux operating systems. SuperDoctor is used to notify the user of certain system events. For example, you can also configure SuperDoctor to provide you with warnings when the system temperature, CPU temperatures, voltages and fan speeds go beyond predefined thresholds.

## 1-5 ACPI Features

ACPI stands for Advanced Configuration and Power Interface. The ACPI specification defines a flexible and abstract hardware interface that provides a standard way to integrate power management features throughout a PC system, including its hardware, operating system and application software. This enables the system to automatically turn on and off peripherals such as CD-ROMs, network cards, hard disk drives and printers.

In addition to enabling operating system-directed power management, ACPI also provides a generic system event mechanism for Plug and Play, and an operating system-independent interface for configuration control. ACPI leverages the Plug and Play BIOS data structures, while providing a processor architecture-independent implementation that is compatible with Windows 7, Windows 8, and Windows 2008 operating Systems.



**Note:** A1SAM/A1SRM Series motherboards support S0 and S5 only.

## 1-6 Power Supply

This A1SA7 requires a proprietary power supply with 12V input source from the JPWR1 connector and 5V standby power source from the J3 connector. We strongly recommend the user buy the complete system (SSG-5018A-AR12L) for proper operation with this motherboard.

---

---

## Chapter 2

### Installation

#### 2-1 Standardized Warning Statements

The following statements are industry-standard warnings, provided to warn the user of situations which have the potential for bodily injury. Should you have questions or experience difficulty, contact Supermicro's Technical Support department for assistance. Only certified technicians should attempt to install or configure components. Read this section in its entirety before installing or configuring components in the Supermicro chassis.

#### Battery Handling



##### Warning!

There is a danger of explosion if the battery is replaced incorrectly. Replace the battery only with the same or equivalent type recommended by the manufacturer. Dispose of used batteries according to the manufacturer's instructions

##### 電池の取り扱い

電池交換が正しく行われなかった場合、破裂の危険性があります。交換する電池はメーカーが推奨する型、または同等のものを使用下さい。使用済電池は製造元の指示に従って処分して下さい。

##### 警告

電池更換不當會有爆炸危險。請只使用同類電池或制造商推薦的功能相當的電池更換原有電池。請按製造商的說明處理廢舊電池。

##### 警告

電池更換不當會有爆炸危險。請使用製造商建議之相同或功能相當的電池更換原有電池。請按照製造商的說明指示處理廢棄舊電池。

##### Warnung

Bei Einsetzen einer falschen Batterie besteht Explosionsgefahr. Ersetzen Sie die Batterie nur durch den gleichen oder vom Hersteller empfohlenen Batterietyp. Entsorgen Sie die benutzten Batterien nach den Anweisungen des Herstellers.

Attention

Danger d'explosion si la pile n'est pas remplacée correctement. Ne la remplacer que par une pile de type semblable ou équivalent, recommandée par le fabricant. Jeter les piles usagées conformément aux instructions du fabricant.

¡Advertencia!

Existe peligro de explosión si la batería se reemplaza de manera incorrecta. Reemplazar la batería exclusivamente con el mismo tipo o el equivalente recomendado por el fabricante. Desechar las baterías gastadas según las instrucciones del fabricante.

**אזהרה!**

קיימת סכנת פיצוץ של הסוללה במידה והוחלפה בדרך לא תקינה. יש להחליף את הסוללה בסוג התואם מחברת יצרן מומלצת.

סילוק הסוללות המשומשות יש לבצע לפי הוראות היצרן.

هناك خطر من انفجار في حالة استبدال البطارية بطريقة غير صحيحة فعليك استبدال البطارية فقط بنفس النوع أو ما يعادلها كما أوصت به الشركة المصنعة تخلص من البطاريات المستعملة وفقا لتعليمات الشركة الصانعة

경고!

배터리가 올바르게 교체되지 않으면 폭발의 위험이 있습니다. 기존 배터리와 동일하거나 제조사에서 권장하는 동등한 종류의 배터리로만 교체해야 합니다. 제조사의 안내에 따라 사용된 배터리를 처리하여 주십시오.

Waarschuwing

Er is ontploffingsgevaar indien de batterij verkeerd vervangen wordt. Vervang de batterij slechts met hetzelfde of een equivalent type die door de fabrikant aanbevolen wordt. Gebruikte batterijen dienen overeenkomstig fabrieksvoorschriften afgevoerd te worden.

---

---

## Product Disposal



### Warning!

Ultimate disposal of this product should be handled according to all national laws and regulations.

### 製品の廃棄

この製品を廃棄処分する場合、国の関係する全ての法律・条例に従い処理する必要があります。

### 警告

本产品的废弃处理应根据所有国家的法律和规章进行。

### 警告

本產品的廢棄處理應根據所有國家的法律和規章進行。

### Warnung

Die Entsorgung dieses Produkts sollte gemäß allen Bestimmungen und Gesetzen des Landes erfolgen.

### ¡Advertencia!

Al deshacerse por completo de este producto debe seguir todas las leyes y reglamentos nacionales.

### Attention

La mise au rebut ou le recyclage de ce produit sont généralement soumis à des lois et/ou directives de respect de l'environnement. Renseignez-vous auprès de l'organisme compétent.

## סילוק המוצר

### אזהרה!

סילוק סופי של מוצר זה חייב להיות בהתאם להנחיות וחוקי המדינה.

عند التخلص النهائي من هذا المنتج ينبغي التعامل معه وفقا لجميع القوانين واللوائح الوطنية

경고!

이 제품은 해당 국가의 관련 법규 및 규정에 따라 폐기되어야 합니다.

Waarschuwing

De uiteindelijke verwijdering van dit product dient te geschieden in overeenstemming met alle nationale wetten en reglementen.

## 2-2 Static-Sensitive Devices

Electrostatic-Discharge (ESD) can damage electronic components. To avoid damaging your system board, it is important to handle it very carefully. The following measures are generally sufficient to protect your equipment from ESD.

### Precautions

- Use a grounded wrist strap designed to prevent static discharge.
- Touch a grounded metal object before removing the board from the antistatic bag.
- Handle the board by its edges only; do not touch its components, peripheral chips, memory modules or gold contacts.
- When handling chips or modules, avoid touching their pins.
- Put the motherboard and peripherals back into their antistatic bags when not in use.
- For grounding purposes, make sure your computer chassis provides excellent conductivity between the power supply, the case, the mounting fasteners and the motherboard.
- Use only the correct type of onboard CMOS battery. Do not install the onboard battery upside down to avoid possible explosion.

### Unpacking

The motherboard is shipped in antistatic packaging to avoid static damage. When unpacking the board, make sure that the person handling it is static protected.



## 2-3 Memory Support

The A1SA7-2750F/2550F motherboard supports up to 64 GB of DDR3 ECC or Non-ECC Unbuffered UDIMM 1600/1333 MHz in four memory slots. Populating these DIMM slots with a pair of memory modules of the same type and size will result in better memory performance.

 **Note 1:** Check the Supermicro website for recommended memory modules.

 **Note 2:** Be sure to use memory modules of the same type, speed, and size on the motherboard. Mixing of memory modules of different types and speeds is not allowed.

### CAUTION

Exercise extreme care when installing or removing DIMM modules to prevent any possible damage.

### Memory Population Guidelines

Please follow the table below when populating the motherboard.

Unbuffered DDR3 ECC DIMM Memory				
DIMM Slots per Channel	DIMMs Populated per Channel	DIMM Type	POR Speeds	Memory Population Sequence
2	1	Unbuffered DDR3 DIMM	1600,1333	A1, B1 (2 DIMMs)
2	2	Unbuffered DDR3 DIMM	1600,1333	A1, B1, A2, B2 (4 DIMMs)

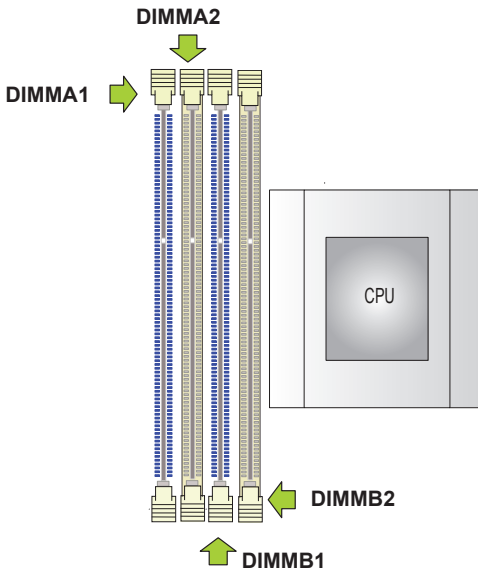

## Populating Memory Modules

**Note 1:** Install the desired number of DIMMs into the memory slots, starting with DIMMA1, then DIMMB1, then DIMMA2, then DIMMB2. Pay attention to the notch along the bottom of the module to prevent incorrect DIMM module installation.

**Note 2:** Insert each DIMM module vertically and snap it into place. Repeat step 1 until you complete the memory installation. See the section below for more details on DIMM memory installation.

**Note 3:** Insert only identical DIMM modules of the same part number into the memory slots to ensure that only memory modules of the same type, same speed, and same capacity are used on the same motherboard.

## Installing DIMM Memory Modules

1. Align the key on the bottom of the DIMM module against the receptive point on the memory slot. Take note of the notches on the side of the DIMM module, and of the locking clips on the socket to avoid causing damage.

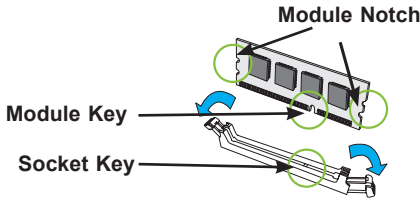

2. Install the DIMM module straight down into the socket until it is securely seated in the socket. The side clips will automatically lock the module into place.



## Removing Memory Modules

Use your thumbs to gently push the side clips near both ends away from the module to release it from the socket. Once the module is loosened from the socket, pull the DIMMs module upwards.

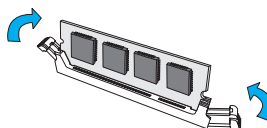



**Note:** Due to memory allocation to system devices, the amount of memory that remains available for operational use will be reduced when 4 GB of RAM is used. The reduction in memory availability is disproportional. See the following table for details.

<b>Possible System Memory Allocation &amp; Availability</b>		
<b>System Device</b>	<b>Size</b>	<b>Physical Memory Remaining (-Available) (4 GB Total System Memory)</b>
Firmware Hub flash memory (System BIOS)	1 MB	3.99
Local APIC	4 KB	3.99
Area Reserved for the chipset	2 MB	3.99
I/O APIC (4 Kbytes)	4 KB	3.99
PCI Enumeration Area 1	256 MB	3.76
PCI Express (256 MB)	256 MB	3.51
PCI Enumeration Area 2 (if needed) -Aligned on 256-MB boundary-	512 MB	3.01
VGA Memory	16 MB	2.85
TSEG	1 MB	2.84
Memory available to OS and other applications		2.84

## 2-4 Motherboard Installation

The A1SA7 is designed to work with the Supermicro proprietary chassis with a non-standard mounting hole layout. Make sure that the locations of all the mounting holes for both motherboard and chassis match. Although a chassis may have both plastic and metal mounting fasteners, metal ones are highly recommended because they ground the motherboard to the chassis. Make sure that the metal standoffs click in or are screwed in tightly. Then use a screwdriver to secure the motherboard onto the motherboard tray.



Philips Screwdriver  
(1)



Philips Screws (5)



Standoffs (5)  
Only if Needed

### Tools Needed

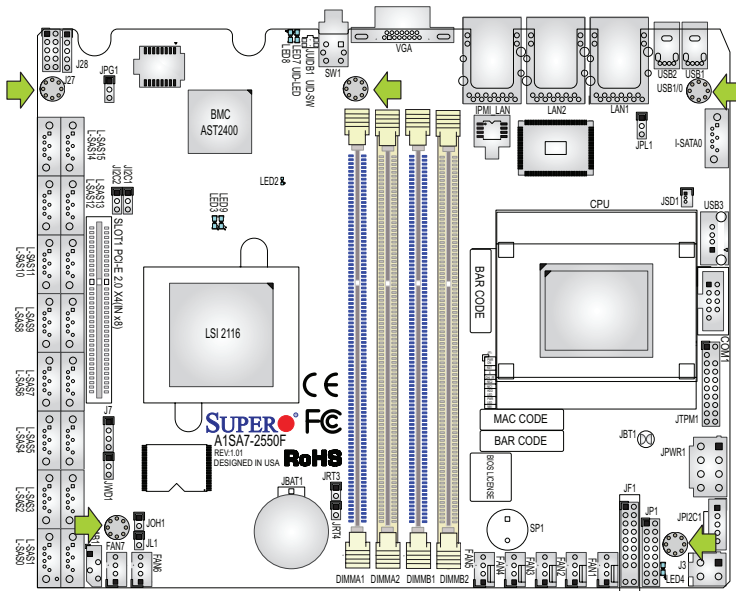

### Location of Mounting Holes

**Caution:** 1) To avoid damaging the motherboard and its components, please do not use a force greater than 8 lb/inch on each mounting screw during motherboard installation. 2) Some components are very close to the mounting holes. Please take precautionary measures to avoid damaging these components when installing the motherboard to the chassis.

## Installing the Motherboard

1. A1SA7 motherboard does not ship with an I/O shield since it is designed for the Supermicro proprietary 1U chassis CSE-801LTQ-R406B only.

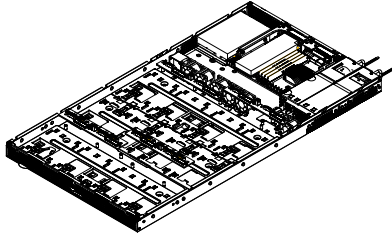

2. Locate the mounting holes on the motherboard. (See the previous page.)
3. Locate the matching mounting holes on the chassis. Align the mounting holes on the motherboard against the mounting holes on the chassis.
4. Install standoffs in the chassis as needed.

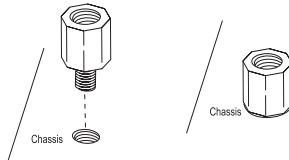

5. Install the motherboard into the chassis carefully to avoid damaging other motherboard components.
6. Using the Phillips screwdriver, insert a Phillips head #6 screw into a mounting hole on the motherboard and its matching mounting hole on the chassis.

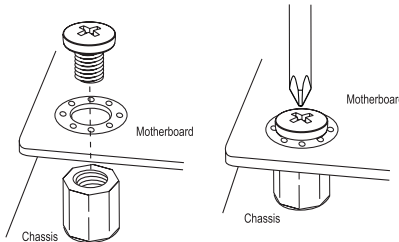

7. Repeat Step 5 to insert #6 screws into all mounting holes.
8. Make sure that the motherboard is securely placed in the chassis.

 **Note:** Images displayed are for illustration only. Your chassis or components might look different from those shown in this manual.

## 2-5 Connectors/I/O Ports

The I/O ports are color coded in conformance with the industry standards. See the figure below for the colors and locations of the various I/O ports.

### Backplane I/O Panel

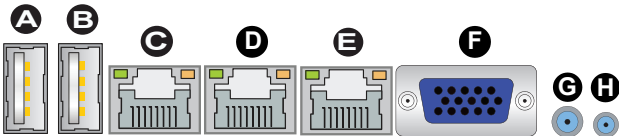
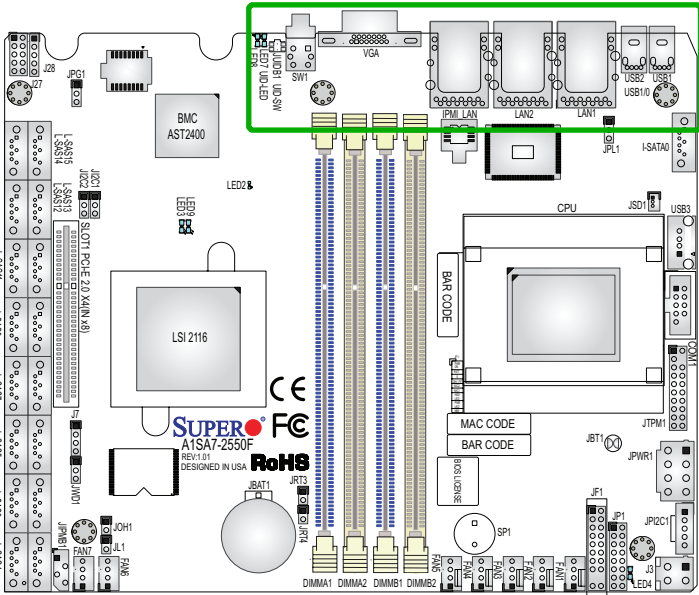

Backplane I/O Panel	
A. USB Port 1	E. IPMI LAN
B. USB Port 2	F. VGA
C. LAN Port 1	G. Power Button
D. LAN Port 2	H. UID Switch

### Serial Ports

COM1 port is located next to the CPU to provide a serial port connection. See the table on the right for pin definitions.

Serial COM) Ports Pin Definitions			
Pin #	Definition	Pin #	Definition
1	DCD	6	DSR
2	RXD	7	RTS
3	TXD	8	CTS
4	DTR	9	RI
5	Ground	10	N/A

### Ethernet Ports

Two Gigabit Ethernet ports (LAN1/2) are located next to the VGA Connector on the I/O backpanel to provide network connections. In addition, an IPMI\_Dedicated LAN, supported by the BMC controller, is also located on the I/O Panel. These ports accept RJ45 type cables.

**Note:** Please refer to the LED Indicator Section for LAN LED information.

LAN Ports Pin Definition			
Pin#	Definition	Pin#	Definition
1	P2V5SB	10	SGND
2	TD0+	11	Act LED
3	TD0-	12	P3V3SB
4	TD1+	13	Link 100 LED (Green, +3V3SB)
5	TD1-	14	Link 1000 LED (Yellow, +3V3SB)
6	TD2+	15	Ground
7	TD2-	16	Ground
8	TD3+	17	Ground
9	TD3-	88	Ground

(NC: No Connection)

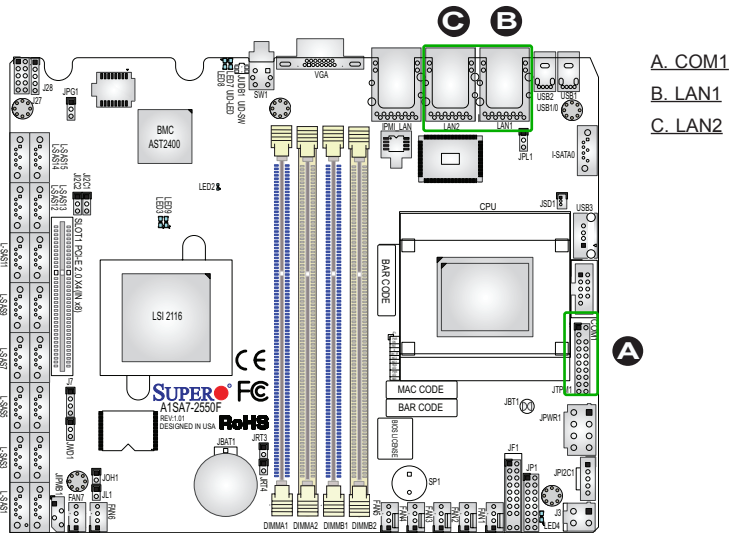

**Universal Serial Bus (USB)**

Two Universal Serial Bus 2.0 ports are located on the I/O backplane. USB 2.0 port 3 is a Type A connector. (USB cables are not included in the shipment.) See the tables below for pin definitions.

Back Panel USB #1/2 Pin Definitions			
Pin#	Definition	Pin#	Definition
1	+5V	5	+5V
2	USB_PN1	6	USB_PN0
3	USB_PP1	7	USB_PP0
4	Ground	8	Ground

Internal USB #3 Pin Definitions		
Pin#	Signal	Description
1	VBus	Power
2	IntA_P1_SSRX-	USB3 ICC Port1 SuperSpeed Rx-
3	IntA_P1_SSRX+	USB3 ICC Port1 SuperSpeed Rx+
4	Ground	Ground
5	IntA_P1_SSTX-	USB3 ICC Port1 SuperSpeed Tx-
6	IntA_P1_SSTX+	USB3 ICC Port1 SuperSpeed Tx+
7	Ground	Ground
8	IntA_P1_D-	USB3 ICC Port1 D- (USB2 Signal D-)
9	IntA_P1_D+	USB3 ICC Port1 D+ (USB2 Signal D2+)
10	Ground	Ground
11-19	NC (Not Connected)	NC (Not Connected)

A. Backpanel USB 2.0 #1

B. Backpanel USB 2.0 #2

C. Front Access USB 2.0 #3

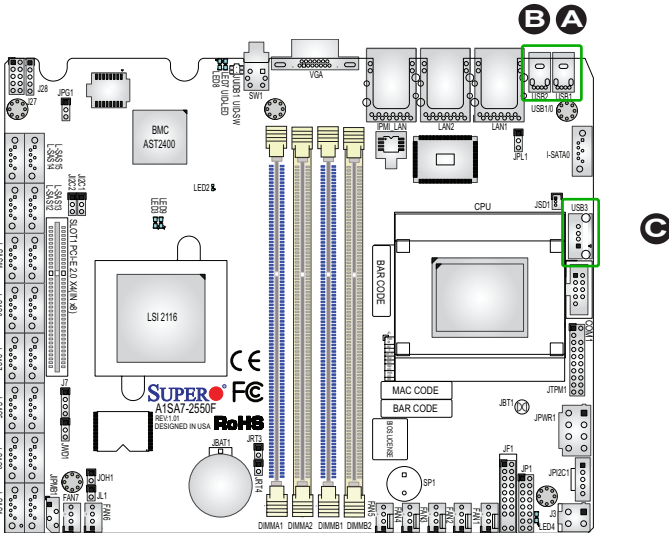



### Unit Identifier Switch

A Unit Identifier (UID) Switch and two LED indicators are located on the motherboard. The UID Switch is located next to the VGA port on the backplane. The Rear UID LED (LED7) is located next to the UID Switch. The Front Panel UID LED is located at Pin 7 of the Front Control Panel at JF1. Connect a cable to Pin 7 on JF1 for Front Panel UID LED indication. When you press the UID switch, both Rear UID LED and Front Panel UID LED Indicators will be turned on. Press the UID switch again to turn off both LED Indicators. These UID Indicators provide easy identification of a system unit that may be in need of service.

UID Switch	
Pin#	Definition
1	Ground
2	Ground
3	Button In
4	Ground

UID LED Status		
Color/State	OS	Status
Blue: On	Windows OS	Unit Identified
Blue: Blinking	Linux OS	Unit Identified

**Note:** UID can also be triggered via IPMI on the motherboard. For more information on IPMI, please refer to the IPMI User's Guide posted on our website @ <http://www.supermicro.com>.

### VGA

A VGA port is located next to the IPMI\_LAN port on the I/O backpanel. Use this port to connect to a compatible VGA display.

- A. UID Switch
- B. Rear UID LED
- C. Front UID LED
- D. VGA

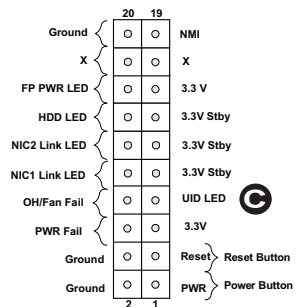
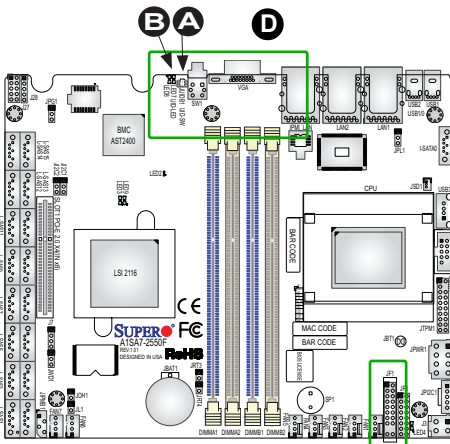

## Front Control Panel

JF1 contains header pins for various buttons and indicators that are normally located on a control panel at the front of the chassis. These connectors are designed specifically for use with Supermicro chassis. See the figure below for the descriptions of the front control panel buttons and LED indicators. Refer to the following section for descriptions and pin definitions.

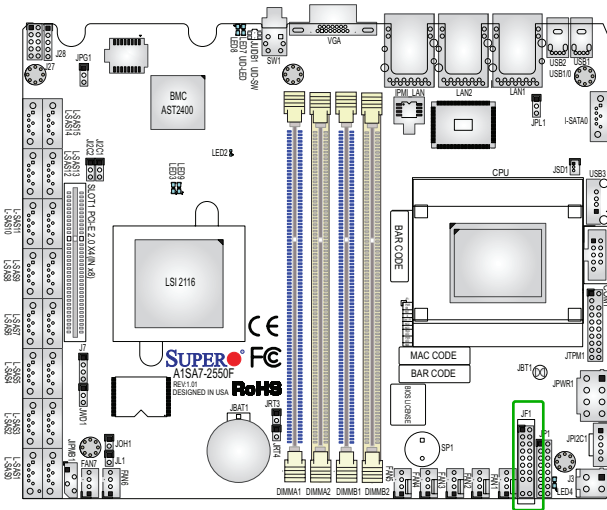

### JF1 Header Pins

	20	19	
Ground	○	○	NMI
X	○	○	X
FP PWR LED	○	○	3.3 V
HDD LED	○	○	3.3V Stby
NIC2 Link LED	○	○	3.3V Stby
NIC1 Link LED	○	○	3.3V Stby
OH/Fan Fail	○	○	UID LED
PWR Fail	○	○	3.3V
Ground	○	○	Reset } Reset Button
Ground	○	○	PWR } Power Button
	2	1	

## Front Control Panel Pin Definitions

### NMI Button

The non-maskable interrupt button header is located on pins 19 and 20 of JF1. Refer to the table on the right for pin definitions.

NMI Button Pin Definitions (JF1)	
Pin#	Definition
19	Control
20	Ground

### Power LED

The Power LED connection is located on pins 15 and 16 of JF1. Refer to the table on the right for pin definitions.

Power LED Pin Definitions (JF1)	
Pin#	Definition
15	3.3V
16	PWR LED

A. NMI Button

B. PWR LED

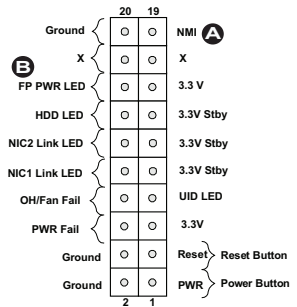
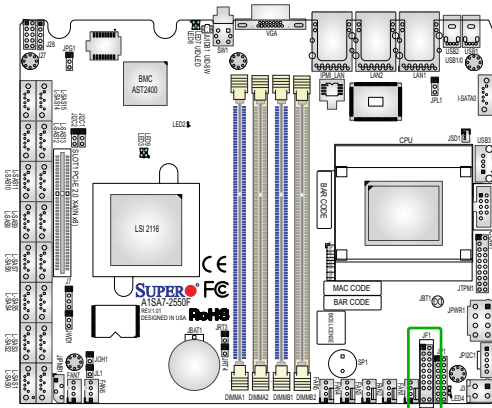

**HDD LED**

The HDD LED connection is located on pins 13 and 14 of JF1. Attach a cable here to indicate the status of HDD-related activities, including IDE, SATA activities. See the table on the right for pin definitions.

HDD LED Pin Definitions (JF1)	
Pin#	Definition
13	3.3V Standby
14	HD LED

**NIC1/NIC2 (LAN1/LAN2)**

The NIC (Network Interface Controller) LED connection for LAN port 1 is located on pins 11 and 12 of JF1, and the LED connection for LAN Port 2 is on Pins 9 and 10. NIC1 LED and NIC2 LED are 2-pin NIC LED headers. Attach NIC LED cables to NIC1 and NIC2 LED indicators to display network activities. Refer to the table on the right for pin definitions.

LAN1/LAN2 LED Pin Definitions (JF1)	
Pin#	Definition
9/11	3.3V Standby
10/12	NIC Link LED

- A. HDD LED
- B. NIC1 LED
- C. NIC2 LED

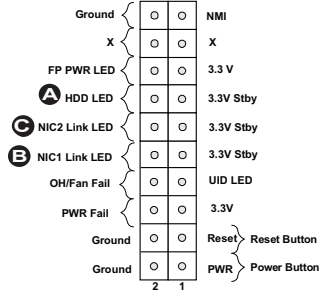
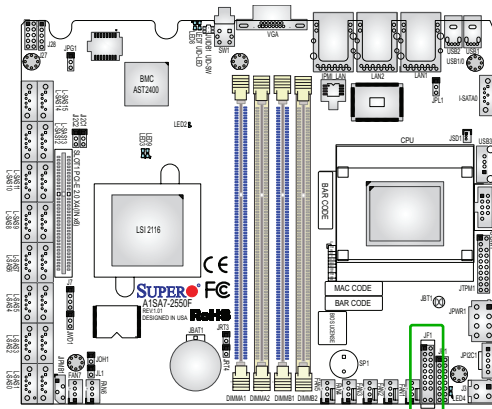

**Overheat (OH)/Fan Fail/PWR Fail/UID LED**

Connect an LED cable to pins 7 and 8 of Front Control Panel to use the Overheat/Fan Fail/Power Fail and UID LED connections. The blue LED on pin 7 works as the front panel UID LED indicator. The red LED on pin 8 works provides warnings of overheat, fan failure or power failure. The red LED takes precedence over the blue LED by default. Refer to the table on the right for pin definitions.

OH/Fan Fail/ PWR Fail/Blue_UID LED Pin Definitions (JF1)	
Pin#	Definition
7	Blue_UID LED
8	OH/Fan Fail/Power Fail Cathode

**Power Fail LED**

The Power Fail LED connection is located on pins 5 and 6 of JF1. Refer to the table on the right for pin definitions.

PWR Fail LED Pin Definitions (JF1)	
Pin#	Definition
5	3.3V
6	PWR Supply Fail

A. (Blue) UID LED

B. (Red) OH/Fan Fail/PWR Fail LED

C. PWR Fail

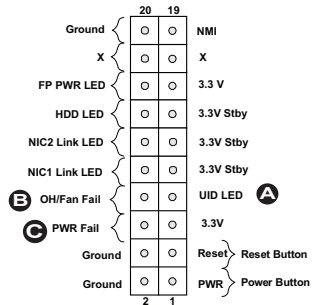
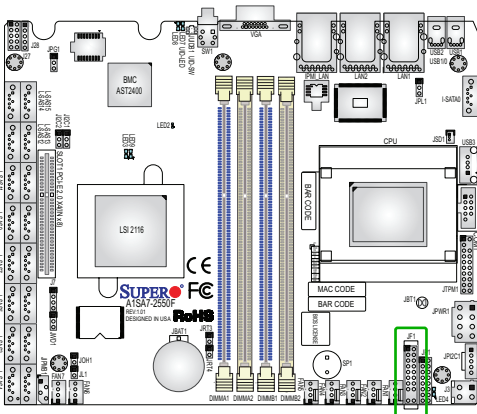

### Reset Button

The Reset Button connection is located on pins 3 and 4 of JF1. Attach it to a hardware reset switch on the computer case to reset the system. Refer to the table on the right for pin definitions.

Reset Button Pin Definitions (JF1)	
Pin#	Definition
3	Reset
4	Ground

### Power Button

The Power Button connection is located on pins 1 and 2 of JF1. Momentarily contacting both pins will power on/off the system. This button can also be configured to function as a suspend button (with a setting in the BIOS - see Chapter 4). To turn off the power in the suspend mode, press the button for at least 4 seconds. Refer to the table on the right for pin definitions.

Power Button Pin Definitions (JF1)	
Pin#	Definition
1	Signal
2	+3V Standby

A. Reset Button

B. PWR Button

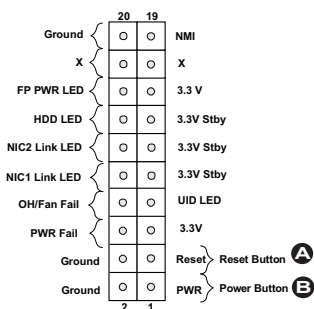
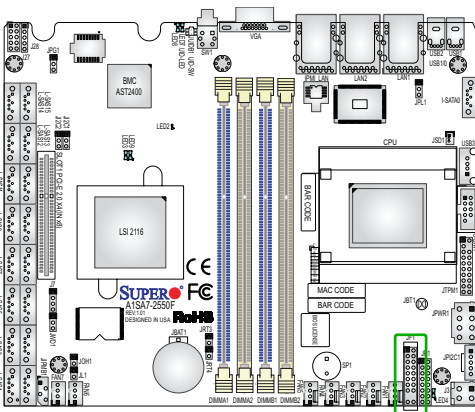

## 2-6 Connecting Cables

This section provides brief descriptions and pin-out definitions for onboard headers and connectors. Be sure to use the correct cable for each header or connector. For information on Backpanel USB and Front Panel USB ports, refer to page 2-12.

### Motherboard Power Input (JPWR1)

The 8-pin power connector located at JPWR1 is required for the 12V power source.

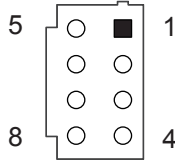

12V 8-Pin Power Connector Pin Definitions	
Pin#	Definition
1-4	Ground
5-8	P12V_ATX

### 4-pin Power Connector J3

The 4-pin power connector J3 provides power to 5V standby power source to the motherboard.

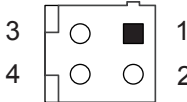

4-Pin Power Connector Pin Definitions	
Pin#	Definition
1-2	Ground
3	P5V_STBY
4	PS_ON

 **Note:** The A1SA7 motherboard requires proprietary power source design with only 12V and 5V standby input.

A. 8-Pin 12V Power Source

B. 4-Pin Standby Power Source

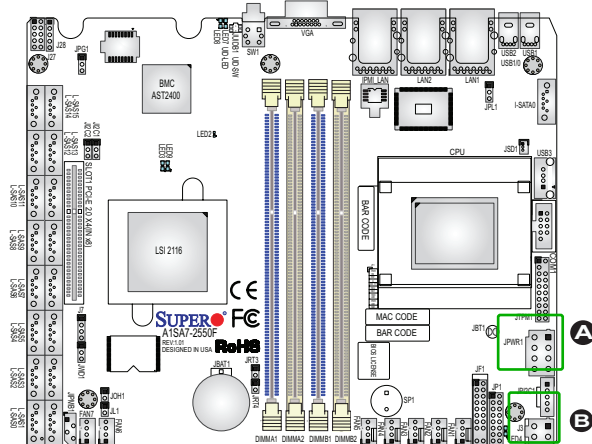

### Fan Headers (Fan 1 ~ Fan 7)

The A1SA7-2750F/2550F motherboard has seven fan headers. These fans are 4-pin fan headers. Although pins 1-3 of the fan headers are backward compatible with the traditional 3-pin fans, we recommend you use 4-pin fans to take advantage of the fan speed control via Pulse Width Modulation through the BMC. This allows the fan speeds to be automatically adjusted based on the motherboard temperature. Refer to the table on the right for pin definitions.

Fan Header Pin Definitions	
Pin#	Definition
1	Ground (Black)
2	2.5A/+12V (Red)
3	Tachometer
4	PWM_Control

### Chassis Intrusion (JL1)

A Chassis Intrusion header is located at JL1 on the motherboard. Attach the appropriate cable from the chassis to inform you of a chassis intrusion when the chassis is opened.

Chassis Intrusion Pin Definitions (JL1)	
Pin#	Definition
1	Intrusion Input
2	Ground

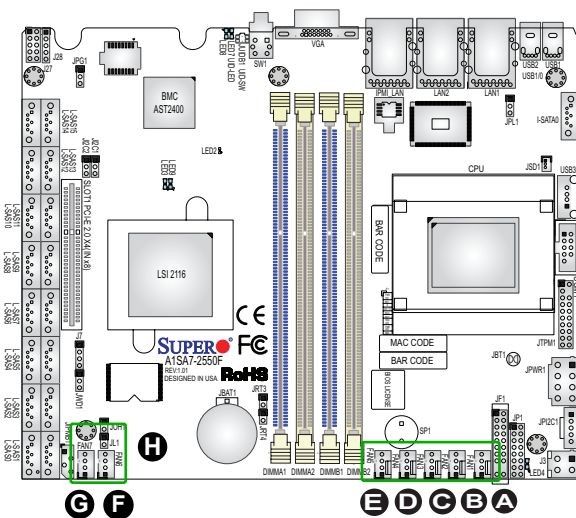

- A. Fan 1
- B. Fan 2
- C. Fan 3
- D. Fan 4
- E. Fan 5
- F. Fan 6
- G. Fan 7
- H. Chassis Intrusion



### Internal Buzzer (SP1)

The Internal Buzzer (SP1) can be used to provide audible indications for various beep codes. See the table on the right for pin definitions.

Internal Buzzer Pin Definition		
Pin#	Definitions	
Pin 1	Pos. (+)	Beep In
Pin 2	Neg. (-)	Alarm Speaker

### DOM PWR Connector (JSD1)

The Disk-On-Module (DOM) power connector, located at JSD1, provides 5V power to a solid state DOM storage device connected to the SATA port. See the table on the right for pin definitions.

DOM PWR Pin Definitions	
Pin#	Definition
1	5V
2	Ground
3	Ground

- A. Internal Buzzer
- B. DOM Power

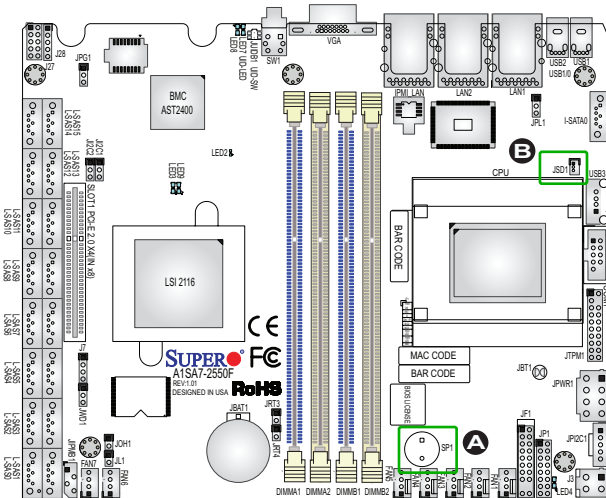

**TPM Header/Port 80 Header**

A Trusted Platform Module/Port 80 header, located at JTPM1, provides Trusted-Platform (TPM) support and Port 80 connection. Use this header to enhance system performance and data security. See the table on the right for pin definitions.

TPM/Port 80 Header Pin Definitions			
Pin #	Definition	Pin #	Definition
1	LCLK	2	GND
3	LFRAME#	4	<(KEY)>
5	LRESET#	6	+5V (X)
7	LAD 3	8	LAD 2
9	+3.3V	10	LAD1
11	LAD0	12	GND
13	SMB_CLK4	14	SMB_DAT4
15	+3V_DUAL	16	SERIRQ
17	GND	18	CLKRUN# (X)
19	LPCPD#	20	LDRQ# (X)

**Overheat LED Header**

The JOH1 header is used to connect an LED indicator to provide warnings of chassis overheating and fan failure. This LED will blink when a fan failure occurs. Refer to the tables on right for pin definitions.

Overheat LED Pin Definitions	
Pin	Definition
1	5vDC
2	OH Active

OH/Fan Fail/PWR Fail LED Status (Red LED)	
State	Definition
Off	Normal
Solid	Overheat
Flashing	Fan Fail

A. TPM Header

B. Overheat LED Header

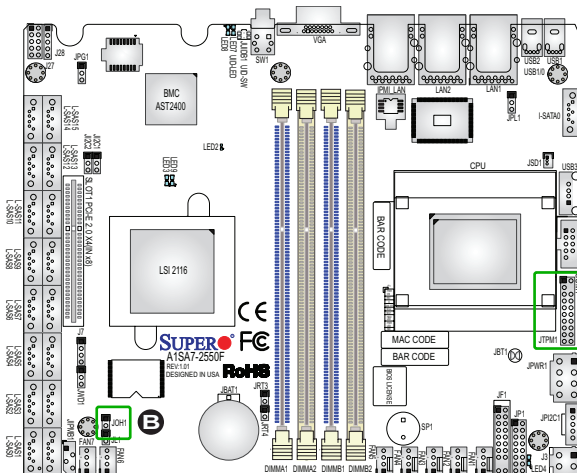

### Power SMB (I<sup>2</sup>C) Connector

Power System Management Bus (I<sup>2</sup>C) Connector (JPI<sup>2</sup>C1) monitors power supply, fan and system temperatures. See the table on the right for pin definitions.

PWR SMB Pin Definitions	
Pin#	Definition
1	Clock
2	Data
3	PWR Fail
4	Ground
5	+3.3V

### System Management Bus Header

A System Management Bus header for IPMI 2.0 is located at JIPMIB1. Connect the appropriate cable here to use the IPMI I<sup>2</sup>C connection on your system.

SMBus Header Pin Definitions	
Pin#	Definition
1	Data
2	Ground
3	Clock
4	No Connection

A. SMBus Power

B. SMBus Header

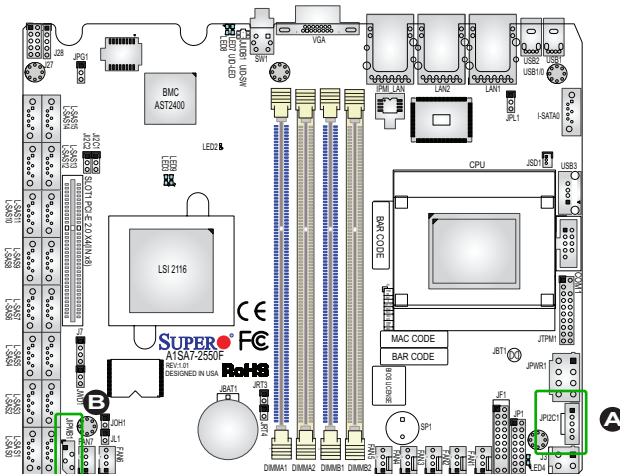

## 2-7 Jumper Settings

### Explanation of Jumpers

To modify the operation of the motherboard, jumpers can be used to choose between optional settings. Jumpers create shorts between two pins to change the function of the connector. Pin 1 is identified with a square solder pad on the printed circuit board.



**Note:** On two-pin jumpers, "Closed" means the jumper is on, and "Open" means the jumper is off the pins.

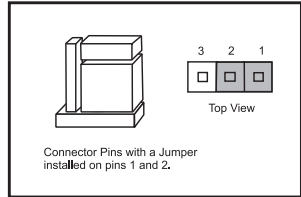
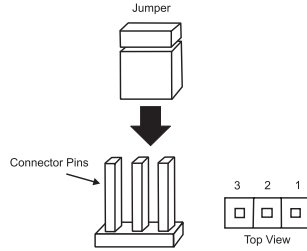

### LAN Ports Enable/Disable

Jumper JPL1 enables or disables Ethernet LAN ports on the motherboard. See the table on the right for jumper settings. The default setting is enabled.

GbE LAN Enable Jumper Settings	
Pin#	Definition
1-2	Enabled (default)
2-3	Disabled

A. LAN Ports Enable or Disable

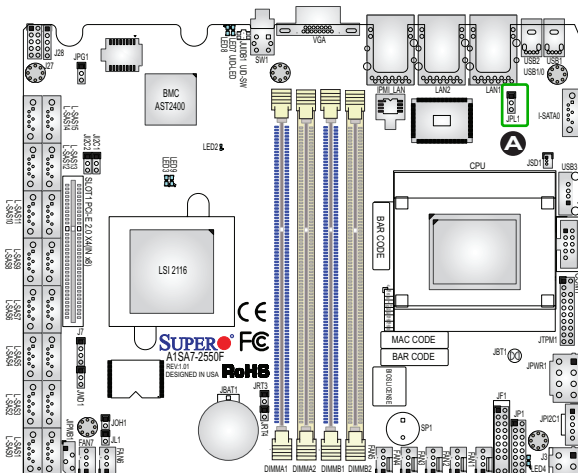

## CMOS Clear

JBT1 is used to clear CMOS. Instead of pins, this "jumper" consists of contact pads to prevent accidental clearing of CMOS. To clear CMOS, use a metal object such as a small screwdriver to touch both pads at the same time to short the connection. Always remove the AC power cord from the system before clearing CMOS.



**Note 1:** For an ATX power supply, you must completely shut down the system, remove the AC power cord, and then short JBT1 to clear CMOS.

**Note 2:** Be sure to remove the onboard CMOS Battery before you short JBT1 to clear CMOS.

**Note 3:** Clearing CMOS will also clear all passwords.

## PCI-E Slot SMB Enable (I<sup>2</sup>C1/I<sup>2</sup>C2)

Use Jumpers I<sup>2</sup>C1/I<sup>2</sup>C2 to enable PCI SMB (System Management Bus) support to improve system management for the onboard PCI-E slot. See the table on the right for jumper settings.

PCI Slot_SMB Enable Jumper Settings	
Jumper Setting	Definition
Short	Enabled
Open (Default)	Disabled

A. Clear CMOS

B. JI<sup>2</sup>C1

C. JI<sup>2</sup>C2

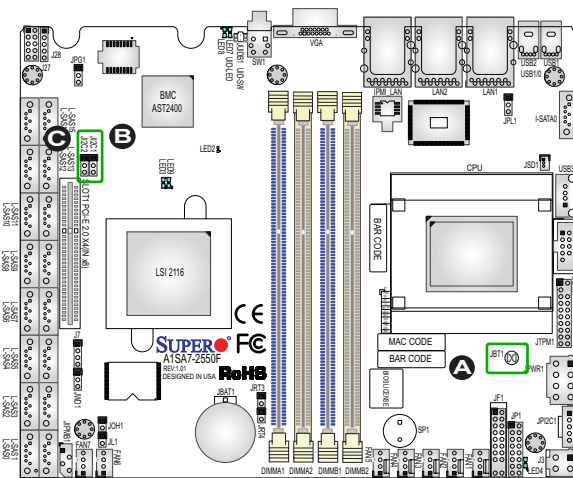

### Watch Dog Timer Enable

Watch Dog (JWD1) is a system monitor that can be used to reboot the system when a software application hangs. Close pins 1-2 to reset the system if an application hangs. Close pins 2-3 to generate a non-maskable interrupt signal for the application that hangs. See the table on the right for jumper settings. Watch Dog must also be enabled in the BIOS.

Watch Dog Jumper Settings	
Jumper Setting	Definition
Pins 1-2	Reset (default)
Pins 2-3	NMI
Open	Disabled

### VGA Enable

Jumper JPG1 allows the user to enable the onboard VGA connector. The default setting is pins 1-2 to enable the connection. See the table on the right for jumper settings.

VGA Enable Jumper Settings	
Jumper Setting	Definition
Pins 1-2	Enabled (Default)
Pins 2-3	Disabled

A. Watch Dog Enable

B. VGA Enable

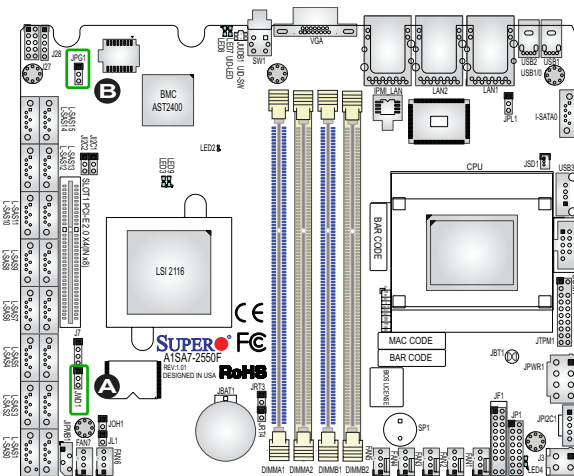

## 2-8 Onboard Indicators

### GbE LAN LEDs

There are two GbE LAN ports on the motherboard. Each Gigabit Ethernet LAN port has two LEDs. The Yellow LED on the right indicates connection and activity. The Link LED on the left side may be green, amber or off to indicate the speed of the connection. See the tables on the right for more information.



**Rear View** (when facing the rear side of the chassis)

GbE LAN Activity Indicator (Right) LED Settings		
Color	Status	Definition
Off	No Connections	
Yellow	Flashing	Active

### IPMI Dedicated LAN LEDs

In addition to LAN ports, an IPMI Dedicated LAN is also located on the I/O Backplane of the motherboard. The amber LED on the right indicates connection and activity, while the green LED on the left indicates the speed of the connection. See the table on the right for more information.

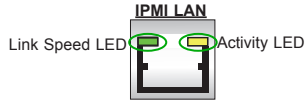

BMC Heartbeat LED Status	
Color/State	Definition
Green:Blinking	BMC: Normal

A. LAN LEDs

B. IPMI LAN LED

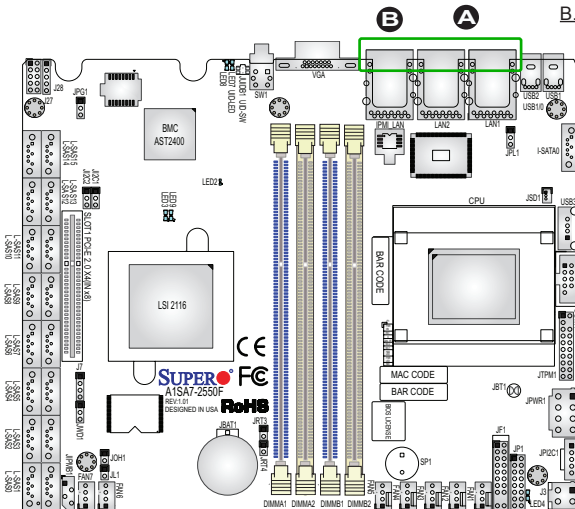

### LSI SAS2116 Heartbeat LED

The LSI SAS2116 Heartbeat LED is located at LED3. When the green light is blinking, the SAS controller is in the normal state. See the table on the right for LED settings.

SAS Heartbeat LED Indicator Settings	
LED Color	Definition
Green: Blinking	SAS Controller: Normal

### LSI SAS2116 Error LED

The LSI SAS2116 Error LED is located at LED9. When the red light is on, there is an error with the SAS controller. See the table on the right for LED settings.

SAS Error LED Indicator Settings	
LED Color	Definition
Red: On	Error
Off	Normal

A. LSI SAS2116 Heartbeat LED

B. LSI SAS2116 Error LED

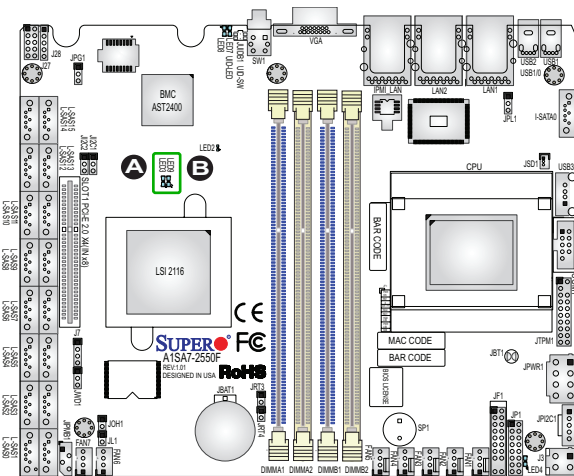



### Unit Identification LED

A rear UID LED indicator (LED7) is located next to the Unit Identifier (UID) switch on the I/O backplane. The front panel UID LED is located at Pin 7 of the Front Control Panel at JF1. Connect a cable to Pin 7 on JF1 for front panel UID LED indication. When you press the UID switch, both rear UID LED and front panel UID LED Indicators will be turned on. Press the UID switch again to turn off both LED Indicators. These UID Indicators provide easy identification of a system unit that may be in need of service.

UID LED Status		
Color/State	OS	Status
Blue: On	Windows OS	Unit Identified
Blue: Blinking	Linux OS	Unit Identified

**Note:** UID can also be triggered via IPMI on the motherboard. For more information on IPMI, please refer to the IPMI User's Guide posted on our website @ <http://www.supermicro.com>.

### Overheat/PWR Fail/Fan Fail LED

An onboard Overheat/PWR Fail/Fan Fail LED is located at LED8. See the tables on the right for more information.

Overheat/PWR Fail/Fan Fail LED Settings	
Color/State	Definition
Solid	Overheat
Blinking	PWR Fail or Fan Fail

- A. UID LED
- B. OH/PWR Fail/Fan Fail LED

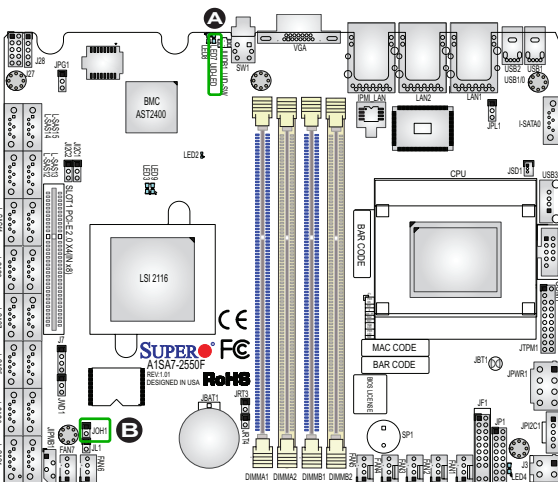

## 2-9 SATA Connections

### SATA Ports

There is one SATA 3.0 and 16 SATA3/SAS2 ports on the motherboard. These ports provide serial-link signal connections, which are faster than the connections of Parallel ATA.

- |                    |                     |  |
|--------------------|---------------------|--|
| <u>A. L-SAS #0</u> | <u>I. L-SAS #8</u>  | <u>Q. I-SATA #0 (the I-SATA port support Supermicro built in power SATA DOM)</u> |
| <u>B. L-SAS #1</u> | <u>J. L-SAS #9</u>  |  |
| <u>C. L-SAS #2</u> | <u>K. L-SAS #10</u> |  |
| <u>D. L-SAS #3</u> | <u>L. L-SAS #11</u> |  |
| <u>E. L-SAS #4</u> | <u>M. L-SAS #12</u> |  |
| <u>F. L-SAS #5</u> | <u>N. L-SAS #13</u> |  |
| <u>G. L-SAS #6</u> | <u>O. L-SAS #14</u> |  |
| <u>H. L-SAS #7</u> | <u>P. L-SAS #15</u> |  |

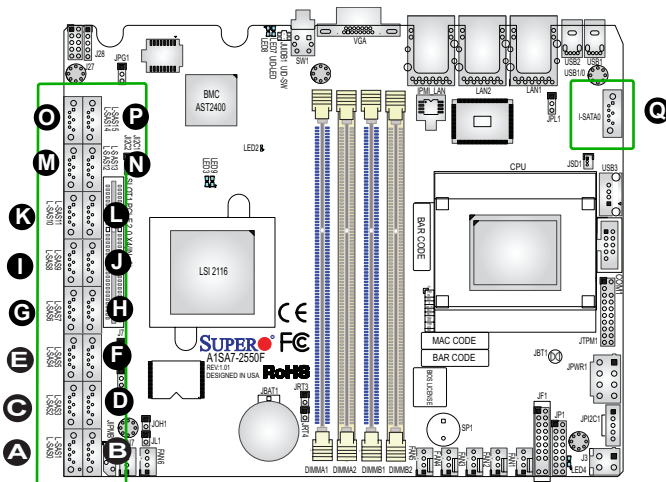

## Chapter 3

# Troubleshooting

### 3-1 Troubleshooting Procedures

Use the following procedures to troubleshoot your system. If you have followed all of the procedures below and still need assistance, refer to the 'Technical Support Procedures' and/or 'Returning Merchandise for Service' section(s) in this chapter. Always disconnect the AC power cord before adding, changing or installing any hardware components.

#### Before Power On

1. Make sure that the Standby PWR LED is not on. (**Note:** If it is on, the onboard power is on. Be sure to unplug the power cable before installing or removing the components.)
2. Make sure that there are no short circuits between the motherboard and chassis.
3. Disconnect all ribbon/wire cables from the motherboard, including those for the keyboard and mouse. Also, be sure to remove all add-on cards.

#### No Power

1. Make sure that there are no short circuits between the motherboard and chassis.
2. Make sure that all jumpers are set to their default positions.
3. Check if the 115V/230V switch on the power supply is properly set.
4. Turn the power switch on and off to test the system.
5. The battery on your motherboard may be old. Check to make sure that it still supplies ~3VDC. If it does not, replace it with a new one.

#### No Video

1. If the power is on, but you have no video, you will need to remove all the add-on cards and cables first.

2. Use the speaker to determine if any beep codes exist. (Refer to Appendix A for details on beep codes.)
3. Remove all memory modules and turn on the system. (If the alarm is on, check the specifications of memory modules, reset the memory or try a different one.)

### **Memory Errors**

1. Make sure that the DIMM modules are properly installed and fully seated in the slots.
2. You should be using unbuffered ECC/Non-ECC DDR3 DIMM (1.5V, 1.35V) 1600/1333 MHz memory recommended by the manufacturer. Also, it is required that you use the memory modules of the same type and speed for all DIMMs in the system. Do not use memory modules of different sizes, different speeds, nor different types on the same motherboard.
3. Check for bad DIMM modules or slots by swapping modules between slots to see if you can locate the faulty ones.
4. Check the switch of 115V/230V power supply.

### **Losing the System's Setup Configuration**

1. Please be sure to use a high quality power supply. A poor quality power supply may cause the system to lose CMOS setup information. Refer to Section 1-6 for details on recommended power supplies.
2. The battery on your motherboard may be old. Check to verify that it still supplies ~3VDC. If it does not, replace it with a new one.
3. If the above steps do not fix the Setup Configuration problem, contact your vendor for repairs.

## **3-2 Technical Support Procedures**

Before contacting Technical Support, please make sure that you have followed all the steps listed below. Also, Note that as a motherboard manufacturer, Supermicro does not sell directly to end users, so it is best to first check with your distributor or

reseller for troubleshooting services. They should know of any possible problem(s) with the specific system configuration that was sold to you.

1. Please go through the 'Troubleshooting Procedures' and 'Frequently Asked Question' (FAQ) sections in this chapter or see the FAQs on our website (<http://www.supermicro.com/support/faqs/>) before contacting Technical Support.
2. BIOS upgrades can be downloaded from our website at (<http://www.supermicro.com/support/bios/>).



**Note:** Not all BIOS can be flashed. Some cannot be flashed; it depends on the boot block code of the BIOS.

3. If you've followed the instructions above to troubleshoot your system, and still cannot resolve the problem, then contact Supermicro's technical support and provide them with the following information:
  - Motherboard model and PCB revision number
  - BIOS release date/version (this can be seen on the initial display when your system first boots up)
  - System configuration
  - An example of a Technical Support form is on our website at (<http://www.supermicro.com/RmaForm/>).
4. Distributors: For immediate assistance, please have your account number ready when placing a call to our technical support department. We can be reached by e-mail at [support@supermicro.com](mailto:support@supermicro.com), by phone at: (408) 503-8000, option 2, or by fax at (408)503-8019.

### 3-3 Frequently Asked Questions

**Question:** What type of memory does my motherboard support?

**Answer:** The A1SA7-2750F/2550F motherboard supports up to 64 GB of DDR3 ECC/Non-ECC Unbuffered UDIMM 1600/1333 MHz. See Section 2-3 for details on installing memory.

**Question:** How do I update my BIOS?

**Answer:** We do NOT recommend that you upgrade your BIOS if you are not experiencing any problems with your system. Updated BIOS files are located on our website at <http://www.supermicro.com/support/bios/>. Please check our BIOS warning message and the information on how to update your BIOS on our web site. Select your motherboard model and download the BIOS ROM file to your computer. Also, check the current BIOS revision to make sure that it is newer than your BIOS before downloading. You may choose the zip file or the .exe file. If you choose the zipped BIOS file, please unzip the BIOS file onto a bootable device or a USB pen/thumb drive. To flash the BIOS, run the batch file named "ami.bat" with the new BIOS ROM file from your bootable device or USB pen/thumb drive. Use the following format:

```
F:\> ami.bat BIOS-ROM-filename.xxx <Enter>
```



**Note:** Always use the file named "ami.bat" to update the BIOS, and insert a space between "ami.bat" and the BIOS ROM image file name.

If you choose the .exe file, please run the .exe file under Windows to create the BIOS flash floppy disk. Insert the floppy disk into the system you wish to flash the BIOS. Then, boot the system to the floppy disk. The BIOS utility will automatically flash the BIOS without any prompts. Please note that this process may take a few minutes to complete. Do not be concerned if the screen is paused for a few minutes.

When the BIOS flashing screen is completed, the system will reboot and will show "Press F1 or F2". At this point, you will need to load the BIOS defaults. Press <F1> to go to the BIOS setup screen, and press <F9> to load the default settings. Next, press <F10> to save and exit. The system will then reboot.

**Warning:** Do not shut down or reset the system while updating the BIOS to prevent possible system boot failure!



**Important:** The SPI BIOS chip installed on this motherboard is not removable. To repair or replace a damaged BIOS chip, please send your motherboard to RMA at Supermicro for service.

## 3-4 Battery Removal and Installation

### Battery Removal

To remove the onboard battery, follow the steps below:

1. Power off your system and unplug your power cable.
2. Locate the onboard battery as shown below.
3. Using a tool such as a pen or a small screwdriver, push the battery lock outwards to unlock it. Once unlocked, the battery will pop out from the holder.
4. Remove the battery.

### Proper Battery Disposal

**Warning:** Please handle used batteries carefully. Do not damage the battery in any way; a damaged battery may release hazardous materials into the environment. Do not discard a used battery in the garbage or a public landfill. Please comply with the regulations set up by your local hazardous waste management agency to dispose of your used battery properly.

### Battery Installation

1. To install an onboard battery, follow the steps 1 & 2 above and continue below:
2. Identify the battery's polarity. The positive (+) side should be facing up.
3. Insert the battery into the battery holder and push it down until you hear a click to ensure that the battery is securely locked.

**Warning:** When replacing a battery, be sure to only replace it with the same type.

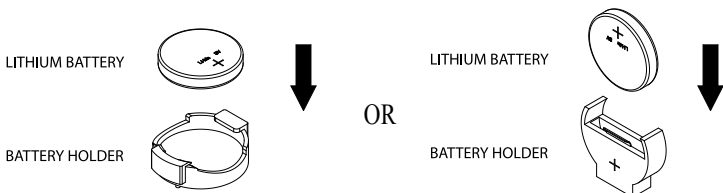

### **3-5 Returning Merchandise for Service**

A receipt or copy of your invoice marked with the date of purchase is required before any warranty service will be rendered. You can obtain service by calling your vendor for a Returned Merchandise Authorization (RMA) number. For faster service, you may also obtain RMA authorizations online (<http://www.supermicro.com/RmaForm/>). When you return the motherboard to the manufacturer, the RMA number should be prominently displayed on the outside of the shipping carton, and mailed prepaid or hand-carried. Shipping and handling charges will be applied for all orders that must be mailed when service is complete.

This warranty only covers normal consumer use and does not cover damages incurred in shipping or from failure due to the alteration, misuse, abuse or improper maintenance of products.

During the warranty period, contact your distributor first for any product problems.



---

---

## Chapter 4

### BIOS

#### 4-1 Introduction

This chapter describes the AMI BIOS setup utility for the A1SAi & A1SRi Series motherboard. The ROM BIOS is stored in a Flash EEPROM and can be easily updated. This chapter describes the basic navigation of the AMI BIOS setup utility setup screens.



**Note:** For AMI BIOS Recovery, please refer to the UEFI BIOS Recovery Instructions in Appendix C.

#### Starting BIOS Setup Utility

To enter the AMI BIOS setup utility screens, press the <Delete> key while the system is booting up.



**Note:** In most cases, the <Delete> key is used to invoke the AMI BIOS setup screen. There are a few cases when other keys are used, such as <F1>, <F2>, etc.

Each main BIOS menu option is described in this manual. The Main BIOS setup menu screen has two main frames. The left frame displays all the options that can be configured. Grayed-out options cannot be configured. Options in blue can be configured by the user. The right frame displays the key legend. Above the key legend is an area reserved for a text message. When an option is selected in the left frame, it is highlighted in white. Often a text message will accompany it. (**Note:** the AMI BIOS has default text messages built in. Supermicro retains the option to include, omit, or change any of these text messages.)

The AMI BIOS setup utility uses a key-based navigation system called "hot keys". Most of the AMI BIOS setup utility "hot keys" can be used at any time during the setup navigation process. These keys include <F1>, <F4>, <Enter>, <ESC>, arrow keys, etc.



**Note:** Options printed in **Bold** are default settings.

#### How To Change the Configuration Data

The configuration data that determines the system parameters may be changed by entering the AMI BIOS setup utility. This setup utility can be accessed by pressing <Del> at the appropriate time during system boot.

## How to Start the Setup Utility

Normally, the only visible Power-On Self-Test (POST) routine is the memory test. As the memory is being tested, press the <Delete> key to enter the main menu of the AMI BIOS setup utility. From the main menu, you can access the other setup screens. An AMI BIOS identification string is displayed at the left bottom corner of the screen, below the copyright message.

**Warning:** Do not update the BIOS unless your system has a BIOS-related issue. Flashing the wrong BIOS can cause irreparable damage to the system. In no event shall Supermicro be liable for direct, indirect, special, incidental, or consequential damages arising from a BIOS update. If you have to update the BIOS, do not shut down or reset the system while the BIOS is updating. This is to avoid possible boot failure.

## 4-2 Main Setup

When you first enter the AMI BIOS setup utility, you will enter the Main setup screen. You can always return to the Main setup screen by selecting the Main tab on the top of the screen. The Main BIOS Setup screen is shown below.

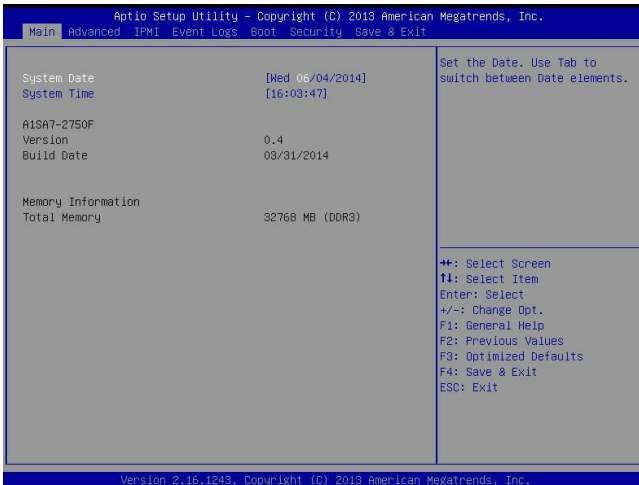

The following Main menu items will display:

### **System Date/System Time**

Use this feature to change the system date and time. Highlight *System Date* or *System Time* using the arrow keys. Enter new values using the keyboard. Press the <Tab> key or the arrow keys to move between fields. The date must be entered in Day MM/DD/YY format. The time is entered in HH:MM:SS format.



**Note:** The time is in the 24-hour format. For example, 5:30 P.M. appears as 17:30:00.

The following BIOS items will also be displayed:

### **Supermicro A1SA7-2750F**

#### **Version**

#### **Build Date**

#### **Memory Information**

#### **Total Memory**

This displays the total size of memory available in the system.

## 4-3 Advanced Setup Configurations

Use the arrow keys to select Boot Setup and press <Enter> to access the submenu items.

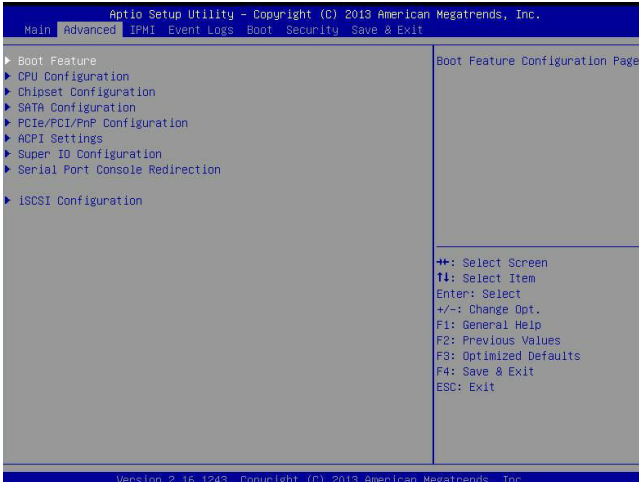

**Warning:** Take Caution when changing the Advanced settings. An incorrect value, a very high DRAM frequency, or an incorrect DRAM timing setting may make the system unstable. When this occurs, revert to the default to the manufacture default settings.

### ► Boot Feature

#### Quiet Boot

Use this feature to select the screen display between the POST messages and the OEM logo upon bootup. Select Disabled to display the POST messages. Select Enabled to display the OEM logo instead of the normal POST messages. The options are **Enabled** and Disabled.

#### CSM Support

Compatibility Support Module (CSM) provides compatibility support for traditional legacy BIOS, which allows booting an operating system that does not support a UEFI BIOS. The options are **Enabled** and Disabled.

#### AddOn ROM Display Mode

Use this feature to set the display mode for the Option ROM. Select Keep Current to display the current AddOn ROM setting. Select Force BIOS to use the Option ROM display set by the system BIOS. The options are **Force BIOS** and Keep Current.

**Bootup Num-Lock**

Use this feature to set the Power-on state for the <Numlock> key. The options are Off and **On**.

**Wait For 'F1' If Error**

Use this feature to force the system to wait until the 'F1' key is pressed if an error occurs. The options are Disabled and **Enabled**.

**Interrupt 19 Capture**

Interrupt 19 is the software interrupt that handles the boot disk function. When this item is set to Enabled, the ROM BIOS of the host adaptors will "capture" Interrupt 19 at bootup and allow the drives that are attached to these host adaptors to function as bootable disks. If this item is set to Disabled, the ROM BIOS of the host adaptors will not capture Interrupt 19, and the drives attached to these adaptors will not function as bootable devices. The options are **Immediately** and Postponed.

**►Power Configuration****Watch Dog Function**

If enabled, the Watch Dog Timer will allow the system to reboot when it is inactive for more than 5 minutes. The options are Enabled and **Disabled**.

**Power Button Function**

This feature controls how the system shuts down when the power button is pressed. Select 4\_Seconds\_Override for the user to power off the system after pressing and holding the power button for 4 seconds or longer. Select Instant Off to instantly power off the system as soon as the user presses the power button. The options are 4 Seconds Override and **Instant Off**.

**Restore on AC Power Loss**

Use this feature to set the power state after a power outage. Select Stay-Off for the system power to remain off after a power loss. Select Power-On for the system power to be turned on after a power loss. Select Last State to allow the system to resume its last power state before a power loss. The options are Power-On, Stay-Off and **Last State**.

**WOL (Wake-On\_LAN) Support**

Select Enabled to enable WOL support which will allow the system to "wake-up" when a device connected to a LAN port receives a signal. The options are Disabled and **Enabled**.

## ►CPU Configuration

The following CPU information will be displayed:

- Processor ID
- Processor Frequency
- Microcode Revision
- L1 Cache RAM
- L2 Cache RAM
- Processor Version

### Clock Spread Spectrum

If this feature is set to Enabled, the BIOS utility will monitor the level of Electro-magnetic Interference caused by the components and will attempt to reduce the interference whenever needed. The options are Enabled and **Disabled**.

### EIST (GV3)

EIST (Enhanced Intel SpeedStep Technology) GV3 allows the system to automatically adjust processor voltage and core frequency in an effort to reduce power consumption and heat dissipation. Select Auto to enable 80 CPU stepping support automatically and disabled other functions. The options are Disabled, Enabled, and **Auto**. **Please refer to Intel's web site for detailed information.**

### P-STATE Coordination

This feature selects the type of coordination for the P-State of the processor. P-State is a processor operational state that reduces the processor's voltage and frequency to enhance CPU energy efficiency. The options are Hardware, **Package**, and Module.

#### **TM1** (Available when supported by the CPU.)

Select Enable to activate TM1 support for system thermal monitoring. TM1 allows the CPU to regulate its power consumption based upon the modulation of the CPU Internal clock when the CPU temperature reaches a pre-defined overheating threshold. The options are Disabled and **Enabled**.

#### **TM2 Mode** (Available when supported by the CPU.)

Use this feature to select the throttling mode for TM2. The options are LEM Throttling and Adaptive Throttling.

### **CPU C-States**

C-States architecture, a processor power management platform developed by Intel, can further reduce power consumption from the basic C1 (Halt State) state that blocks clock cycles to the CPU. Select Enabled for CPU C-States support. The options are **Enabled** and Disabled. If this feature is set to Enabled, the following items will display:

#### **Package C-State limit**

Select Auto for the AMI BIOS to automatically set the limit on the C-State package register. The options are **No Limit**, C1 State, C2 State, C3 State, C4 State, and C6 (Non Retention) State.

#### **Enhanced Halt State (C1E) (Available when "CPU C-States" is set to Enabled)**

Select Enabled to support Enhanced C1 Power State to boost system performance. Please reboot the system for the new setting to take effect. The options are **Disabled** and Enabled.

#### **Monitor/Mwait**

If this item is set to Enable, the processor will carry out the "Monitor/Mwait" instruction by specifying an address that the BIOS should wait (Monitor) or should issue the command to for the "wait operation" (Mwait) instruction to be performed. The options are Disable and **Enable**.

#### **L1 Prefetcher (Available when supported by the CPU)**

If enabled, the hardware prefetcher will prefetch streams of data and instructions from the main memory to the L1 cache to improve CPU performance. The options are Disabled and **Enabled**.

#### **L2 Prefetcher (Available when supported by the CPU)**

If enabled, the hardware prefetcher will prefetch streams of data and instructions from the main memory to the L2 cache to improve CPU performance. The options are Disabled and **Enabled**.

#### **ACPI 3.0 T-States (Available when "CPU C-States" is set to Enabled)**

Select Enabled to support ACPI (Advanced Configuration and Power Interface) 3.0 T-States to determine how the processor will report to the operating system during CPU-Throttling states. The options are Enabled and **Disabled**.

#### **Fast String**

Select Enabled to enable Fast String support for REP MOVSB/STOSB, which will carry out Repeat-String Operation instructions to move a string of commands to another

location (MOVS) or to add a string of commands to an existing instruction code (STOS). The options are Disabled and **Enabled**.

### **Machine Check**

Select Enabled to use Intel's machine check mechanism to detect and report hardware (machine) errors. The options are Disabled and **Enabled**.

### **Max CPUID Value Limit**

Use this feature to set the maximum CPU ID value. Enable this feature to boot the legacy operating systems that cannot support processors with extended CPUID functions. The options are Enabled and **Disabled** (for the Windows OS.)

### **Execute Disable Bit (Available if supported by the OS & the CPU)**

Set to Enabled to enable the Execute Disable Bit which will allow the processor to designate areas in the system memory where an application code can execute and where it cannot, thus preventing a worm or a virus from flooding illegal codes to overwhelm the processor and damage the system during an attack. The default is **Enabled**. (Refer to Intel and Microsoft Web Sites for more information.)

### **VMX (Available when supported by the CPU)**

Select Enabled to enable Intel Vanderpool Technology support which will allow one platform to run multiple operating systems and applications in independent partitions, creating multiple "virtual" systems in one physical computer. The options are **Enabled** and Disabled.

### **BIST (Available when supported by the CPU)**

Activate this feature to enable the motherboard's Built-in Self Test (BIST) function, which is a mechanism that permits the motherboard to test itself for better reliability. The options are Enable and **Disable**.

### **AES-NI**

Select Enabled to use the Advanced Encryption Standard in the processor. The options are **Enabled** and Disabled.

### **PECI Enable**

Enable this feature to activate the Platform Environment Control Interface (PECI), a thermal management scheme which uses on-die (inside the CPU) digital thermal sensors. The options are Enabled and **Disabled**.

### **PECI Trusted**

Select Enabled to support Trusted Platform Environment Control Interface to improve CPU thermal management. The options are **Disabled** and Enabled.



**PECI SMBus Speed**

This feature sets the the speed the physical PECI SMBus must operate under. The options are **Standard (80 KHz)**, Standard (100 KHz), Fast Mode (400 KHz) and Fast Mode Plus (1 MHz).

**Turbo (Available if Intel® EIST technology is Enabled)**

This feature allows processor cores to run faster than marked frequency in specific conditions. The options are Disabled and **Enabled**.

**RAPL**

Activate RAPL, which stands for Running Average Power Limit, to provide mechanisms to enforce power consumption limits on supported processors. The options are **Enable** and Disable.

**MSR 606 PKG\_POWER\_SKU\_UNIT**

Use the keyboard to enter the number of the computer units that are SKU-specific in terms of power, energy, and time are concerned. .

**MSR 610 PKG\_TURBO\_PWR\_LIM**

Use this feature to specify the processor power consumption limits during short and long duration.

**MSR 670 PKG\_TURBO\_CFG1**

Use this feature to specify various parameters of system components such as Turbo, Minimum Energy, SoC TDP Policy, ICMAX Control, and Turbo Mode.

**MSR 672\_TURBO\_WKLD\_CFG2**

Use this feature to specify ICCMAX Throttle Ratio for C6 Exits when the value of PKG\_TURBO\_CFG1 [4:3] equals to 10Y.

**Active Processor Cores**

This feature determines how many CPU cores will be activated for each CPU. When all is selected, all cores in the CPU will be activated. (Please refer to Intel's web site for more information.) The options are **All**, 4, and 2.

**CPU Flex Ratio Override**

Activate this feature to allow programming of the CPU Core Ratio (below). The options are **Disable**, and Enable.

**CPU Core Ratio**

If activated above, this feature will allow the CPU Core Ratio to be programmed. Using the keyboard, enter only numeric characters according to the CPU ratio desired.

## ►Chipset Configuration

**Warning!** Setting the wrong values in the following features may cause the system to malfunction.

### ►North Bridge

The following information will be displayed:

- Memory Information
- MRC Version
- Total Memory
- Memory Frequency

### ►Pass Gate Setup

Use the following items to configure Pass Gate settings and tests.

#### Pass Gate Feature Enable

Select Enabled to support Pass Gate features. The options are **Enabled** and Disabled.

#### 2x Refresh Rate

Select Enabled to force the BIOS setup utility to use the x2 refresh rate in Pass-Gate operation regardless the temperatures of the processor and the motherboard. Refresh Rate is the total number of rows needed to refresh the entire DRAM array. x2 Refresh Rate will take 2000 rows of memory to refresh the entire DRAM array. The options are **Disabled** and Enabled.

#### Pass Gate Stress Test Configuration

##### Pass Gate Test

Select Enabled to use the Pass Gate test. The options are **Disabled** and Enabled.

##### Pass Gate Refresh

Select Enabled to refresh the period during the pass gate test. The options are **Disabled** and Enabled.

**Pass Gate Test Direction**

This feature specifies how the BIOS setup utility should perform the Pass Gate test (from the lowest memory to the highest or from the highest memory to the lowest.) The options are **Lowest to Highest** and Highest to Lowest.

**Pass Gate Test Repetition**

Use this feature to specify how many times the Pass Gate test should be performed over the same memory row (x1000). The default setting is **900**.

**Pass Gate Test Iterations**

Use this feature to specify how many repetitions the Pass Gate test should be performed over the same memory row (refer to the item above). The default setting is **1**.

**Pass Gate Test Swizzle (For Samsung Products)**

Select Enabled to use the Pass Gate Test Swizzle mode to support Samsung products. Select Auto for the system to automatically switch to the Pass Gate Test Swizzle mode when a Samsung device is detected. The options are **Auto** and Enabled.

**Pass Gate Pattern**

Use the keyboard to enter the parameter value of the Pass Gate Pattern used for data input. The options are **0's** and **1's**.

**Pass Gate Target Pattern**

Use the keyboard to enter the target parameter value for the Pass Gate Pattern used for data input. The options are **0's** and **1's**.

**Pass Gate Speed**

Use this feature to set the Pass Gate speed. The options are Auto and **1x Only**.

**Channel 0****Rank 0/Rank 1/Rank 2/Rank 3**

Select Enabled to allow the Pass Gate test to be performed on a memory module specified by the user. The options are **Enabled** and Disabled.

**Pass Gate MonteCarlo**

Select Enabled to enable a algorithm search to find the maximum value of the Pass Gate test. The options are **Disabled** and Enabled.

### **Pass Gate Maximum Failures**

Use this feature to specify the maximum number that Pass Gate failures will be counted for.

### **Pass Gate Maximum Repetition**

Use this feature to specify the maximum number that the Pass Gate tests will be repeated.

### **Pass Gate Maximum Repetition**

Use this feature to specify the minimum number that the Pass Gate tests will be repeated.

### **Fast Boot**

Select Enabled to skip the routine memory procedure and attempt to boot the system using the last valid memory configuration settings at bootup. The options are **Disabled**, and Enabled.

### **Smm Size (MB)**

Use the keyboard to enter a value for the size of the SMM/TSEG region where 1 MB is aligned to.

### **Force Memory Map Ax**

Select Enabled to force the BIOS setup utility to specify the total number of Kb (or an error) of memory errors detected by the BIOS upon OS initialization. The options are **Enabled** and Auto.

### **Memory Frequency**

This feature sets the memory frequency limits for the DIMM modules installed on the the motherboard. The options are **Auto**, DDR3-1333 (MHz), and DDR3-1600 (MHz).

### **Memory Channels**

Use this feature to configure the settings for memory channels. The options are **Auto** and Single Channel.

### **MRC (Maximal Ratio Combining) Debug Messages**

Use this feature to set the debug output display in MRC. The options are Disabled, Minimum, **Medium**, and Maximum.

### **DDR Voltage**

Use this feature to set the DDR3 voltage setting. The default option is **100**.

**Fine DDR Voltage**

Use this feature to set the fine DDR3 voltage setting. The options are **Auto**, 1.25V, 1.35V, and 1.50V.

**CKE Power Down**

Select Enabled to enable CKE Power Down support which controls the low power mode for RAM in the active power standby mode. The options are **Enabled**, and Disabled.

**ECC (Error Correctable Correction) Support**

Select Enabled to enable ECC support. The options are **Enabled** and Disabled.

**Faulty Part Tracking**

Select Enabled to support faulty part tracking for the system to keep track of faulty memory parts. The options are **Disabled** and Enabled.

**On Correctable Faulty Part**

This feature displays the status of "On Correctable Faulty Part".

**Patrol Scrub Enable**

Patrol Scrubbing is a process that allows the CPU to correct correctable memory errors detected on a memory module and send the correction to the requestor (the original source). When this item is set to Enabled, North Bridge will read and write back one cache line every 16K cycles, if there is no delay caused by internal processing. By using this method, roughly 64 GB of memory behind North Bridge will be scrubbed every day. The options are Disabled and **Enabled**.

**Patrol Scrub Period**

Use this item to specify how often Patrol Scrubbing should be performed. Select 24 hours to allow Patrol Scrubbing to be performed every 24 hours. The options are **24 hours**, 10 hours, 4 hours, and 1 hour.

**Demand Scrub Enable**

Demand Scrubbing is a process that allows the CPU to correct correctable memory errors found on a memory module. When the CPU or I/O issues a demand-read command, and the read data from memory turns out to be a correctable error, the error will be corrected and sent to the requestor (the original source). Memory will be updated at the same time. Select Enabled to use Demand Scrubbing for ECC memory correction. The options are **Enabled** and Disabled.

### **AB Segments In DRAM**

When this feature is set to Enabled, Target A- or B- segments will be routed to DRAM during memory read and write cycles. The options are Enabled and **Disabled**.

### **E Segment In DRAM**

When this feature is set to Enabled, Target E segment will be routed to DRAM during memory read and write cycles. The options are **Enabled** and Disabled.

### **F Segment In DRAM**

When this feature is set to Enabled, Target F segment will be routed to DRAM during memory read and write cycles. The options are **Enabled** and Disabled.

### **ZQ Calibration**

When this feature is set to Enabled, commands to calibrate DRAM output drivers will be issued so that ZQ Calibration will be performed during a system boot or system reset. The options are **Enabled** and Disabled.

### **Propagate Errors to Cores**

Select Enabled to enable Machine Check mode to propagate errors to cores. The options are Enabled and **Disabled**.

### **CMD Rate (Command Rate)**

Use this feature to set the CMD rate, which is the number of clock cycles needed for the memory to send data. The options are **Auto**, 1N, 2N and 3N.

### **Out-of-Order Memory Processing**

Select Enabled to support Out-of-Order Memory Processing, which is a process used by a computer to retrieve instructions from its memory to improve CPU performance. The options are **Enabled** and Disabled.

### **Out-of-Order Aging Threshold**

In a multi-core architecture, the DRAM system in a computer processes multiple threads or streams of requests from the In\_Order (FIFO: First\_In\_First\_Out) queue and the Out\_of\_Order queue in the interleaved/interconnect mode. This feature allows the user to specify the maximum number of requests to be processed for the same order before the system moves on and process the next thread of requests in the "Out\_Of\_Order" queue while in the "Out\_of\_Order" cycle. Once the "Out\_of\_Order" cycle expires, the system will move to the "In\_Order" cycle and starts to process the requests in the "In-Order" queue. The default setting is **31**.

**New Request Bypass**

Select Enabled for the system to skip the process currently in progress and process a new request immediately. The options are **Enabled** and Disabled.

**Dynamic Self Refresh**

Select Enabled to support Dynamic Self-Refreshing for the onboard memory controller. The options are **Enabled** and Disabled.

**PMOP Value for PCO**

Use the keyboard to enter the Opcode value for the SPID Power Mode. The default setting is **4**.

**PMOP Value for PCX**

Use the keyboard to enter the PCX value for the SPID Power Mode. The default setting is **7**.

**Per-Bit Margins**

Select Enabled to set the "per-bit margins" used in the Maximal Ratio Combining (MRC) technique. The options are **Disabled** and Enabled.

**Open Page Policy Timer**

Use the feature to set the Page\_Closure timer, which will specify how long a DRAM memory page should remain open. The options are Disabled, Immediate, **30-60 ns**, .60-120 ns, 120-240 ns, 240-480 ns, 480-960 ns, and 1-2 us.

**Memory Thermal**

Select Enabled to support Memory-Thermal-Management. The options are **Disabled** and Enabled.

**Scrambler**

Select Enabled to enable memory scrambler support for memory error correction. The settings are **Enabled** and Disabled.

**Slow Power Down Exit**

Select Enabled to use the slow-power-down mode when the system memory exits from the pre-charge state. The settings are **Enabled** and Disabled.

**Verf Override Enable**

Select Enabled to verify an override command before it is executed. The settings are **Disabled** and Enabled.

## ►South Bridge

### ►USB Configuration

This submenu displays the following sub-items:

- USB Module Version
- USB Devices

#### Legacy USB Support

This feature enables support for legacy USB devices. Select Auto to disable legacy support if USB devices are not present. Select Disable to have USB devices available only for EFI applications. The options are **Enabled**, Disabled and Auto.

#### EHCI Hand-Off

This item is for the Operating Systems that do not support Enhanced Host Controller Interface (EHCI) hand-off. When this item is enabled, EHCI ownership change will be claimed by the EHCI driver. The settings are Enabled and **Disabled**.

#### USB Mass Storage Driver Support

Select Enabled for USB Mass Storage Driver support. The options are **Enabled** and Disabled.

#### Port 60/64 Emulation

This feature enables or disables I/O port 60h/64h emulation support. This feature should be enabled for complete USB keyboard legacy support for operating systems that cannot detect the presence of USB devices. The options are **Disabled** and Enabled.

#### USB Hardware Delays and Time-Out

##### USB Transfer Time-Out

Use the keyboard to enter the time-out value for USB Control/Bulk/Interrupt transfers. The default setting is **20 seconds**.

##### Device Reset Time-Out

Use the keyboard to enter time-out value during a USB mass\_storage\_device reset. The options are **Auto** and Manual.



### **Device Power-Up Delay**

Use the feature to set the maximum time a USB device will wait before reporting itself to the host controller. Select Auto to use the manufacturer's default setting. Select Manual to set the default setting manually. The default setting is **20 seconds**.

## **►SATA Configuration**

When this submenu is selected, the AMI BIOS automatically detects the presence of the SATA Devices and displays the following items:

### **SATA 3 Controller**

This feature allows the user to configure the settings of SATA 3.0 devices

#### **SATA 3 Controller**

Select Enabled to enable the onboard SATA 3.0 controller. The options are **Enabled** and Disabled.

#### **SATA Mode**

This item sets SATA device mode. The options are IDE and **AHCI**.

#### **LPM (Link Power Management)**

Select Enabled to support Link Power Management to improve system power management. The options are Disabled, and **Enabled**.

##### **ALPM (Aggressive Link Power Management)**

Select Enabled to support Aggressive Link Power Management to enhance system power performance. The options are Disabled, and **Enabled**.

#### **Overwrite SIR Values**

Select Enabled to overwrite SIR values. The options are Enabled, and **Disabled**.

#### **SATA Port 0**

The submenu below allows the user to configure the following settings for SATA Port 0.

##### **Spin Up**

On an edge detect from 0 to 1, use this feature to set a COMRESET initialization sequence for a device. The options are Enabled and **Disabled**.

### Hot Plug

This feature designates this port for hot plugging. Set this item to Enabled for hot-plugging support, which will allow the user to replace a SATA drive without shutting down the system. The options are **Enabled** and Disabled.

### External Device

Select Enabled for external SATA device support. The options are **Enabled** and Disabled.

### Mechanical Switch

Select Enabled for mechanical switch support. The options are **Disabled** and Enabled.

## ► PCIe/PCI/PnP Configuration

### PCI Latency Timer

Use this feature to set the latency Timer of each PCI device installed on a PCI bus. Select 32 to set the PCI latency to 32 PCI clock cycles. The options are **32 PCI Bus Clocks**, 64 PCI Bus Clocks, 96 PCI Bus Clocks, 128 PCI Bus Clocks, 160 PCI Bus Clocks, 192 PCI Bus Clocks, 224 PCI Bus Clocks and 248 PCI Bus Clocks.

### VGA Palette Snoop

Select Enabled to support VGA palette register snooping which will allow the PCI cards that do not contain their own VGA color palettes to examine the video cards palette to mimic it for proper color display. The options are **Disabled** and Enabled.

### PERR# Generation

Select Enabled to allow a PCI device to generate a PERR number for a PCI Bus Signal Error Event. The options are **Disabled** and Enabled.

### SERR# Generation

Select Enabled to allow a PCI device to generate an SERR number for a PCI Bus Signal Error Event. The options are **Enabled** and Disabled.

### System Error Logging

If this item is set to enabled, an error log will be created when a system error occurs. The options are Enabled and **Disabled**.

### Maximum Payload

Select Auto to allow the system BIOS to automatically set the maximum payload value for a PCI-E device to enhance system performance. The options are **Auto**, 128 Bytes, 256 Bytes, 512 Bytes, 1024 Bytes, 2048 Bytes, and 4096 Bytes.

**Maximum Read Request**

Select Auto to allow the system BIOS to automatically set the maximum Read Request size for a PCI-E device to enhance system performance. The options are **Auto**, 128 Bytes, 256 Bytes, 512 Bytes, 1024 Bytes, 2048 Bytes, and 4096 Bytes.

**ASPM Support**

This feature allows the user to set the Active State Power Management (ASPM) level for a PCI-E device. Select Force L0 to force all PCI-E links to operate at L0 state. Select Auto to allow the system BIOS to automatically set the ASPM level for the system. Select Disabled to disable ASPM support. The options are **Disabled**, Force L0, and Auto.

**Warning:** Enabling ASPM support may cause some PCI-E devices to fail!

**Above 4G Decoding (Available if the system supports 64-bit PCI decoding)**

Select Enabled to decode a 64-bit PCI device in the space above 4G Address. The options are Enabled and **Disabled**.

**Launch Storage OPROM Policy**

This feature controls how the system executes UEFI (Unified Extensible Firmware Interface), and legacy storage OPROM. Select Legacy Only to boot the system using a legacy storage device. The options are Do Not Use, UEFI Only **Legacy Only**, Legacy First, UEFI First.

**PCIe Slot 1 OPROM**

Select Enabled to enable Option ROM support to boot the computer using a network interface device install in the slot specified above. The options are **Enabled** and Disabled.

**Launch Video OPROM Policy**

This feature controls how the system executes UEFI (Unified Extensible Firmware Interface) and video device OPROM. Select Legacy Only to boot the system using a legacy device installed in a video port. The options are Do Not Use, UEFI Only **Legacy Only**, Legacy First, UEFI First.

**VGA Priority**

This feature allows the user to select the graphics adapter to be used as the primary boot device. The options are **Onboard**, and Offboard.

**Launch Network OPROM Policy**

This feature controls how the system executes UEFI (Unified Extensible Firmware Interface) and LAN device OPROM. Select Legacy Only to boot the system using

a legacy device installed in a LAN port. The options are Do Not Use, UEFI Only **Legacy Only**, Legacy First, UEFI First.

#### **Onboard LAN Option ROM Select**

Select iSCSI to use the iSCSI Option ROM to boot the computer using a network device. Select PXE (Preboot Execution Environment) to use an PXE Option ROM to boot the computer using a network device. The options are iSCSI and **PXE**.

#### **Load Onboard LAN1 Option ROM/Load Onboard LAN2 Option ROM**

Select Enabled to enable the onboard LAN1 Option ROM~LAN4 Option ROM. This is to boot the computer using a network device. The default setting for LAN1 Option ROM is **Enabled**, and the default settings for LAN2 Option ROM/LAN3 Option ROM/LAN4 Option ROM are **Disabled**.

### **►ACPI Settings**

#### **WHEA Support**

This feature Enables the Windows Hardware Error Architecture (WHEA) support for the Windows 2008 (or a later vision) operating system. The options are **Enabled** and Disabled.

### **►Super IO Configuration**

#### **Super IO Chip AST2400**

#### **►Serial Port 0 Configuration /Serial Port 1 Configuration**

This submenu allows the user the configure settings of Serial Port 1 or Serial Port 2.

#### **Serial Port**

Select Enabled to enable the a selected onboard serial port. The options are **Enabled** and Disabled.

#### **Device Settings**

This item displays the status of a serial part specified by the user.

#### **Change Settings**

This feature specifies the base I/O port address and the Interrupt Request address of a serial port specified by the user. Select Auto to allow the BIOS to automatically assign the base I/O and IRQ address.

The options for Serial Port 1 are **Auto**, (IO=3F8h; IRQ=4), (IO=3F8h; IRQ=3, 4, 5, 6, 7, 9, 10, 11, 12), (IO=2F8h; IRQ=3, 4, 5, 6, 7, 9, 10, 11, 12), (IO=3E8h; IRQ=3, 4, 5, 6, 7, 9, 10, 11, 12) and (IO=2E8h; IRQ=3, 4, 5, 6, 7, 9, 10, 11, 12).

The options for Serial Port 2 are **Auto**, (IO=2F8h; IRQ=3), (IO=3F8h; IRQ=3, 4, 5, 6, 7, 9, 10, 11, 12), (IO=2F8h; IRQ=3, 4, 5, 6, 7, 9, 10, 11, 12), (IO=3E8h; IRQ=3, 4, 5, 6, 7, 9, 10, 11, 12) and (IO=2E8h; IRQ=3, 4, 5, 6, 7, 9, 10, 11, 12).

### **Device Mode**

Use this feature to set the optimal setting for a super I/O device. The options are **24MHz/13** and **24MHz**.

### **Serial Port 2 Attribute (Available for Serial Port 2 only)**

This feature specifies the attribute of Serial Port 2. The options are **SOL** and **COM**.

## **►Serial Port Console Redirection**

### **COM1 Console Redirection, COM2/SOL Console Redirection**

#### **Console Redirection**

Select **Enabled** to enable console redirection support for a serial port specified by the user. The options are **Enabled** and **Disabled**.

## **►Console Redirection Settings**

This feature allows the user to specify how the host computer will exchange data with the client computer, which is the remote computer used by the user.

#### **Terminal Type**

This feature allows the user to select the target terminal emulation type for Console Redirection. Select **VT100** to use the ASCII Character set. Select **VT100+** to add color and function key support. Select **ANSI** to use the Extended ASCII Character Set. Select **VT-UTF8** to use UTF8 encoding to map Unicode characters into one or more bytes. The options are **ANSI**, **VT100**, **VT100+**, and **VT-UTF8**.

#### **Bits Per second**

Use this feature to set the transmission speed for a serial port used in Console Redirection. Make sure that the same speed is used in the host computer and the client computer. A lower transmission speed may be required for long and busy lines. The options are **9600**, **19200**, **38400**, **57600** and **115200** (bits per second).

#### **Data Bits**

Use this feature to set the data transmission size for Console Redirection. The options are **7 Bits** and **8 Bits**.

### Parity

A parity bit can be sent along with regular data bits to detect data transmission errors. Select Even if the parity bit is set to 0, and the number of 1's in data bits is even. Select Odd if the parity bit is set to 0, and the number of 1's in data bits is odd. Select None if you do not want to send a parity bit with your data bits in transmission. Select Mark to add a mark as a parity bit to be sent along with the data bits. Select Space to add a Space as a parity bit to be sent with your data bits. The options are **None**, Even, Odd, Mark and Space.

### Stop Bits

A stop bit indicates the end of a serial data packet. Select 1 Stop Bit for standard serial data communication. Select 2 Stop Bits if slower devices are used. The options are **1** and 2.

### Flow Control

Use this feature to set the flow control for Console Redirection to prevent data loss caused by buffer overflow. Send a "Stop" signal to stop sending data when the receiving buffer is full. Send a "Start" signal to start sending data when the receiving buffer is empty. The options are **None** and Hardware RTS/CTS.

### VT-UTF8 Combo Key Support

Select Enabled to enable VT-UTF8 Combination Key support for ANSI/VT100 terminals. The options are **Enabled** and Disabled.

### Recorder Mode

Select Enabled to capture the data displayed on a terminal and send it as text messages to a remote server. The options are **Disabled** and Enabled.

### Resolution 100x31

Select Enabled for extended-terminal resolution support. The options are Disabled and **Enabled**.

### Legacy OS Redirection Resolution

Use this feature to select the number of rows and columns used in Console Redirection for legacy OS support. The options are 80x24 and **80x25**.

### Putty KeyPad

This feature selects the settings for Function Keys and KeyPad used for Putty, which is a terminal emulator designed for the Windows OS. The options are **VT100**, LINUX, XTERMR6, SC0, ESCN, and VT400.

### **Redirection After BIOS Post**

Use this feature to enable or disable legacy console redirection after BIOS POST. When set to Bootloader, legacy console redirection is disabled before booting the OS. When set to Always Enable, legacy console redirection remains enabled when booting the OS. The options are **Always Enable** and Bootloader.

### **Serial Port for Out-of-Band Management/Windows Emergency Management Services (EMS)**

The submenu allows the user to configure Console Redirection settings to support Out-of-Band Serial Port management.

#### **Console Redirection (for EMS)**

Select Enabled to use a COM Port selected by the user for Console Redirection. The options are Enabled and **Disabled**.

#### **► Console Redirection Settings (for EMS)**

This feature allows the user to specify how the host computer will exchange data with the client computer, which is the remote computer used by the user.

#### **Out-of-Band Management Port**

The feature selects a serial port used by the Microsoft Windows Emergency Management Services (EMS) to communicate with a remote server. The options are **COM1 Console Redirection** and COM2/SOL Console Redirection.

#### **Terminal Type**

This feature allows the user to select the target terminal emulation type for Console Redirection. Select VT100 to use the ASCII character set. Select VT100+ to add color and function key support. Select ANSI to use the extended ASCII character set. Select VT-UTF8 to use UTF8 encoding to map Unicode characters into one or more bytes. The options are ANSI, VT100, VT100+, and **VT-UTF8**.

#### **Bits Per Second**

This item sets the transmission speed for a serial port used in Console Redirection. Make sure that the same speed is used in the host computer and the client computer. A lower transmission speed may be required for long and busy lines. The options are 9600, 19200, 57600, and **115200** (bits per second).

### Flow Control

This feature allows the user to set the flow control for Console Redirection to prevent data loss caused by buffer overflow. Send a "Stop" signal to stop sending data when the receiving buffer is full. Send a "Start" signal to start sending data when the receiving buffer is empty. The options are **None**, Hardware RTS/CTS, and Software Xon/Xoff.

### Data Bits, Parity, Stop Bits

The status of each item above is displayed.

## ►iSCSI Configuration

When sharing the iSCSI devices on this machine (iSCSI target), this section is used to enter the worldwide unique name of an iSCSI initiator. An iSCSI initiator application must be configured on the machine that will access the iSCSI drives in this machine. **Note:** This section will only appear if the Intel iSCSI driver is integrated into the BIOS..

### iSCSI Initiator Name

Only IQN (iSCSI Qualified Names) names are accepted. Please research RFC 3720 and RFC 3721 at the Internet Engineering Task Force website (IETF -- [www.ietf.org](http://www.ietf.org)) for more information on iSCSI.

### Add an Attempt

The settings on this section are setup parameters to connect to a remote iSCSI device.

**iSCSI Attempt Name** - assigns a unique name to this attempt.

**iSCSI Mode** - select Enabled or **Disabled**.

**Internet Protocol** - select **IP4**, IP6 or Autoconfigure.

**Connection Retry Count** - if the initial connection fails or times out, this is how many times an attempt will be made to connect.

**Connection Establishing Timeout** - This is the time in milliseconds the system will wait for a connection until it times out. The minimum is 100ms and the maximum is 20 secs.

**ISID** - This is the OUI-format ISID. The default value is taken from the device's MAC address. Only the last 3 bytes are configurable.

**Enable DHCP** - Select Enabled to allow a DHCP server to assign the IP addresses for this attempt. If this is set to **Disabled**, then you need to manually enter the Initiator IP Address, Initiator Subnet Mask and Gateway.



**Get target info via DHCP** - select Enabled to allow the system to retrieve the target device information through the DHCP server. The options are Enabled and **Disabled**

**Target Name** - Enter the qualified domain name of the target iSCSI device.

**Target IP Address** - Enter the IP Address of the target iSCSI device.

**Target Port** - Enter the port address of the target iSCSI device.

**Boot LUN** - This is the target's LU number in Hexadecimal format.

**Authentication Type** - Select **CHAP** or None.

If CHAP is selected above:

**CHAP Type** - Select **One Way** or Mutual.

**CHAP Name** - Assign a name for this authentication.

**CHAP Secret** - Assign a secret word that is also defined in the target iSCSI device. Minimum length is 12 bytes and maximum is 16 bytes.

When finished, select Save Changes and select Back to Previous Page.

### **Delete Attempts**

This feature deletes previously defined attempts as above.

### **Change Attempt Order**

This feature changes the order in which several iSCSI connection attempts are made.

## 4-4 IPMI

Use this feature to configure Intelligent Platform Management Interface (IPMI) settings.

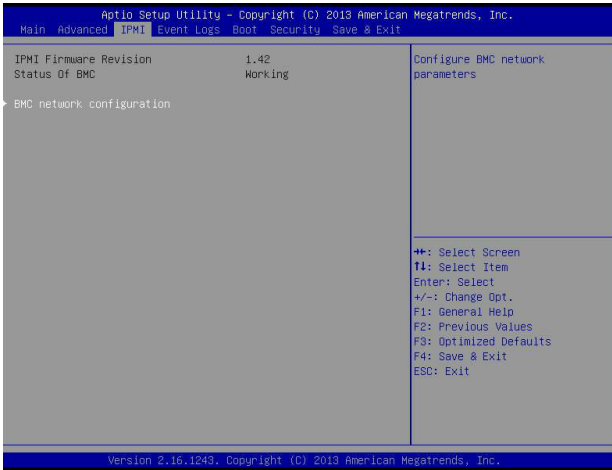

### IPMI Firmware Revision

This item indicates the IPMI firmware revision used in your system.

### Status BMC (Baseboard Management Cont

This item indicates the status of the IPMI firmware installed in your system.

## ►BMC Network Configuration

### BMC Network Congifuration

**LAN Channel 1:** This feature allows the user to configure the setting for LAN Port 1.

### Configuration Address Source

This feature allows the user to select the source of the IP address for this computer. If Static is selected, you will need to know the IP address of this computer and enter it to the system manually in the field. If DHCP is selected, the BIOS will search for a DHCP (Dynamic Host Configuration Protocol) server in the network that is attached to and request the next available IP address for this computer. The options are **DHCP** and Static. The following items are assigned IP addresses automatically if DHCP is selected.

**Station IP Address**

This item displays the Station IP address for this computer. This should be in decimal and in dotted quad form (i.e., 192.168.10.253).

**Subnet Mask**

This item displays the sub-network that this computer belongs to. The value of each three-digit number separated by dots should not exceed 255.

**Station MAC Address**

This item displays the Station MAC address for this computer. Mac addresses are 6 two-digit hexadecimal numbers.

**Router IP Address**

This item displays the Router IP address for this computer. This should be in decimal and in dotted quad form (i.e., 192.168.10.253).

**Router MAC Address**

This item displays the Router MAC address for this computer. Mac addresses are 6 two-digit hexadecimal numbers.

## 4-5 Event Logs



### ► Change SMBIOS Event Log Settings

#### Enabling/Disabling Options

#### SMBIOS Event Log

Change this item to enable or disable all features of the SMBIOS Event Logging during system boot. The options are **Enabled** and Disabled.

#### Erasing Settings

#### Erase Event Log

If No is selected, data stored in the event log will not be erased. Select Yes, Next Reset, data in the event log will be erased upon next system reboot. Select Yes, Every Reset, data in the event log will be erased upon every system reboot. The options are **No**, Yes, Next reset, and Yes, Every reset.

#### When Log is Full

Select Erase Immediately for all messages to be automatically erased from the event log when the event log memory is full. The options are **Do Nothing** and Erase Immediately.

#### SMBIOS Event Long Standard Settings

#### Log System Boot Event

This option toggles the System Boot Event logging to enabled or disabled. The options are **Disabled** and Enabled.

**MECI**

The Multiple Event Count Increment (MECI) counter counts the number of occurrences that a duplicate event must happen before the MECI counter is incremented. This is a numeric value. The default value is **1**.

**METW**

The Multiple Event Time Window (METW) defines number of minutes must pass between duplicate log events before MECI is incremented. This is in minutes, from 0 to 99. The default value is **60**.

**Customer Options****Log OEM Codes**

Select Enabled to log the status of OEM EFI codes. The options are **Enabled** and Disabled.

**Convert OEM Codes**

Select Enabled to convert the OEM Status codes to the standard SMBIOS codes. The options are Enabled and **Disabled**.

## 4-6 Boot

Use this feature to configure Boot Settings:

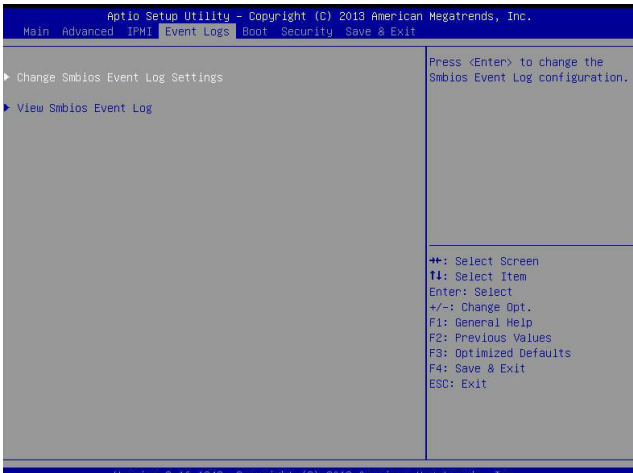

### Boot Option Priorities

This option prioritizes the order of bootable devices that the system to boot from. Press [ENTER] on each entry from top to bottom to select devices.

- Boot Option #1
- Boot Option #2

### ▶ Delete Boot Option

Choose this option to remove an EFI boot option from the boot order. Please <Enter> and choose the option to delete from the list.

### ▶ Delete Driver Option

Choose this option to remove an EFI driver option from the driver order. Please <Enter> and choose the option to delete from the list.

## 4-7 Security

This menu allows the user to configure the following security settings for the system.

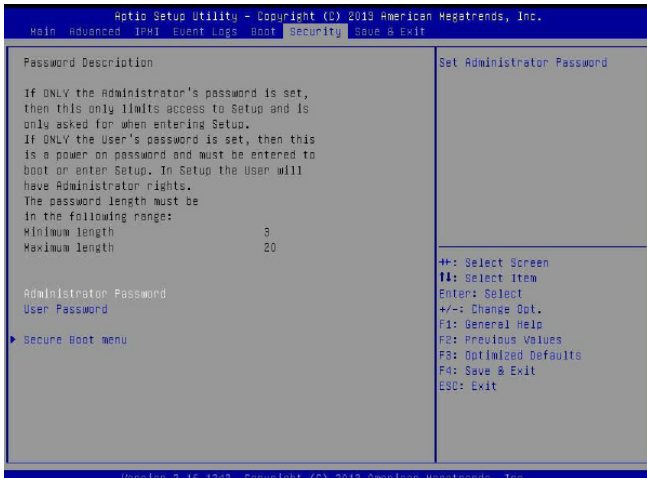

- If the Administrator password is defined ONLY - this controls access to the BIOS setup ONLY.
- If the User's password is defined ONLY - this password will need to be entered upon each system boot, and will also have Administrator rights in the setup.
- Passwords must be at least 3 and up to 20 characters long.

### Administrator Password

Press Enter to create a new, or change an existing Administrator password.

### User Password

Use this feature to set a User Password which is required to log into the system and to enter the BIOS setup utility. The length of the password should be from 3 characters to 20 characters long.

## ►Secure Boot Menu

This section displays the contents of the following secure boot features:

- System Mode
- Secure Boot

### Secure Boot Mode

Use this item to select the secure boot mode. The options are **Standard** and Custom.

## ►Key Management

This submenu allows the user to configure the following Key Management settings.

### Default Key Provision

Select Enabled to install the default Secure-Boot keys set by the manufacturer. The options are **Disabled** and Enabled.

#### ►Enroll All Factory Default Keys

Select Yes to install all default secure keys set by the manufacturer. The options are **Yes** and No.

#### Save All Secure Boot Variables

This feature allows the user to decide if all secure boot variables should be saved.

### Platform Key (PK)

This feature allows the user to configure the settings of the platform keys.

#### ►Delete PK (Platform Keys)

This feature allows the user to configure the settings for platform keys deletion.

#### ►Set New PK (Platform Keys)

Select Yes to load the new platform keys from the manufacturer's defaults. Select No to load the platform keys from a file. The options are **Yes** and No.



---

## Key Exchange Key (KEK)

### ► Delete KEK

Select Yes to delete a previously set Key Exchange Key. The options are **Yes** and No.

### ► Set New KEK

Select Yes to load the KEK from the manufacturer's defaults. Select No to load the KEK from a file. The options are **Yes** and No.

### ► Append Key Exchange Key (KEK)

Select Yes to add the KEK from the manufacturer's defaults list to the existing KEK. Select No to load the KEK from a file. The options are **Yes** and No.

## Authorized Signatures (DB)

### ► Delete DB

Select Yes to delete a previously set Authorized Signature. The options are **Yes** and No.

### ► Set New DB

Select Yes to load the database from the manufacturer's defaults. Select No to load the DB from a file. The options are **Yes** and No.

### ► Append DB

Select Yes to add the database from the manufacturer's defaults to the existing DB. Select No to load the DB from a file. The options are **Yes** and No.

## Authorized Time Stamps

### ► Delete DBT

Select Yes to delete a previously set DBT. The options are **Yes** and No.

### ► Set New DBT

Select Yes to load the DBT from the manufacturer's defaults. Select No to load the DBT from a file. The options are **Yes** and No.

### ► Append DBT

Select Yes to add the DBT from the manufacturer's defaults to the existing DBT. Select No to load the DBT from a file. The options are **Yes** and No.

### Forbidden Signature Database (DBX)

#### ▶ Delete DBX

Select Yes to delete a previously set DBX. The options are **Yes** and No.

#### ▶ Set New DBX

Select Yes to load the DBX from the manufacturer's defaults. Select No to load the DBX from a file. The options are **Yes** and No.

#### ▶ Append DBX

Select Yes to add the DBX from the manufacturer's defaults to the existing DBX. Select No to load the DBX from a file. The options are **Yes** and No.

## 4-8 Save & Exit

Select the Exit tab from the BIOS setup utility screen to enter the Exit BIOS Setup screen.

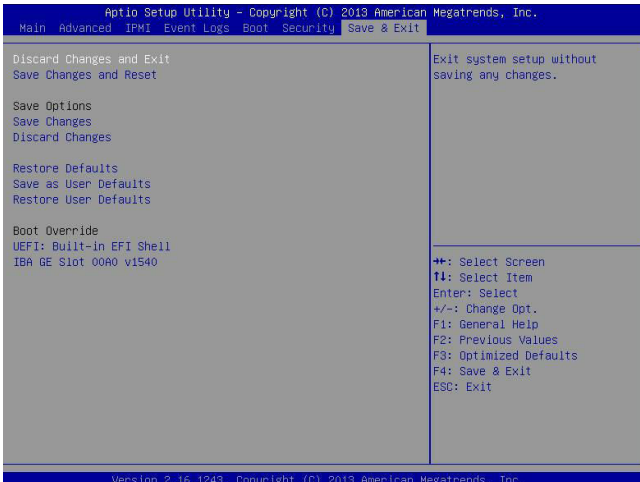

### Discard Changes and Exit

Select this option to quit the BIOS Setup without making any permanent changes to the system configuration, and reboot the computer. Select Discard Changes and Exit from the Exit menu and press <Enter>.

### Save Changes and Reset

When you have completed the system configuration changes, select this option to leave the BIOS setup utility and reboot the computer, so the new system configuration parameters can take effect. Select Save Changes and Exit from the Exit menu and press <Enter>.

### Save Options

### Save Changes

After completing the system configuration changes, select this option to save the changes you have made. This will not reset (reboot) the system.

### Discard Changes

Select this option and press <Enter> to discard all the changes and return to the AMI BIOS utility Program.

### **Restore Defaults**

To set this feature, select Restore Defaults from the Save & Exit menu and press <Enter>. These are factory settings designed for maximum system stability, but not for maximum performance.

### **Save As User Defaults**

To set this feature, select Save as User Defaults from the Exit menu and press <Enter>. This enables the user to save any changes to the BIOS setup for future use.

### **Restore User Defaults**

To set this feature, select Restore User Defaults from the Exit menu and press <Enter>. Use this feature to retrieve user-defined settings that were saved previously.

### **Boot Override**

Listed on this section are other boot options for the system (i.e., Built-in EFI shell). Select an option and press <Enter>. Your system will boot to the selected boot option.

---

---

## Appendix A

### BIOS Error Beep Codes

During the POST (Power-On Self-Test) routines, which are performed each time the system is powered on, errors may occur.

**Non-fatal errors** are those which, in most cases, allow the system to continue with bootup. The error messages normally appear on the screen.

**Fatal errors** will not allow the system to continue to bootup. If a fatal error occurs, you should consult with your system manufacturer for possible repairs.

These fatal errors are usually communicated through a series of audible beeps. The numbers on the fatal error list correspond to the number of beeps for the corresponding error.

#### A-1 BIOS Error Beep Codes

BIOS Error Beep Codes		
Beep Code/LED	Error Message	Description
1 beep	Refresh	Circuits have been reset. (Ready to power up)
5 short beeps + 1 long beep	Memory error	No memory detected in the system
8 beeps	Display memory read/write error	Video adapter missing or with faulty memory
OH LED On	System OH	System Overheat

## **Notes**

## Appendix B

### Software Installation Instructions

#### B-1 Installing Software Programs

The Supermicro ftp site contains drivers and utilities for your system at <ftp://ftp.supermicro.com>. Some of these must be installed, such as the chipset driver.

After accessing the ftp site, go into the CDR\_Images directory and locate the ISO file for your motherboard. Download this file to create a CD/DVD of the drivers and utilities it contains. (You may also use a utility to extract the ISO file if preferred.)

Another option is to go to the Supermicro Website at <http://www.supermicro.com/products/>. Find the product page for your motherboard here, where you may download individual drivers and utilities.

After creating a CD/DVD with the ISO files, insert the disk into the CD/DVD drive on your system and the display shown below should appear.

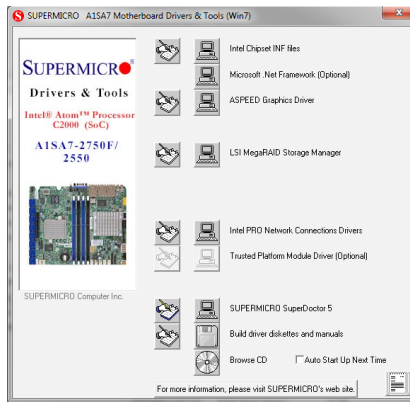

**Driver/Tool Installation Display Screen**

**Note 1:** Click the icons showing a hand writing on paper to view the readme files for each item. Click the computer icons to the right of these items to install each item (from top to the bottom) one at a time. **After installing each item, you must re-boot the system before moving on to the next item on the list.** The bottom icon with a CD on it allows you to view the entire contents.

**Note 2:** When making a storage driver diskette by booting into a Driver CD, please set the SATA Configuration to "Compatible Mode" and configure SATA as IDE in the BIOS Setup. After making the driver diskette, be sure to change the SATA settings back to your original settings.

## B-2 Installing SuperDoctor5

The Supermicro SuperDoctor® 5 is a hardware monitoring program that functions in a command-line or web-based interface in Windows and Linux operating systems. The program monitors system health information such as CPU temperature, system voltages, system power consumption, fan speed, and provides alerts via email or Simple Network Management Protocol (SNMP).

SuperDoctor 5 comes in local and remote management versions and can be used with Nagios to maximize your system monitoring needs. With SuperDoctor 5 Management Server (SSM Server), you can remotely control power on/off and reset chassis intrusion for multiple systems with SuperDoctor 5 or IPMI. SD5 Management Server monitors HTTP, FTP, and SMTP services to optimize the efficiency of your operation.

 **Note:** The default User Name and Password for SuperDoctor 5 is admin /admin.

### SuperDoctor 5 Interface Display Screen (Health Information)

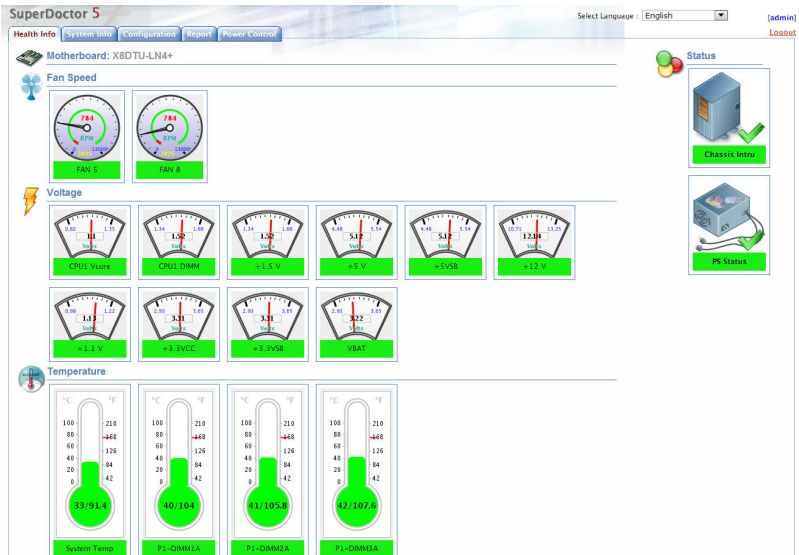

 **Note:** The SuperDoctor 5 program and User's Manual can be downloaded from the Supermicro web site at [http://www.supermicro.com/products/nfo/sms\\_sd5.cfm](http://www.supermicro.com/products/nfo/sms_sd5.cfm).



## Appendix C

### UEFI BIOS Recovery Instructions

**Warning:** Do not upgrade the BIOS unless your system has a BIOS-related issue. Flashing the wrong BIOS can cause irreparable damage to the system. In no event shall Supermicro be liable for direct, indirect, special, incidental, or consequential damages arising from a BIOS update. If you need to update the BIOS, do not shut down or reset the system while the BIOS is updating to avoid possible boot failure.

#### C-1 An Overview to the UEFI BIOS

The Unified Extensible Firmware Interface (UEFI) specification provides a software-based interface between the operating system and the platform firmware in the pre-boot environment. The UEFI specification supports an architecture-independent mechanism for add-on card initialization to allow the UEFI OS loader, which is stored in the add-on card, to boot up the system. UEFI offers a clean, hands-off control to a computer system at bootup.

#### C-2 How to Recover the UEFI BIOS Image (-the Main BIOS Block)

A UEFI BIOS flash chip consists of a recovery BIOS block, comprised of two boot blocks and a main BIOS block (a main BIOS image). The boot block contains critical BIOS codes, including memory detection and recovery codes for the user to flash a new BIOS image if the original main BIOS image is corrupted. When the system power is on, the boot block codes execute first. Once that is completed, the main BIOS code will continue with system initialization and bootup.



**Note:** Follow the BIOS Recovery instructions below for BIOS recovery when the main BIOS boot crashes. However, when the BIOS boot block crashes, you will need to follow the procedures in Appendix D.

#### C-3 To Recover the Main BIOS Block Using a USB-Attached Device

This feature allows the user to recover a BIOS image using a USB-attached device without additional utilities used. A USB flash device such as a USB Flash Drive, or a USB CD/DVD ROM/RW device can be used for this purpose. However, a USB Hard Disk drive cannot be used for BIOS recovery at this time.

To perform UEFI BIOS recovery using a USB-attached device, follow the instructions below.

1. Using a different machine, copy the "Super.ROM" binary image file into the disc Root "\" Directory of a USB device or a writeable CD/DVD.

 **Note:** If you cannot locate the "Super.ROM" file in your driver disk, visit our website at [www.supermicro.com](http://www.supermicro.com) to download the BIOS image into a USB flash device and rename it "Super ROM" for BIOS recovery use.

2. Insert the USB device that contains the new BIOS image ("Super.ROM") into your USB drive and power on the system
3. While powering on the system, keep pressing <Ctrl> and <Home> simultaneously on your keyboard until you hear two short beeps. This may take from a few seconds to one minute.
4. After locating the new BIOS binary image, the system will enter the BIOS Recovery menu as shown below.

 **Note:** At this point, you may decide if you want to start with BIOS Recovery. If you decide to proceed with BIOS Recovery, follow the procedures below.

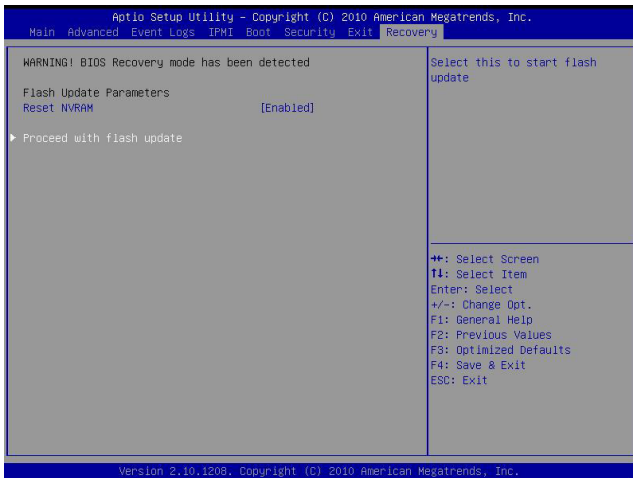

5. When the screen as shown above displays, using the arrow key, select the item- "Proceed with flash update" and press the <Enter> key. You will see the progress of BIOS Recovery as shown in the screen below.

 **Note:** Do not interrupt the process of BIOS flashing until it is completed.

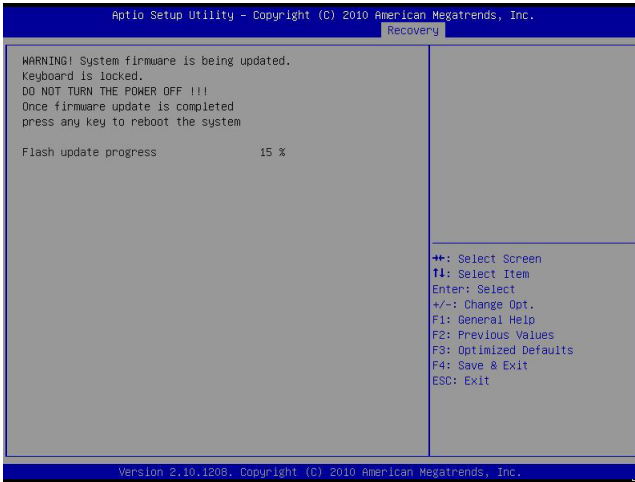

- After the process of BIOS Recovery is complete, press any key to reboot the system.

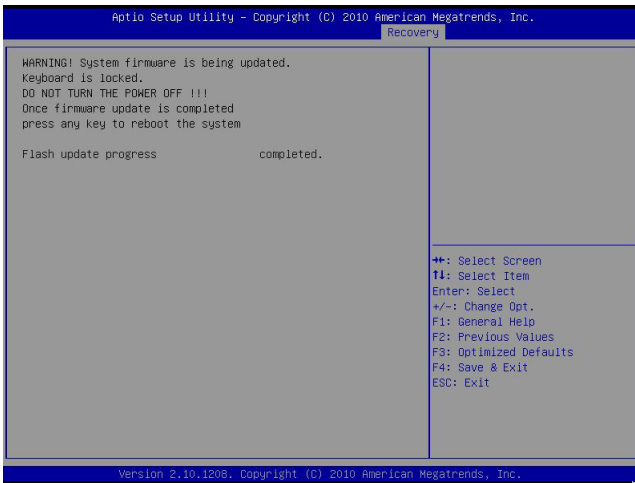

- Using a different system, extract the BIOS package into a bootable USB flash drive.
- When a DOS prompt appears, enter `AMI.BAT BIOSname.###` at the prompt.



**Note:** Do not interrupt this process until BIOS flashing is completed.

9. After seeing the message that BIOS update is completed, unplug the AC power cable from the power supply to clear CMOS, and then plug the AC power cable in the power supply again to power on the system.
10. Press <Del> continuously to enter the BIOS Setup utility.
11. Press <F3> to load default settings.
12. After loading default settings, press <F4> to save the settings and exit the BIOS Setup utility.

(Disclaimer Continued)

The products sold by Supermicro are not intended for and will not be used in life support systems, medical equipment, nuclear facilities or systems, aircraft, aircraft devices, aircraft/emergency communication devices or other critical systems whose failure to perform be reasonably expected to result in significant injury or loss of life or catastrophic property damage. Accordingly, Supermicro disclaims any and all liability, and should buyer use or sell such products for use in such ultra-hazardous applications, it does so entirely at its own risk. Furthermore, buyer agrees to fully indemnify, defend and hold Supermicro harmless for and against any and all claims, demands, actions, litigation, and proceedings of any kind arising out of or related to such ultra-hazardous use or sale.