



X10SDV

Mini-ITX Series

USER'S MANUAL

1.0b

The information in this user's manual has been carefully reviewed and is believed to be accurate. The vendor assumes no responsibility for any inaccuracies that may be contained in this document, and makes no commitment to update or to keep current the information in this manual, or to notify any person or organization of the updates. **Please Note: For the most up-to-date version of this manual, please see our website at www.supermicro.com.**

Super Micro Computer, Inc. ("Supermicro") reserves the right to make changes to the product described in this manual at any time and without notice. This product, including software and documentation, is the property of Supermicro and/or its licensors, and is supplied only under a license. Any use or reproduction of this product is not allowed, except as expressly permitted by the terms of said license.

IN NO EVENT WILL SUPER MICRO COMPUTER, INC. BE LIABLE FOR DIRECT, INDIRECT, SPECIAL, INCIDENTAL, SPECULATIVE OR CONSEQUENTIAL DAMAGES ARISING FROM THE USE OR INABILITY TO USE THIS PRODUCT OR DOCUMENTATION, EVEN IF ADVISED OF THE POSSIBILITY OF SUCH DAMAGES. IN PARTICULAR, SUPER MICRO COMPUTER, INC. SHALL NOT HAVE LIABILITY FOR ANY HARDWARE, SOFTWARE, OR DATA STORED OR USED WITH THE PRODUCT, INCLUDING THE COSTS OF REPAIRING, REPLACING, INTEGRATING, INSTALLING OR RECOVERING SUCH HARDWARE, SOFTWARE, OR DATA.

Any disputes arising between the manufacturer and the customer shall be governed by the laws of Santa Clara County in the State of California, USA. The State of California, County of Santa Clara shall be the exclusive venue for the resolution of any such disputes. Supermicro's total liability for all claims will not exceed the price paid for the hardware product.

FCC Statement: This equipment has been tested and found to comply with the limits for a Class A digital device pursuant to Part 15 of the FCC Rules. These limits are designed to provide reasonable protection against harmful interference when the equipment is operated in a commercial environment. This equipment generates, uses, and can radiate radio frequency energy and, if not installed and used in accordance with the manufacturer's instruction manual, may cause harmful interference with radio communications. Operation of this equipment in a residential area is likely to cause harmful interference, in which case you will be required to correct the interference at your own expense.

California Best Management Practices Regulations for Perchlorate Materials: This Perchlorate warning applies only to products containing CR (Manganese Dioxide) Lithium coin cells. "Perchlorate Material-special handling may apply. See www.dtsc.ca.gov/hazardouswaste/perchlorate".

WARNING: Handling of lead solder materials used in this product may expose you to lead, a chemical known to the State of California to cause birth defects and other reproductive harm.

Manual Revision: 1.0b

Release Date: February 17, 2016

Unless you request and receive written permission from Super Micro Computer, Inc., you may not copy any part of this document.

Information in this document is subject to change without notice. Other products and companies referred to herein are trademarks or registered trademarks of their respective companies or mark holders.

Copyright © 2016 by Super Micro Computer, Inc.

All rights reserved.

Printed in the United States of America

Preface

This manual is written for system integrators, IT technicians and knowledgeable end users. It provides information for the installation and use of the **SUPER** X10SDV Mini-ITX Series motherboard.

About This Motherboard

The **SUPER** X10SDV Mini-ITX Series motherboard supports an Intel® Xeon® D-1500 series SoC (System-on-a-Chip) processor in a BGA package. The X10SDV Mini-ITX motherboard addresses a low-power, high-density infrastructure need with either 4/6/8/12/16 Xeon cores, up to 128 GB of addressable memory, two integrated 10 Gigabit Intel Ethernet ports*, two 1 Gigabit Intel Ethernet ports*, M.2 SSD, Intel Rapid Storage Technology Enterprise (RSTe), USB 3.0 and a thermal design from 35 to 65 watts only. The X10SDV Mini-ITX Series motherboards provide software consistency from the data center to the storage and network edge with the same instruction set as the robust Xeon processor.

Please refer to our website at (<http://www.supermicro.com/products/>) for memory support updates. This product is intended to be installed and serviced by professional technicians.

Manual Organization

Chapter 1 describes the features, specifications and performance of the motherboard, and provides detailed information on the Intel Xeon D-1500 Series processor.

Chapter 2 provides hardware installation instructions. Read this chapter when installing the processor, memory modules and other hardware components into the system. If you encounter any problems, see **Chapter 3**, which describes troubleshooting procedures for video, memory and system setup stored in the CMOS.

Chapter 4 includes an introduction to the BIOS, and provides detailed information on running the CMOS Setup utility.

Appendix A provides BIOS Error Beep Codes.

Appendix B lists software program installation instructions.

Appendix C contains UEFI BIOS Recovery instructions.

Appendix D contains Dual Boot Block instructions.

*** 1G and 10G Ethernet port availability varies by model. Please refer to the variation table on page 1-9.**

Conventions Used in the Manual:

Special attention should be given to the following symbols for proper installation and to prevent damage done to the components or injury to yourself:

Warning: Critical information to prevent damage to the components or injury to yourself.



Important: Important information given to ensure proper system installation or to relay safety precautions.



Note: Additional Information given to differentiate various models or to provide instructions for correct system setup.

Contacting Supermicro

Headquarters

Address: Super Micro Computer, Inc.
980 Rock Ave.
San Jose, CA 95131 U.S.A.

Tel: +1 (408) 503-8000

Fax: +1 (408) 503-8008

Email: marketing@supermicro.com (General Information)
support@supermicro.com (Technical Support)

Web Site: www.supermicro.com

Europe

Address: Super Micro Computer B.V.
Het Sterrenbeeld 28, 5215 ML
's-Hertogenbosch, The Netherlands

Tel: +31 (0) 73-6400390

Fax: +31 (0) 73-6416525

Email: sales@supermicro.nl (General Information)
support@supermicro.nl (Technical Support)
rma@supermicro.nl (Customer Support)

Web Site: www.supermicro.nl

Asia-Pacific

Address: Super Micro Computer, Inc.
3F, No. 150, Jian 1st Rd.
Zhonghe Dist., New Taipei City 235
Taiwan (R.O.C)

Tel: +886-(2) 8226-3990

Fax: +886-(2) 8226-3992

Email: support@supermicro.com.tw

Web Site: www.supermicro.com.tw

Table of Contents

Preface

About This Motherboard.....	iii
Manual Organization	iii
Conventions Used in the Manual:.....	iv
Contacting Supermicro.....	v

Chapter 1 Introduction

1-1 Overview	1-1
Checklist.....	1-1
Motherboard Features.....	1-12
1-2 Processor Overview	1-15
1-3 Special Features	1-16
Recovery from AC Power Loss.....	1-16
1-4 PC Health Monitoring.....	1-16
Environmental Temperature Control	1-16
System Resource Alert	1-16
1-5 ACPI Features.....	1-17
1-6 Power Supply.....	1-17

Chapter 2 Installation

2-1 Standardized Warning Statements	2-1
Battery Handling.....	2-1
Product Disposal	2-3
2-2 Static-Sensitive Devices.....	2-4
Precautions	2-4
Unpacking	2-4
2-3 Motherboard Installation.....	2-5
Tools Needed	2-5
Location of Mounting Holes	2-5
Installing the Motherboard	2-6
2-4 Memory Support.....	2-7
Memory Population Guidelines	2-7
Memory Installation Guidelines.....	2-8
Installing DIMM Memory Modules.....	2-8
Removing DIMM Memory Modules.....	2-8
2-5 Connectors/IO Ports.....	2-9
Back panel I/O Panel.....	2-9
Serial Port.....	2-10
Ethernet Ports	2-11

	Universal Serial Bus (USB).....	2-12
	Unit Identifier Switch	2-13
	VGA.....	2-13
	Front Control Panel.....	2-14
	Front Control Panel Pin Definitions.....	2-15
	Power LED	2-15
	Overheat (OH)/Fan Fail/PWR Fail/UID LED.....	2-15
	HDD LED.....	2-16
	NIC1/NIC2 (LAN1/LAN2).....	2-16
	Reset Button	2-17
	Power Button	2-17
	Power Fail LED (Available on PCB 2.00 only)	2-18
2-6	Connecting Cables.....	2-19
	ATX PWR, DC PWR and HDD PWR Connectors (JPW1, PJ1, J6).....	2-19
	Fan Headers (FAN1 ~ FAN4) (FAN4 is available on PCB 2.00 only).....	2-20
	Chassis Intrusion	2-20
	System Management Bus Header	2-21
	DOM PWR Connector.....	2-21
	TPM Header/Port 80 Header	2-22
	Overheat LED Header.....	2-22
	Speaker	2-23
	Standby Power.....	2-23
	I-SGPIO1/I-SGPIO2	2-24
	NVMe I2C Header.....	2-24
	Power SMBus (I ² C) Connector (available on PCB 2.00 only).....	2-25
	System Management Bus Header	2-25
	GPIO Header.....	2-26
2-7	Jumper Settings	2-27
	Explanation of Jumpers	2-27
	VGA Enable.....	2-27
	CMOS Clear.....	2-28
	PCI-E Slot SMB Enable (I ² C1/I ² C2).....	2-28
	Watch Dog Timer Enable	2-29
	USB Wake-Up	2-29
	Management Engine (ME) Recovery	2-30
	ME Manufacturing Mode.....	2-30
	Gigabit LAN Ports Enable/Disable (on -F, -LN2F, -TLN4F models)	2-31
	10G LAN Ports Enable/Disable (on -TLN2F and -TLN4F models).....	2-31
	BIOS Recovery.....	2-32

2-8	Onboard Indicators.....	2-33
	LAN LEDs.....	2-33
	BMC Heartbeat LED	2-33
	Onboard Power LED	2-34
	Overheat/PWR Fail/Fan Fail LED	2-34
	Unit Identification LED.....	2-35
2-9	SATA Connections.....	2-36
	SATA Ports (I-SATA0 ~ I-SATA5)	2-36
	M.2 Socket	2-36

Chapter 3 Troubleshooting

3-1	Troubleshooting Procedures	3-1
3-2	Technical Support Procedures	3-3
3-3	Frequently Asked Questions	3-4
3-4	Battery Removal and Installation	3-5
3-5	Returning Merchandise for Service.....	3-6

Chapter 4 BIOS

4-1	Introduction.....	4-1
4-2	Main Setup.....	4-2
4-3	Advanced Setup Configurations.....	4-4
4-4	Event Logs	4-27
4-5	IPMI.....	4-29
4-6	Security	4-32
4-7	Boot Settings.....	4-35
4-8	Save & Exit	4-37

Appendix A BIOS Error Beep Codes

A-1	BIOS Error Beep Codes	A-1
-----	-----------------------------	-----

Appendix B Software Installation Instructions

B-1	Installing Software Programs	B-1
B-2	Installing SuperDoctor5.....	B-2

Appendix C UEFI BIOS Recovery Instructions

C-1	An Overview to the UEFI BIOS	C-1
C-2	How to Recover the UEFI BIOS Image (-the Main BIOS Block).....	C-1
C-3	To Recover the Main BIOS Block Using a USB-Attached Device.....	C-1

Appendix D Dual Boot Block

D-1	Introduction.....	D-1
	BIOS Boot Block	D-1
	BIOS Boot Block Corruption Occurrence	D-1
D-2	Steps to Reboot the System by Using Jumper JBR1	D-2

Chapter 1

Introduction

1-1 Overview

Checklist

Congratulations on purchasing your computer motherboard from an acknowledged leader in the industry. Supermicro boards are designed with the utmost attention to detail to provide you with the highest standards in quality and performance.

Please check that the following items have all been included with your motherboard. If anything listed here is damaged or missing, contact your retailer.

The following items are included in the retail box:

- One (1) Supermicro Motherboard
- Six (6) SATA cables
- One (1) I/O shield
- One (1) Quick Reference Guide



Note: For your system to work properly, please follow the links below to download all necessary drivers/utilities and the user's manual for your motherboard.

SMCI product manuals: <http://www.supermicro.com/support/manuals/>

Product Drivers and utilities: <ftp://ftp.supermicro.com/>

If you have any questions, please contact our support team at support@supermicro.com.

SUPER X10SDV-TLN4F Image
SUPER X10SDV-6C+-TLN4F Image
SUPER X10SDV-16C+-TLN4F Image

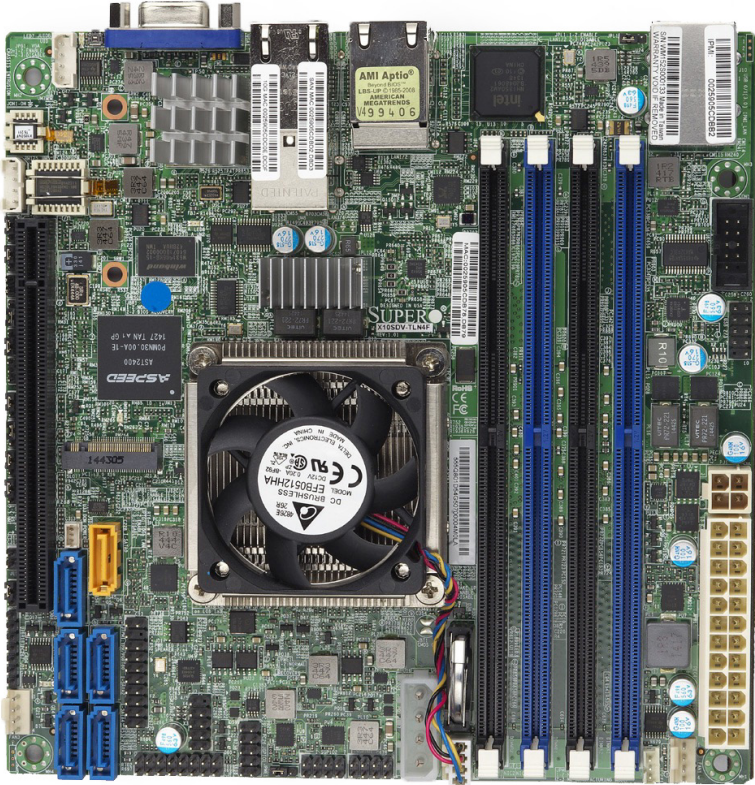

Note: All graphics shown in this manual were based upon the latest PCB Revision available at the time of publishing of the manual. The motherboard you have received may or may not look exactly the same as the graphics shown in this manual.

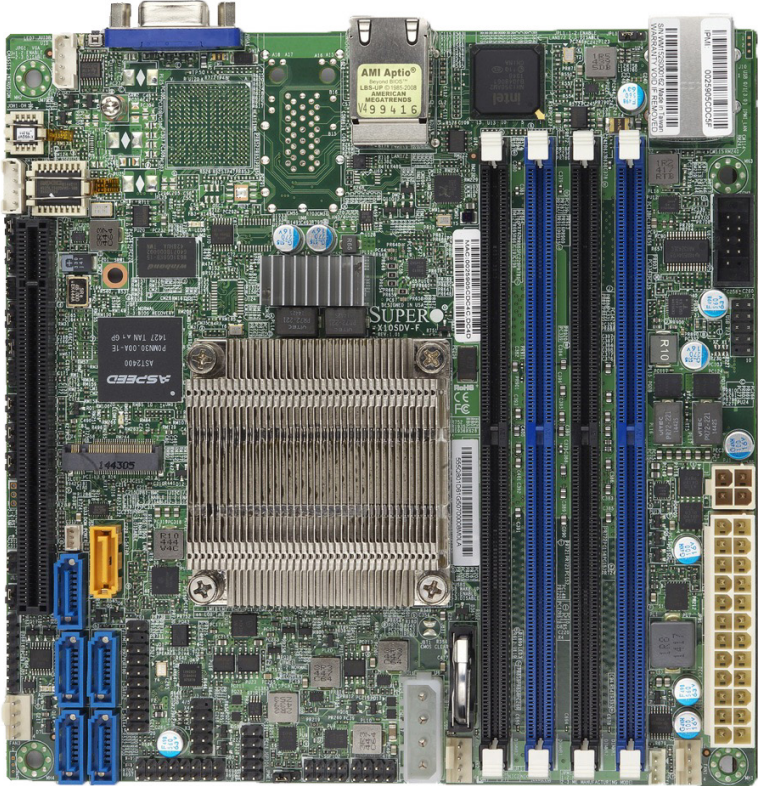
SUPER X10SDV-F Image

 **Note:** All graphics shown in this manual were based upon the latest PCB Revision available at the time of publishing of the manual. The motherboard you have received may or may not look exactly the same as the graphics shown in this manual.

SUPER X10SDV-8C+-LN2F Image

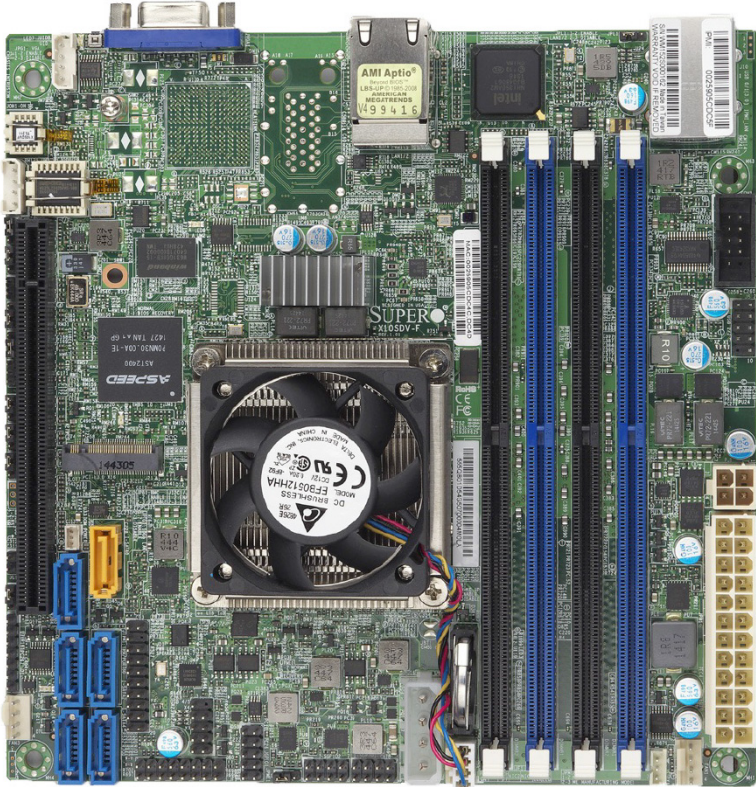

Note: All graphics shown in this manual were based upon the latest PCB Revision available at the time of publishing of the manual. The motherboard you have received may or may not look exactly the same as the graphics shown in this manual.

SUPER X10SDV-4C-TLN2F Image

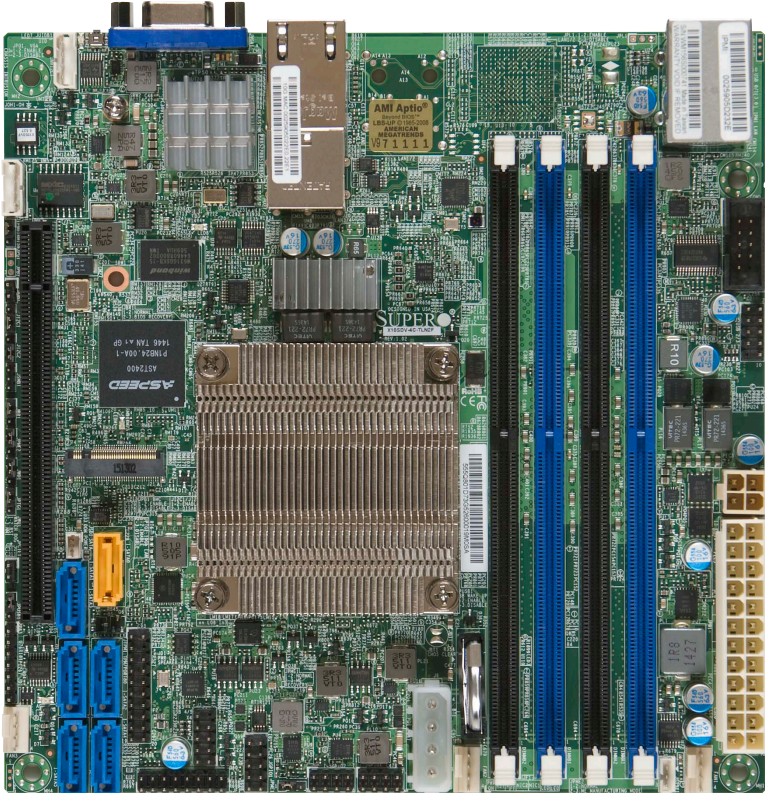

Note: All graphics shown in this manual were based upon the latest PCB Revision available at the time of publishing of the manual. The motherboard you have received may or may not look exactly the same as the graphics shown in this manual.

SUPER X10SDV-4C-TLN4F Image
SUPER X10SDV-6C-TLN4F Image
SUPER X10SDV-8C-TLN4F Image
SUPER X10SDV-12C-TLN4F Image
SUPER X10SDV-16C-TLN4F Image

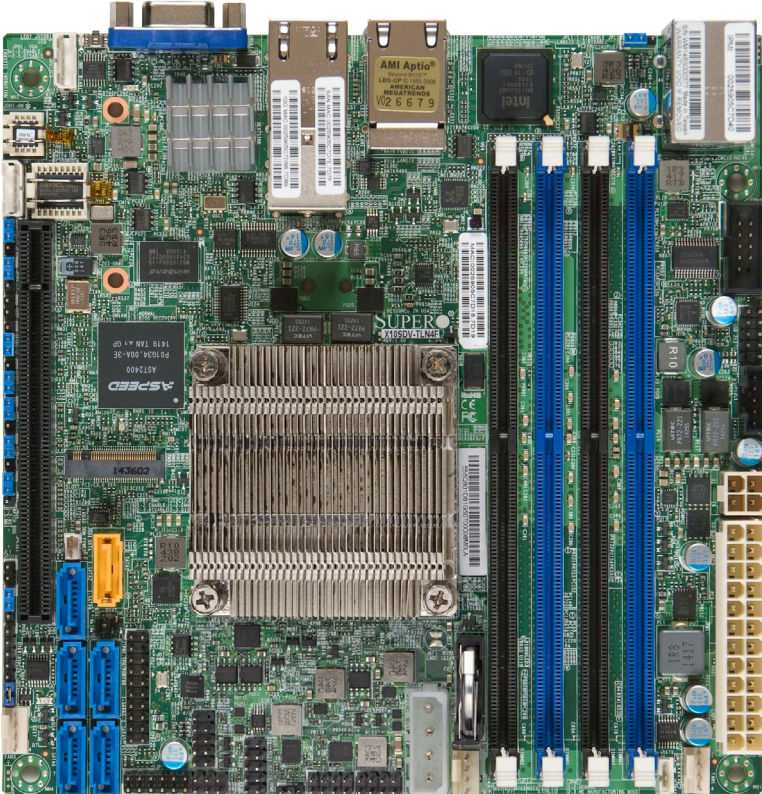

Note: All graphics shown in this manual were based upon the latest PCB Revision available at the time of publishing of the manual. The motherboard you have received may or may not look exactly the same as the graphics shown in this manual.

X10SDV Series Motherboard Layout

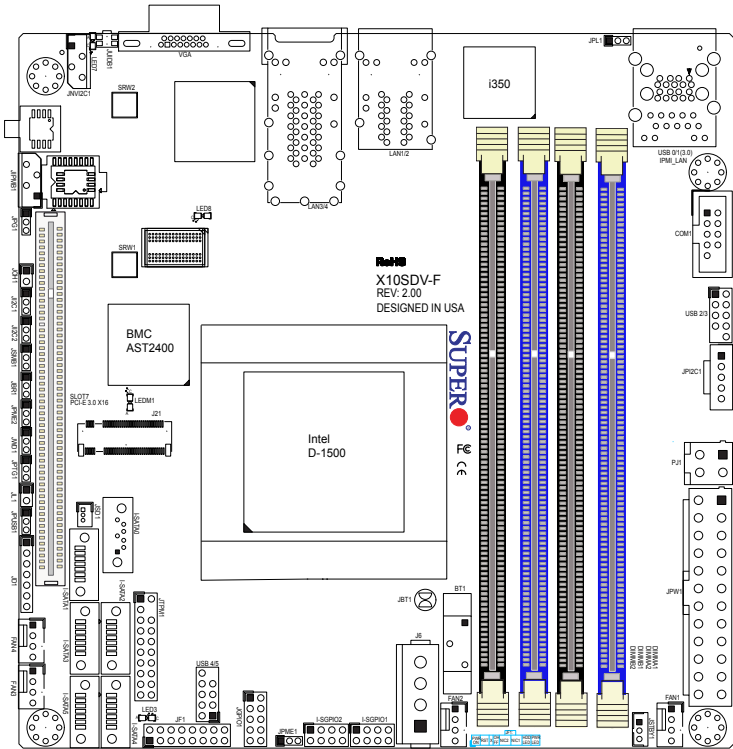

Important Notes to the User

1. See Chapter 2 for detailed information on jumpers, I/O ports and JF1 front panel connections.
2. "■" indicates the location of "Pin 1". Jumpers not indicated are for testing only.

X10SDV Series Motherboard Quick Reference

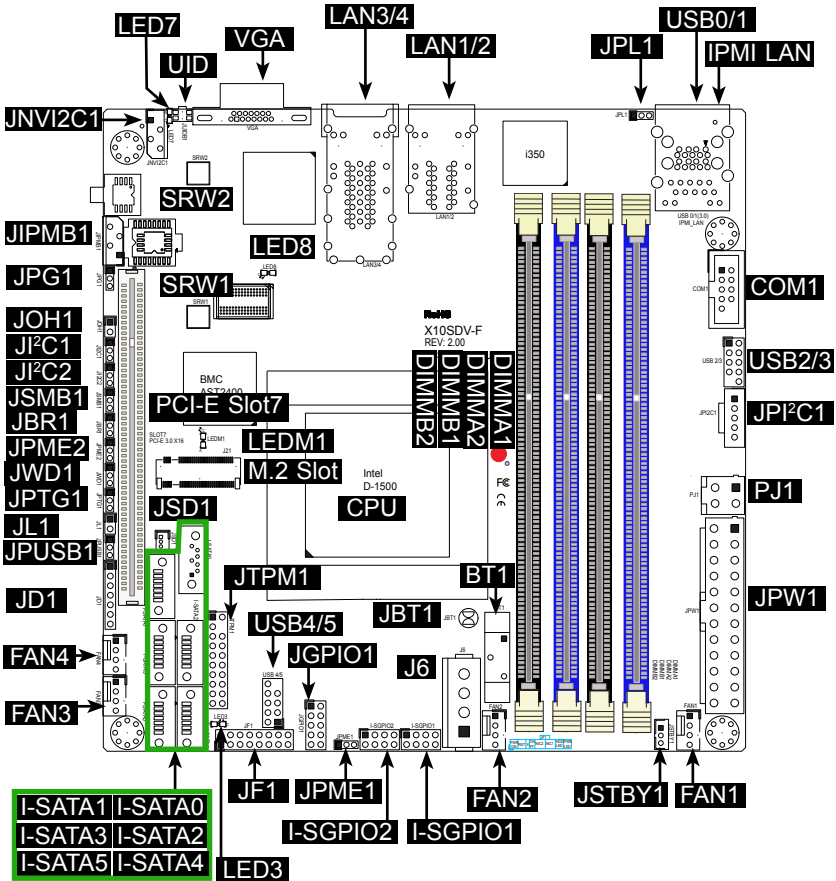

Note: FAN4 and JPI2CI are available on PCB 2.00 only.

X10SDV Mini-ITX Series Motherboard Model Variation Table

X10SDV Mini-ITX Series Motherboard PCB 2.00 Model Variation Table					
Model	X10SDV-6C-TLN4F	X10SDV-6C--TLN4F	X10SDV-12C-TLN4F	X10SDV-16C+TLN4F	X10SDV-16C-TLN4F
Processor Name	D-1528	D-1528	D-1557	D-1587	D-1587
# of Cores	6	6	12	16	16
# of Threads	12	12	24	32	32
Cache	9 MB	9 MB	18 MB	24 MB	24 MB
Processor Base Frequency	1.9 GHz	1.9 GHz	1.5 GHz	1.7 GHz	1.7 GHz
Max Turbo Frequency	2.5 GHz	2.5 GHz	2.1 GHz	2.3 GHz	2.3 GHz
Intel Turbo Boost Technology	Yes	Yes	Yes	Yes	Yes
SoC TDP	35 W	35 W	45 W	65 W	65 W
Dual 1GbE LAN	Yes	Yes	Yes	Yes	Yes
Dual 10GbE LAN	Yes	Yes	Yes	Yes	Yes
CPU Heatsink with FAN	No	Yes	No	Yes	No

X10SDV Mini-ITX Series Motherboard PCB 2.00 Model Variation Table (cont.)						
Model	X10SDV-TLN4F	X10SDV-8C-TLN4F	X10SDV-8C--LN2F	X10SDV-F	X10SDV-4C-TLN2F	X10SDV-4C-TLN4F
Processor Name	D-1541	D-1541	D-1541	D-1541	D-1521	D-1518
# of Cores	8	8	8	8	4	4
# of Threads	16	16	16	16	8	8
Cache	12 MB	12 MB	12 MB	12 MB	6 MB	6 MB
Processor Base Frequency	2.1 GHz	2.1 GHz	2.1 GHz	2.1 GHz	2.4 GHz	2.2 GHz
Max Turbo Frequency	2.7 GHz	2.7 GHz	2.7 GHz	2.7 GHz	2.7 GHz	N/A
Intel Turbo Boost Technology	Yes	Yes	Yes	Yes	Yes	No
SoC TDP	45 W	45 W	45 W	45 W	45 W	35 W
Dual 1GbE LAN	Yes	Yes	Yes	Yes	No	Yes
Dual 10GbE LAN	Yes	Yes	No	No	Yes	Yes
CPU Heatsink with FAN	Yes	No	Yes	No	No	No

X10SDV Mini-ITX Series Motherboard PCB 1.0x Model Variation Table					
Model	X10SDV-TLN4F	X10SDV-8C-TLN4F	X10SDV-8C--LN2F	X10SDV-F	X10SDV-4C-TLN2F
Processor Name	D-1540	D-1540	D-1540	D-1540	D-1520
# of Cores	8	8	8	8	4
# of Threads	16	16	16	16	8
Cache	12 MB	12 MB	12 MB	12 MB	6 MB
Processor Base Frequency	2.0 GHz	2.0 GHz	2.0 GHz	2.0 GHz	2.2 GHz
Max Turbo Frequency	2.6 GHz	2.6 GHz	2.6 GHz	2.6 GHz	2.6 GHz
Intel Turbo Boost Technology	Yes	Yes	Yes	Yes	Yes
SoC TDP	45 W	45 W	45 W	45 W	45 W
Dual 1GbE LAN	Yes	Yes	Yes	Yes	No
Dual 10GbE LAN	Yes	Yes	No	No	Yes
CPU Heatsink with FAN	Yes	No	Yes	No	No

Jumpers		
Jumper	Description	Default
JBR1	BIOS Recovery	Pins 1-2 (Normal)
JBT1	CMOS Clear	Open: Normal, Short: Clear CMOS
JI ² C1/JI ² C2	SMB to PCI-Exp. Slots	Pins 2-3 (Disabled)
JPG1	VGA Enable	Pins 1-2 (Enabled)
JPL1	LAN1/LAN2 Enable	Pins 1-2 (Enabled) (Not available on TLN2F)
JPME1	ME Recovery	Pins 1-2 (Normal)
JPME2	Manufacturing Mode	Pins 1-2 (Normal)
JPTG1	10Gb Ethernet Enable	Pins 1-2 (Enabled)
JPUSB1	USB Wakeup	Pins 1-2 (Enabled) (For USB0/1 Only)
JWD1	Watch Dog Enable	Pins 1-2 (Reset)

Headers/Connectors	
Connector	Description
BT1	Onboard Battery
COM1	COM1 Header
FAN1 ~ FAN4	CPU/System Cooling Fans (FAN4 is on PCB 2.00 only)
IPMI LAN	Dedicated IPMI LAN Port
I-SATA0 ~ I-SATA5	Intel [®] Serial ATA Ports (I-SATA0 supports SuperDOM)
I-SGPIO1, I-SGPIO2	Serial Link General Purpose I/O Headers
JGPIO1	General Purpose I/O Expander Header
J6	4-pin Power Connector for HDD use (To provide power from the motherboard to onboard HDD devices)
J21	M.2 Socket (Shared with I-SATA0 when a SATA device is installed in M.2)
JD1	Speaker (Pins 1-3: Power LED, Pins 4-7: Speaker)
JF1	Front Panel Control Header
JIPMB1	4-pin External SMBus I ² C Header (for an IPMI Card)
JL1	Chassis Intrusion Header
JNVI ² C1	NVMe I ² C Header
JOH1	Overheat LED Header
JPI ² C1	Power Supply SMBus I ² C Header (On PCB 2.00 only)
JPW1	24-pin ATX Main Power Connector
JSD1	SATA DOM (Device On Module) Power Connector

JSMB1	SMBus Header
JSTBY1	Standby Power Header
JTPM1	Trusted Platform Module (TPM)/Port 80 Connector
JUIDB1	Unit Identifier (UID) Button
LAN1 ~ LAN2	Gigabit Ethernet (RJ45) Ports (Not available on TLN2F)
LAN3 ~ LAN4	10G Ethernet (RJ45) Ports (TLN4F and TLN2F only)
PJ1	4-pin 12V DC Power Connector (To provide alternative power for special enclosure when the 24-pin ATX power is not in use.)
SLOT7	PCI-E 3.0 X16 Slot
SRW1, SRW2	M.2 Holding Screws
USB 0/1	Back panel USB 3.0 Ports
USB2/3, USB4/5	Front Access USB 2.0 Ports
VGA	Back panel VGA Port

LED Indicators

LED	Description	Color/State	Status
LEDM1	BMC Heartbeat LED	Green: Blinking	BMC: Normal
LED3	Power LED	Green: On	System Power On
LED7	UID Switch LED	Blue: On	Unit Identified
LED8	Overheat/PWR Fail/Fan Fail LED	Red: Solid on Blinking	Solid On: Overheat, Blinking: PWR Fail or Fan Fail

Motherboard Features

CPU	Intel [®] Xeon D-1500 SoC Processor Family 4C: D-1518/D-1521, 4 Core, 8 Threads, 6MB Cache 6C: D-1528, 6 Core, 12 Threads, 9MB Cache 8C: D-1541, 8 Core, 16 Threads, 12MB Cache 12C: D-1557, 12 Core, 24 Threads, 18MB Cache 16C: D-1587, 16 Core, 32 Threads, 24MB Cache				
Memory	Supports up to 128GB DDR4 ECC RDIMM or 64GB DDR4 ECC/Non-ECC UDIMM with speeds of 1600MHz, 1800MHz, 2133MHz, and up to 2400MHz in selected SKUs in four (4) slots				
	<table border="1"> <tr> <th colspan="2" data-bbox="364 501 913 529">DIMM sizes</th> </tr> <tr> <td data-bbox="364 536 518 632">DIMMs</td> <td data-bbox="522 536 913 632">4GB, 8GB, 16GB and 32GB (32GB for RDIMM only, Dual Rank Data width x4)</td> </tr> </table>		DIMM sizes		DIMMs
DIMM sizes					
DIMMs	4GB, 8GB, 16GB and 32GB (32GB for RDIMM only, Dual Rank Data width x4)				
Expansion Slot	One (1) M.2 PCIe 3.0 x4 Slot, M Key for 2242/2280 SSD, SATA 3.0 support (Mux with ISATA-0)				
Network Connections	Network Controllers				
	Intel [®] I350-AM2 GbE Controller (-F, -LN2F, -TLN4F only) Intel [®] D-1500 SoC 10GbE Controller (-TLN2F, -TLN4F only)				
	LAN Ports				
	Four (4) RJ-45 rear IO panel connectors with Link and Activity LEDs (-TLN4F) Two (2) RJ-45 rear IO panel connectors with Link and Activity LEDs (-F, -LN2F, -TLN2F)				
	<table border="1"> <tr> <th colspan="2" data-bbox="364 1015 913 1043">IPMI LAN Port 2.0</th> </tr> <tr> <td colspan="2" data-bbox="364 1050 913 1078">Supported by Aspeed AST2400 BMC</td> </tr> </table>		IPMI LAN Port 2.0		Supported by Aspeed AST2400 BMC
IPMI LAN Port 2.0					
Supported by Aspeed AST2400 BMC					
IO Devices	SATA Connections				
	SATA 3.0 (6GB/s)	Six (6) SATA 3.0 ports			
	RAID	RAID 0, 1, 5, 10			
	USB Devices				
	Four (4) USB 2.0 via two headers Two (2) USB 3.0 via rear IO panel connector				
Serial (COM) Port					
One (1) header					

	IPMI 2.0 IPMI 2.0 supported by Aspeed AST2400 BMC (Base-board Management Controller)
	VGA (Graphics Display) One (1) VGA Port on the rear IO panel supported by the Aspeed AST2400 VGA Controller
BIOS	128 Mb AMI BIOS® SPI EEPROM BIOS Plug and Play, ACPI 5.0, SMBIOS 2.8, BIOS Rescue Hot-Key, RTC Wakeup, Dual-Boot Block
Power Configuration	ACPI/ACPM Power Management (S0, S4 and S5 only) Wake-On LAN Power Button Override Power-on mode for AC power recovery
PC Health Monitoring	Onboard Voltage Monitoring +1.8V, +3.3V, +5V, +/-12V, +3.3V Stby, +5V Stby, VBAT, HT, Memory, PCH Temp, System Temp, Memory Temp CPU 1+1-phase switching voltage regulator CPU/System overheat LED and control CPU Thermal Trip support Power Supply Monitoring Thermal Monitor Support Fan Control Low noise fan speed control Fan status monitoring via IPMI connections Dual Cooling Zone (PCB 2.00 only) BMC Health Monitoring BMC Fan control and thermal alert by sensors monitoring, including CPU, memory and motherboard ambient temperatures
System Management	PECI (Platform Environment Configuration Interface) 3.0 System resource alert via SuperDoctor® 5 SuperDoctor® 5, Watch Dog Timer, NMI, Node Manager Chassis Intrusion header and detection
Other	RoHs (Full Compliance, Lead Free) Operating Temperature 0 ^o -60 ^o C
Dimensions	Miini-ITX form factor (6.7" x 6.7")

X10SDV Mini-ITX Series Block Diagram

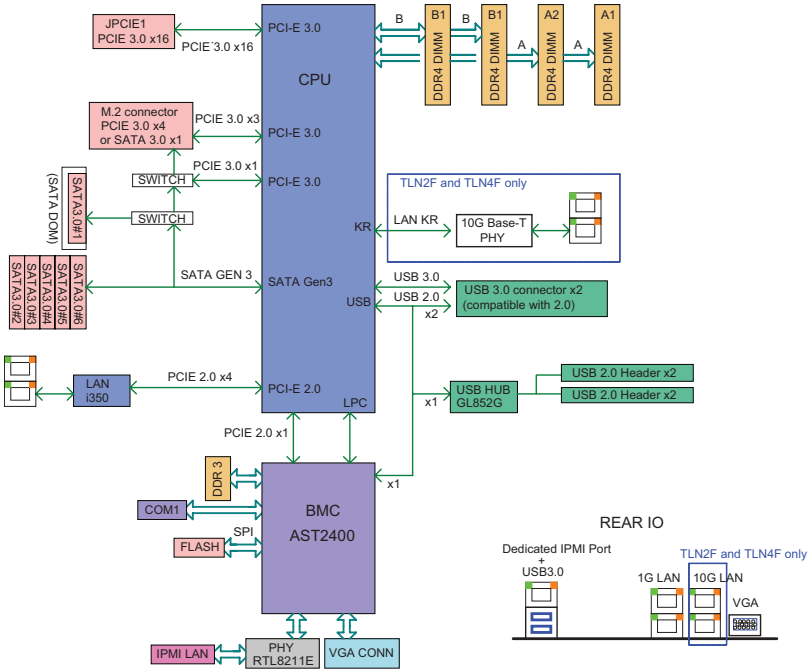

System Block Diagram



Note: This is a general block diagram and may not exactly represent the features on your motherboard. See the Motherboard Features pages for the actual specifications of each motherboard.

1-2 Processor Overview

The Intel® Xeon® D-1500 product family is the third generation, low-powered 64-bit SoC (System-on-a-Chip) processor that is optimized to deliver high performance, energy efficiency and enhance the total cost of ownership solutions. The low-power consumption of the processor makes it suitable for dense servers that can effectively take on hyperscale workloads, intelligent edge network or ultra-dense embedded devices.

Based on the 14nm microarchitecture, the Xeon D-1500 SoC processor family offers between 4~16 processor cores on 35~65W of power.

Intel Xeon D-1500 Processor Features

- Low Power Consumption
- Server-Class Reliability, Availability and Serviceability (RAS)
- Intel Hyper-Threading and AVX2
- Intel Turbo Boost (Not available for D-1518)
- Intel Virtualization Technology (VT-x, VT-d)
- 10 Gigabit Ethernet Controller Built In (-TLN2F & -TLN4F only)
- Memory 2133MHz DDR4 ECC up to 128GB RDIMM or 64GB ECC/Non-ECC UDIMM (D-1541 up to 2400MHz)
- AES-NI, TSX-NI, OS Guard, TXT Security Features
- SoC Built-in USB 3.0, USB 2.0 and 6 SATA 3.0 with SGPIO support
- Intel Rapid Storage Technology Enterprise (RSTe)

1-3 Special Features

Recovery from AC Power Loss

Basic IO System (BIOS) provides a setting for you to determine how the system will respond when AC power is lost and then restored to the system. You can choose for the system to remain powered off, (in which case you must press the power switch to turn it back on), or for it to automatically return to a power-on state. See the Advanced BIOS Setup section to change this setting. The default setting is **Last State**.

1-4 PC Health Monitoring

This section describes the PC health monitoring features of the board. All have an onboard System Hardware Monitoring chip that supports PC health monitoring. An onboard voltage monitor will scan these onboard voltages continuously: +1.8V, +3.3V, +5V, +/-12V, +3.3V Stby, +5V Stby, VBAT, HT, Memory, PCH Temperature, System Temperature, and Memory Temperature. Once a voltage becomes unstable, a warning is given, or an error message is sent to the screen.

Environmental Temperature Control

Some X10SDV models come with an active heatsink built in while others come with a passive heatsink for rackmount systems that are chassis-fan optimized (refer to the model variation tables on page 1-9). Please follow the instructions given in your system design guide or your system user manual to provide adequate airflow to your system. The onboard BaseBoard Management Controller (BMC) monitors CPU, memory and motherboard environment temperatures for fan control and PC health management.



Note: To avoid possible system overheating, please be sure to provide adequate airflow to your system.

System Resource Alert

This feature is available when the system is used with SuperDoctor[®] 5 in the Windows and Linux operating systems. SuperDoctor is used to notify the user of certain system events. For example, you can also configure SuperDoctor to provide you with warnings when the system temperature, CPU temperatures, voltages and fan speeds go beyond predefined thresholds.

1-5 ACPI Features

ACPI stands for Advanced Configuration and Power Interface. The ACPI specification defines a flexible and abstract hardware interface that provides a standard way to integrate power management features throughout a PC system, including its hardware, operating system and application software. This enables the system to automatically turn on and off peripherals such as CD-ROMs, network cards, hard disk drives and printers.

In addition to enabling operating system-directed power management, ACPI also provides a generic system event mechanism for Plug and Play, and an operating system-independent interface for configuration control. ACPI leverages the Plug and Play BIOS data structures, while providing a processor architecture-independent implementation that is compatible with Windows® 7, Windows 8, and Windows 2008 operating systems. The X10SDV Series motherboards support S0, S4 and S5 only.

1-6 Power Supply

As with all computer products, a stable power source is necessary for proper and reliable operation. It is even more important for processors that have high CPU clock rates.

It is strongly recommended that you use a high quality power supply that meets ATX power supply Specification 2.02 or above. It must also be SSI compliant. (For more information, please refer to the web site at <http://www.ssiforum.org/>). Additionally, in areas where noisy power transmission is present, you may choose to install a line filter to shield the computer from noise. It is recommended that you also install a power surge protector to help avoid problems caused by power surges.

 **Note 1:** The X10SDV series motherboard alternatively supports 4-pin 12V DC input power at PJ1 for embedded applications. The 12V DC input is limited to 18A by design. It provides up to 216W power input to the motherboard. Please keep onboard power use within the power limits specified above. Over-current DC power use may cause damage to the motherboard!

 **Note 2:** Do not use the 4-pin DC power at PJ1 when the 24-pin ATX Power at JPW1 is connected to the power supply. Do not plug in both PJ1 and JPW1 at the same time.

Notes

Chapter 2

Installation

2-1 Standardized Warning Statements

The following statements are industry-standard warnings, provided to warn the user of situations which have the potential for bodily injury. Should you have questions or experience difficulty, contact Supermicro's Technical Support department for assistance. Only certified technicians should attempt to install or configure components. Read this section in its entirety before installing or configuring components in the Supermicro chassis.

Battery Handling



Warning!

There is a danger of explosion if the battery is replaced incorrectly. Replace the battery only with the same or equivalent type recommended by the manufacturer. Dispose of used batteries according to the manufacturer's instructions

電池の取り扱い

電池交換が正しく行われなかった場合、破裂の危険性があります。交換する電池はメーカーが推奨する型、または同等のものを使用下さい。使用済電池は製造元の指示に従って処分して下さい。

警告

電池更換不當會有爆炸危險。請只使用同類電池或制造商推薦的功能相當的電池更換原有電池。請按製造商的說明處理廢舊電池。

警告

電池更換不當會有爆炸危險。請使用製造商建議之相同或功能相當的電池更換原有電池。請按照製造商的說明指示處理廢棄舊電池。

Warnung

Bei Einsetzen einer falschen Batterie besteht Explosionsgefahr. Ersetzen Sie die Batterie nur durch den gleichen oder vom Hersteller empfohlenen Batterietyp. Entsorgen Sie die benutzten Batterien nach den Anweisungen des Herstellers.

Attention

Danger d'explosion si la pile n'est pas remplacée correctement. Ne la remplacer que par une pile de type semblable ou équivalent, recommandée par le fabricant. Jeter les piles usagées conformément aux instructions du fabricant.

¡Advertencia!

Existe peligro de explosión si la batería se reemplaza de manera incorrecta. Reemplazar la batería exclusivamente con el mismo tipo o el equivalente recomendado por el fabricante. Desechar las baterías gastadas según las instrucciones del fabricante.

אזהרה!

קיימת סכנת פיצוץ של הסוללה במידה והוחלפה בדרך לא תקינה. יש להחליף את הסוללה בסוג התואם מחברת יצרן מומלצת.

סילוק הסוללות המשומשות יש לבצע לפי הוראות היצרן.

هناك خطر من انفجار في حالة استبدال البطارية بطريقة غير صحيحة فعليك استبدال البطارية فقط بنفس النوع أو ما يعادلها كما أوصت به الشركة المصنعة تخلص من البطاريات المستعملة وفقا لتعليمات الشركة الصانعة

경고!

배터리가 올바르게 교체되지 않으면 폭발의 위험이 있습니다. 기존 배터리와 동일하거나 제조사에서 권장하는 동등한 종류의 배터리로만 교체해야 합니다. 제조사의 안내에 따라 사용된 배터리를 처리하여 주십시오.

Waarschuwing

Er is ontploffingsgevaar indien de batterij verkeerd vervangen wordt. Vervang de batterij slechts met hetzelfde of een equivalent type die door de fabrikant aanbevolen wordt. Gebruikte batterijen dienen overeenkomstig fabrieksvoorschriften afgevoerd te worden.

Product Disposal



Warning!

Ultimate disposal of this product should be handled according to all national laws and regulations.

製品の廃棄

この製品を廃棄処分する場合、国の関係する全ての法律・条例に従い処理する必要があります。

警告

本产品的废弃处理应根据所有国家的法律和规章进行。

警告

本產品的廢棄處理應根據所有國家的法律和規章進行。

Warnung

Die Entsorgung dieses Produkts sollte gemäß allen Bestimmungen und Gesetzen des Landes erfolgen.

¡Advertencia!

Al deshacerse por completo de este producto debe seguir todas las leyes y reglamentos nacionales.

Attention

La mise au rebut ou le recyclage de ce produit sont généralement soumis à des lois et/ou directives de respect de l'environnement. Renseignez-vous auprès de l'organisme compétent.

סילוק המוצר

אזהרה!

סילוק סופי של מוצר זה חייב להיות בהתאם להנחיות וחוקי המדינה.

عند التخلص النهائي من هذا المنتج ينبغي التعامل معه وفقا لجميع القوانين واللوائح الوطنية

경고!

이 제품은 해당 국가의 관련 법규 및 규정에 따라 폐기되어야 합니다.

Waarschuwing

De uiteindelijke verwijdering van dit product dient te geschieden in overeenstemming met alle nationale wetten en reglementen.

2-2 Static-Sensitive Devices

Electrostatic-Discharge (ESD) can damage electronic components. To avoid damaging your system board, it is important to handle it very carefully. The following measures are generally sufficient to protect your equipment from ESD.

Precautions

- Use a grounded wrist strap designed to prevent static discharge.
- Touch a grounded metal object before removing the board from the antistatic bag.
- Handle the board by its edges only; do not touch its components, peripheral chips, memory modules or gold contacts.
- When handling chips or modules, avoid touching their pins.
- Put the motherboard and peripherals back into their antistatic bags when not in use.
- For grounding purposes, make sure your computer chassis provides excellent conductivity between the power supply, the case, the mounting fasteners and the motherboard.
- Use only the correct type of onboard CMOS battery. Do not install the onboard battery upside down to avoid possible explosion.

Unpacking

The motherboard is shipped in antistatic packaging to avoid static damage. When unpacking the board, make sure that the person handling it is static protected.

2-3 Motherboard Installation

All motherboards have standard mounting holes to fit different types of chassis. Make sure that the locations of all the mounting holes for both motherboard and chassis match. Although a chassis may have both plastic and metal mounting fasteners, metal ones are highly recommended because they ground the motherboard to the chassis. Make sure that the metal standoffs click in or are screwed in tightly. Then use a screwdriver to secure the motherboard onto the motherboard tray.

Tools Needed

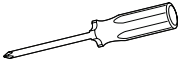

Philips Screwdriver
(1)



Philips Screws (4)



Standoffs (4)
Only if Needed

Location of Mounting Holes

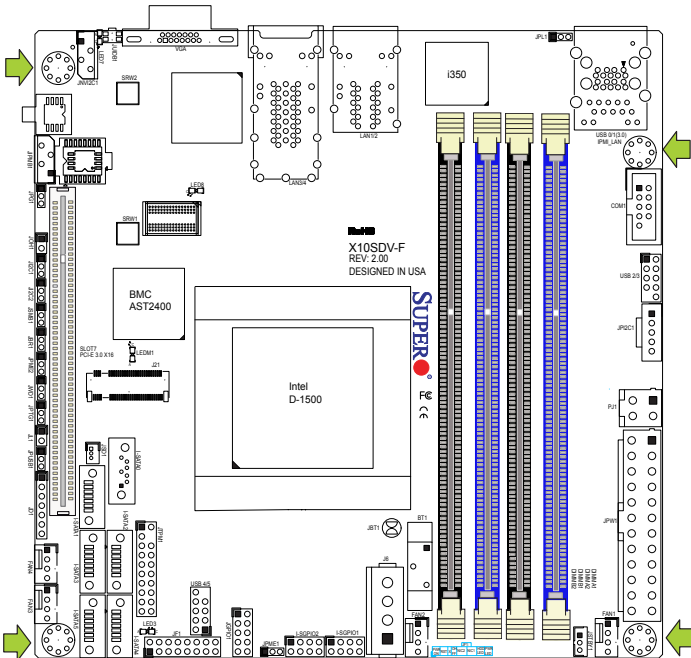

Caution: 1) To avoid damaging the motherboard and its components, please do not use a force greater than 8 lb/inch on each mounting screw during motherboard installation. 2) Some components are very close to the mounting holes. Please take precautionary measures to avoid damaging these components when installing the motherboard to the chassis.

Installing the Motherboard

1. Install the I/O shield into the back of the chassis.

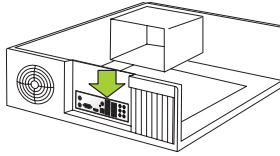

2. Locate the mounting holes on the motherboard. (See the previous page.)
3. Locate the matching mounting holes on the chassis. Align the mounting holes on the motherboard against the mounting holes on the chassis.
4. Install standoffs in the chassis as needed.

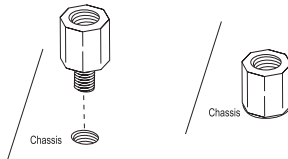

5. Install the motherboard into the chassis carefully to avoid damaging other motherboard components.
6. Using the Phillips screwdriver, insert a Phillips head #6 screw into a mounting hole on the motherboard and its matching mounting hole on the chassis.

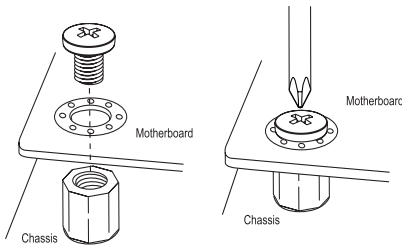

7. Repeat Step 5 to insert #6 screws into all mounting holes.
8. Make sure that the motherboard is securely placed in the chassis.

 **Note:** Images displayed are for illustration only. Your chassis or components might look different from those shown in this manual.

2-4 Memory Support

The X10SDV Mini-ITX series motherboard supports up to 128GB of DDR4 ECC RDIMM or 64GB of DDR4 ECC/Non-ECC UDIMM with speeds up to 2133MHz (D-1541 up to 2400MHz) in four memory slots. Populating these DIMM slots with memory modules of the same type and size will result in interleaved memory, which will improve memory performance.



Note: Check the Supermicro website for recommended memory modules.

CAUTION

Exercise extreme care when installing or removing DIMM modules to prevent any possible damage.

Memory Population Guidelines

Please follow the table below when populating the motherboard.

Recommended Population (Balanced)				
DIMMA1 Slot	DIMMB1 Slot	DIMMA2 Slot	DIMMB2 Slot	Total System Memory
4GB	4GB			8GB
4GB	4GB	4GB	4GB	16GB
8GB	8GB			16GB
8GB	8GB	8GB	8GB	32GB
16GB	16GB	16GB	16GB	64GB
32GB	32GB			64GB
32GB	32GB	32GB	32GB	128GB

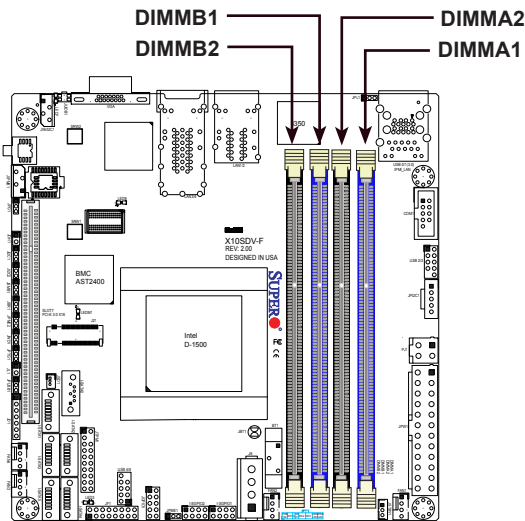

Memory Installation Guidelines

When installing memory modules, the DIMM slots should be populated in the following order: DIMMA1, DIMMB1, then DIMMA2, DIMMB2.

- Always use DDR4 DIMM modules of the same size, type and speed. Mixing memory modules of different types and speeds is not allowed.
- The motherboard will support one DIMM module installed. However, for best memory performance, install DIMM modules in pairs.

Installing DIMM Memory Modules

1. Align the key on the bottom of the DIMM module against the key on the memory slot. Take note of the notches on the side of the DIMM module, and of the locking clips on the socket to avoid causing damage.

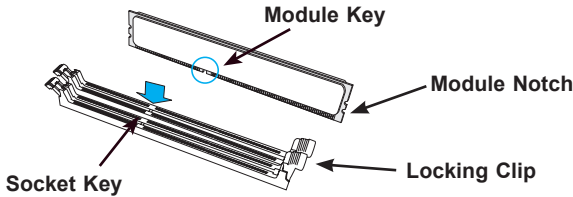

2. Install the DIMM module straight down into the socket until it is securely seated in the socket. The side clips will automatically lock the module into place.

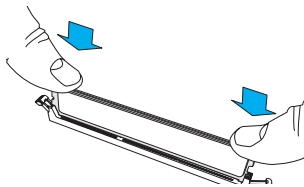

Removing DIMM Memory Modules

Reverse the steps above to remove the DIMM modules from the motherboard.

2-5 Connectors/I/O Ports

The I/O ports are color coded in conformance with the industry standards. See the figure below for the colors and locations of the various I/O ports.

Back panel I/O Panel

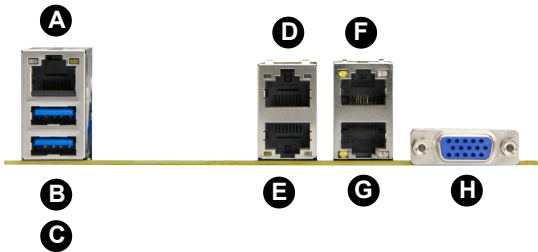
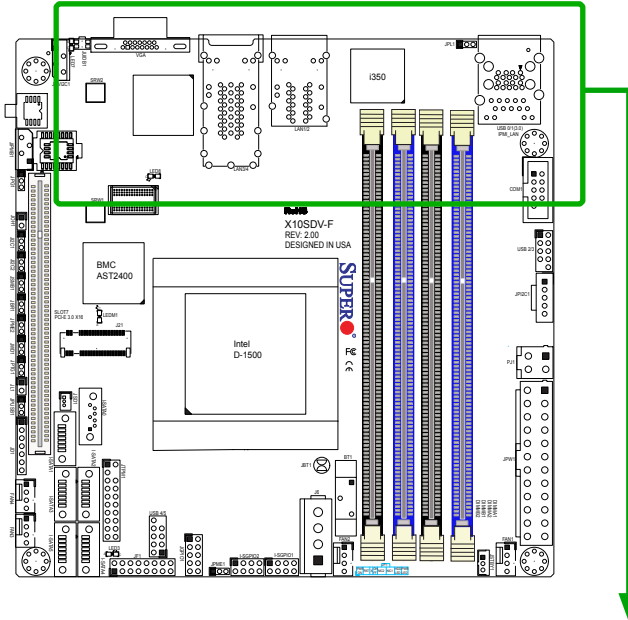

Back Panel I/O			
A	IPMI LAN	E	LAN Port 1 (-F, -LN2F, -TLN4F)
B	USB Port 1	F	LAN Port 4 (-TLN2F and -TLN4F)
C	USB Port 0	G	LAN Port 3 (-TLN2F and -TLN4F)
D	LAN Port 2 (-F, -LN2F, -TLN4F)	H	VGA Port

Serial Port

COM1 port is located near DIMM slot A1 to provide a front accessible serial connection. See the table on the right for pin definitions.

COM Port 1 Pin Definitions			
Pin #	Definition	Pin #	Definition
1	DCD	6	DSR
2	RXD	7	RTS
3	TXD	8	CTS
4	DTR	9	RI
5	Ground	10	N/A

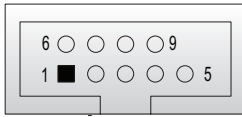

COM1 Pin Layout

A. COM1

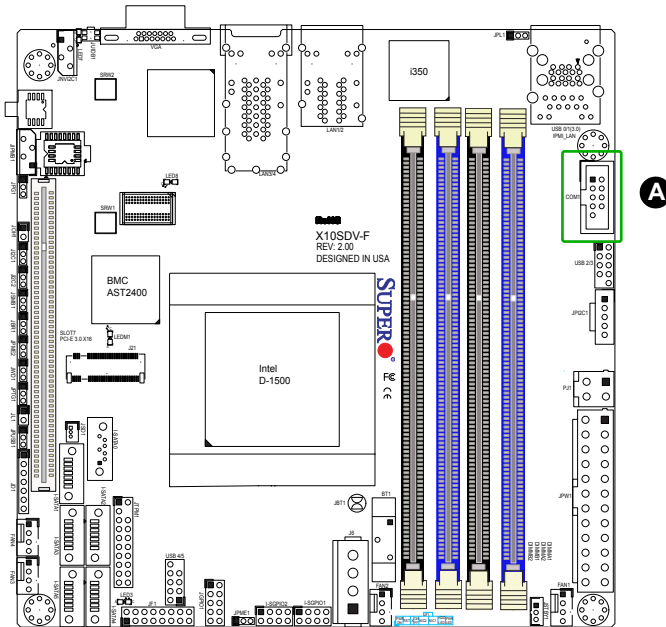

Ethernet Ports

Two Gigabit Ethernet ports (LAN1~LAN2), two 10G Ethernet ports (LAN3~LAN4) (availability varies by model), and an IPMI LAN port are located on the I/O back panel to provide network connections. These ports accept RJ45 type cables.

 **Note:** Please refer to the LED Indicator Section for LAN LED information.

LAN Ports Pin Definitions			
Pin #	Definition	Pin #	Definition
1	VCC	10	SGND
2	TD0+	11	Act LED
3	TD0-	12	P3V3SB
4	TD1+	13	Link 100 LED (Green, +3V3SB)
5	TD1-	14	Link 1000 LED (Yellow, +3V3SB)
6	TD2+	15	Ground
7	TD2-	16	Ground
8	TD3+	17	Ground
9	TD3-	18	Ground

- A. LAN1
- B. LAN2
- C. LAN3
- D. LAN4
- E. IPMI LAN

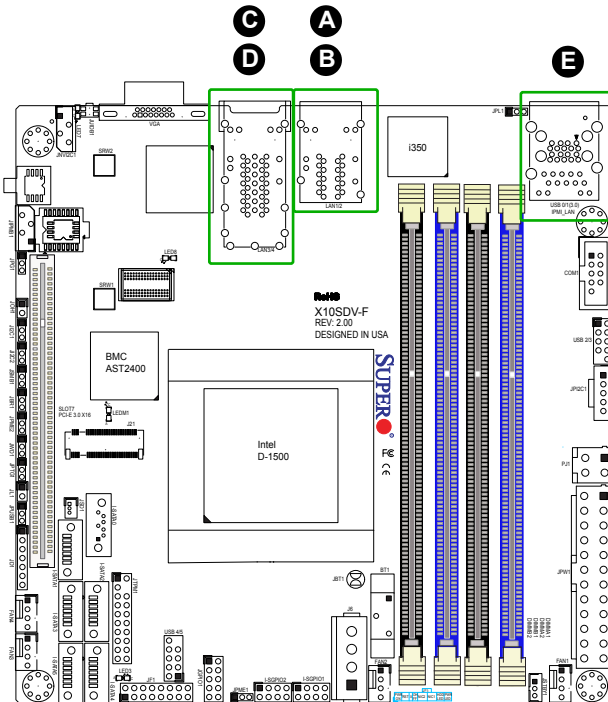

Universal Serial Bus (USB)

Two USB 3.0 ports (USB0/1) are located on the I/O back panel. Two USB 2.0 headers (USB2/3, 4/5) are on the motherboard to provide front panel access. USB cables are not included. See the tables below for pin definitions.

Back Panel USB Pin Definitions			
Pin #	Definition	Pin #	Definition
1	+5V	6	+5V
2	USB_PN1	7	USB_PN0
3	USB_PP1	8	USB_PP0
4	Ground	8	Ground

Internal USB Port 2.0 Pin Definitions			
Pin #	Definition	Pin #	Definition
1	+5V	2	+5V
3	USB_PN2	4	USB_PN3
5	USB_PP2	6	USB_PP3
7	Ground	8	Ground
9	Key	10	NC

A. USB 3.0 Ports 0/1

B. USB 2.0 Ports 2/3

C. USB 2.0 Ports 4/5

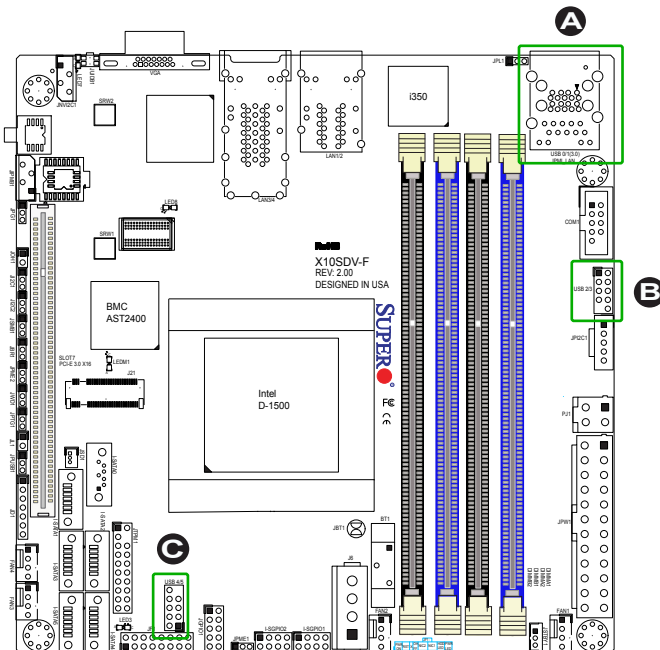

Unit Identifier Switch

A Unit Identifier (UID) Switch and two LED indicators are located on the motherboard. The UID Switch is located next to the VGA port on the back plane. The Rear UID LED (LED7) is located next to the UID Switch. The Front Panel UID LED is located at Pin 7 of the Front Control Panel at JF1. Connect a cable to Pin 7 on JF1 for Front Panel UID LED indication. When you press the UID switch, both Rear UID LED and Front Panel UID LED Indicators will be turned on. Press the UID switch again to turn off both LED Indicators. These UID Indicators provide easy identification of a system unit that may be in need of service.

UID Switch	
Pin#	Definition
1	Ground
2	Ground
3	Button In
4	Button In

UID LED Status	
Color/State	Status
Blue: On	Unit Identified

Note: UID can also be triggered via IPMI on the motherboard. For more information on IPMI, please refer to the IPMI User's Guide posted on our website at <http://www.supermicro.com>.

VGA

A VGA port is located next to the LAN ports on the I/O back panel. Use this port to connect to a compatible VGA display.

- A. UID Switch
- B. Rear UID LED
- C. Front UID LED
- D. VGA

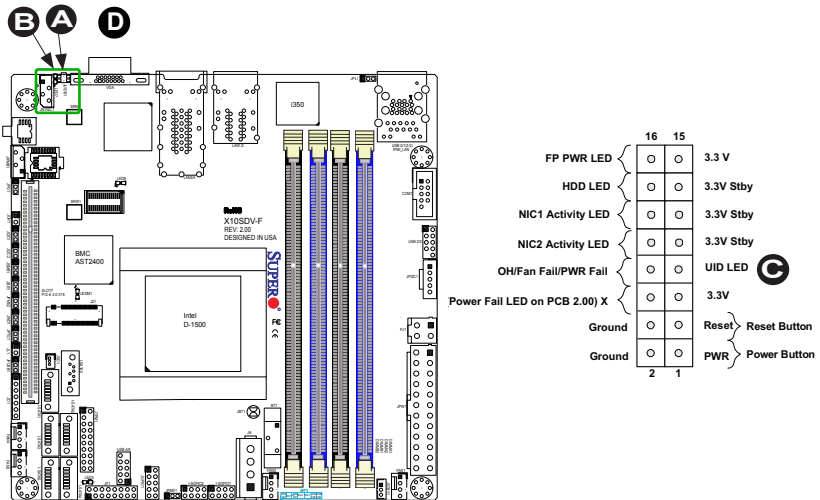

Front Control Panel

JF1 contains header pins for various buttons and indicators that are normally located on a control panel at the front of the chassis. These connectors are designed specifically for use with Supermicro chassis. See the figure below for the descriptions of the front control panel buttons and LED indicators. Refer to the following section for descriptions and pin definitions.

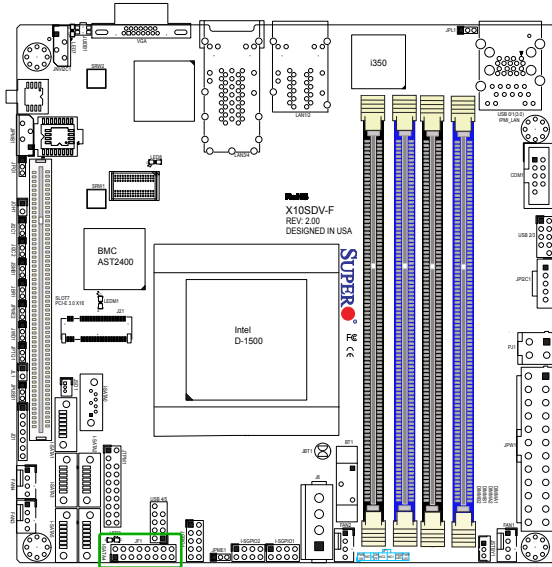

JF1 Header Pins

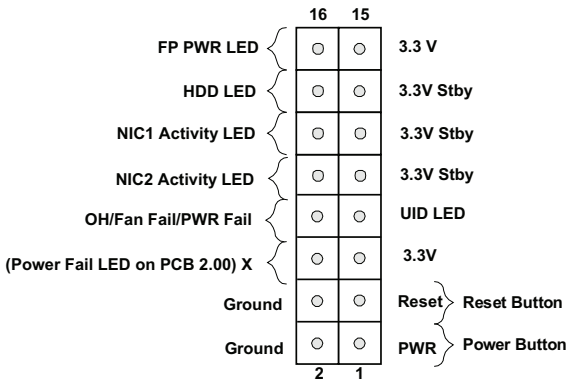

Front Control Panel Pin Definitions

Power LED

The Power LED connection is located on pins 15 and 16 of JF1. Refer to the table on the right for pin definitions.

Power LED Pin Definitions (JF1)	
Pin#	Definition
15	3.3V
16	PWR LED

Overheat (OH)/Fan Fail/PWR Fail/ UID LED

Connect an LED cable to pins 7 and 8 of JF1 (Front Control Panel) to use the Overheat/Fan Fail/Power Fail and UID LED connections. The blue LED on pin 7 works as the front panel UID LED indicator. The red LED on pin 8 provides warnings of overheating, fan failure or power failure. The red LED takes precedence over the blue LED by default. Refer to the table on the right for pin definitions.

OH/Fan Fail/PWR Fail/ Blue_UID_LED Pin Definitions (JF1)	
Pin#	Definition
7	Blue_UID_LED
8	OH/Fan Fail/PWR Fail

Power LED Pin Definitions (JF1)	
State	Definition
Off	Normal
On	Overheat
Blinking	Fan/PWR Fail

A. PWR LED

B. Overheat/Fan Fail/PWR Fail

C. UID LED

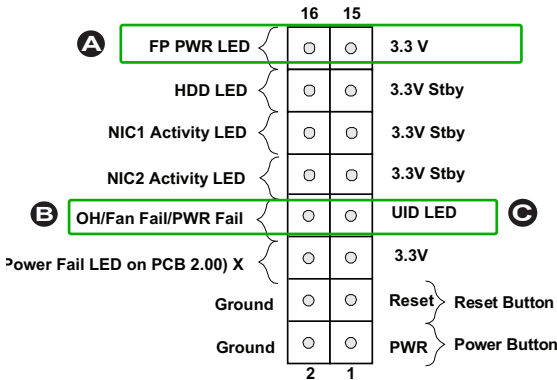

HDD LED

The HDD LED connection is located on pins 13 and 14 of JF1. Attach a cable here to indicate the status of HDD-related activities, including SATA activities. See the table on the right for pin definitions.

HDD LED Pin Definitions (JF1)	
Pin#	Definition
13	3.3V Standby
14	HD LED

NIC1/NIC2 (LAN1/LAN2)

The NIC (Network Interface Controller) LED connection for LAN port 2 is located on pins 9 and 10 of JF1, and the LED connection for LAN Port 1 is on Pins 11 and 12. Attach an LED cable to the respective pins. Refer to the table on the right for pin definitions.

LAN1/LAN2 LED Pin Definitions (JF1)	
Pin#	Definition
9-11	3.3V Standby
10-12	NIC Activity LED

- A. HDD LED
- B. NIC1 Activity LED
- C. NIC2 Activity LED

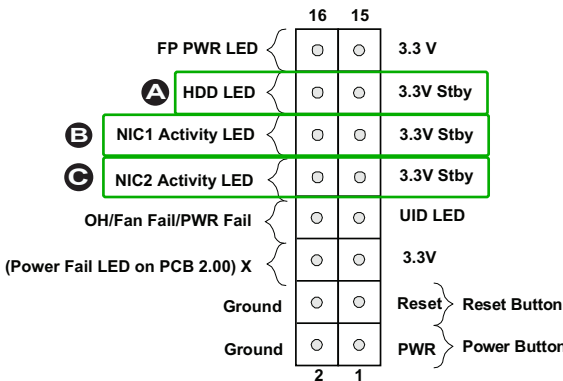

Reset Button

The Reset Button connection is located on pins 3 and 4 of JF1. Attach it to a hardware reset switch on the computer case to reset the system. Refer to the table on the right for pin definitions.

Reset Button Pin Definitions (JF1)	
Pin#	Definition
3	Reset
4	Ground

Power Button

The Power Button connection is located on pins 1 and 2 of JF1. Momentarily contacting both pins will power on/off the system. This button can be configured as 4 Seconds Override or Instant Off (with a setting in the BIOS setting, see Chapter 4). Refer to the table on the right for pin definitions.

Power Button Pin Definitions (JF1)	
Pin#	Definition
1	Signal
2	Ground

A. Reset Button

B. PWR Button

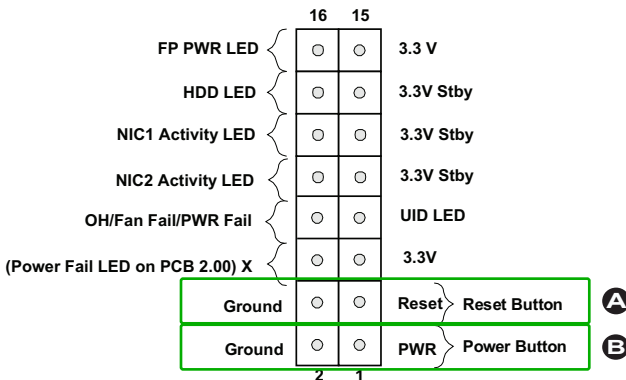

Power Fail LED
(Available on PCB 2.00 only)

The Power Fail LED connection is located on pins 5 and 6 of JF1. Refer to the table on the right for pin definitions

Power Fail LED Pin Definitions (JF1)	
Pin#	Definition
5	3.3V
6	PWR Supply Fail (Floating on PCB 1.0x)

A. Power Supply Fail
 (PCB 2.00 only)

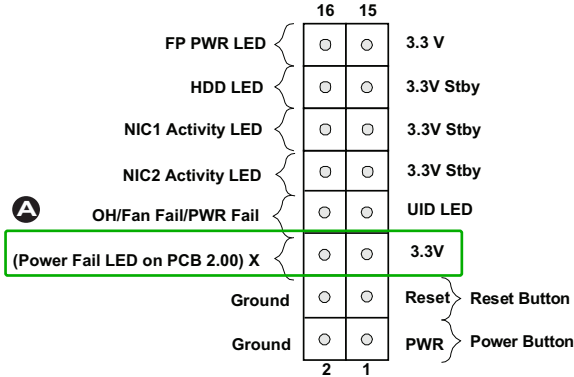

2-6 Connecting Cables

This section provides brief descriptions and pin-out definitions for onboard headers and connectors. Be sure to use the correct cable for each header or connector.

ATX PWR, DC PWR and HDD PWR Connectors (JPW1, PJ1, J6)

The 24-pin ATX power connector at JPW1 is used to provide power to the motherboard. PJ1 is the 12V DC power connector that provides alternative power for special enclosure when the 24-pin ATX power is not in use. The 4-pin ATX power is not in use. The 4-pin HDD power connector J6 provides power to onboard HDD devices.

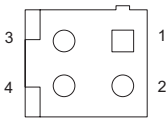

12V DC Power Pin Definitions (PJ1)	
Pin#	Definition
1-2	GND
3-4	12V

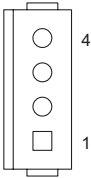

4-Pin HDD Power Pin Definitions (J6)	
Pin#	Definition
1	12V
2-3	GND
4	5V

ATX Power 24-pin Connector Pin Definitions (JPW1)			
Pin#	Definition	Pin #	Definition
13	+3.3V	1	+3.3V
14	NC	2	+3.3V
15	COM	3	COM
16	PS_ON	4	+5V
17	COM	5	COM
18	COM	6	+5V
19	COM	7	COM
20	NC	8	PWR_OK
21	+5V	9	5VSB
22	+5V	10	+12V
23	+5V	11	+12V
24	COM	12	+3.3V

A. 24-Pin ATX Power

B. 12V DC Power

C. 4-Pin HDD Power

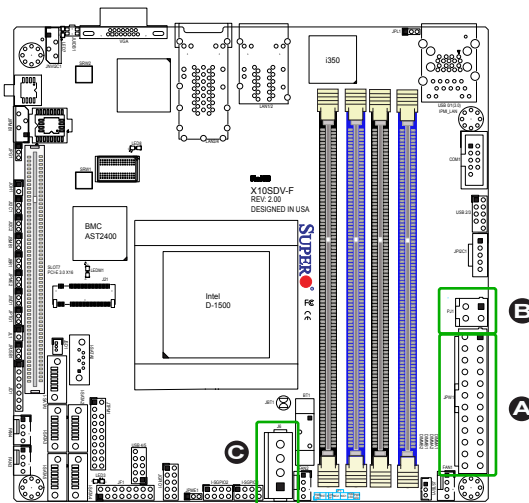

Fan Headers (FAN1 ~ FAN4)
(FAN4 is available on PCB 2.00 only)

This motherboard has up to four 4-pin fan headers. (Dual cooling zone is only available on PCB 2.00 with FAN4 serving as the second zone's FANA under IPMI). Although pins 1-3 of the fan headers are backward compatible with the traditional 3-pin fans, we recommend you use 4-pin fans to take advantage of the fan speed control via Pulse Width Modulation through the BMC. This allows the fan speeds to be automatically adjusted based on the motherboard temperature. Refer to the table on the right for pin definitions.

Fan Header Pin Definitions	
Pin#	Definition
1	Ground (Black)
2	12V (Red)
3	Tachometer
4	PWM_Control

Chassis Intrusion

A Chassis Intrusion header is located at JL1 on the motherboard. Attach the appropriate cable from the chassis to inform you of a chassis intrusion when the chassis is opened.

Chassis Intrusion Pin Definitions	
Pin#	Definition
1	Ground
2	Intrusion Input

- A. Fan 1
- B. Fan 2
- C. Fan 3
- D. Fan 4
- E. Chassis Intrusion

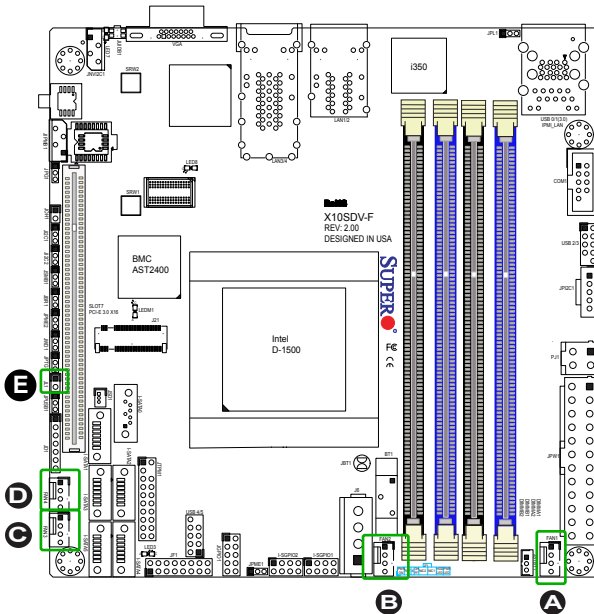

System Management Bus Header

A System Management Bus header for IPMI 2.0 is located at JIPMB1. Connect the appropriate cable here to use the IPMI I²C connection on your system.

SMBus Header Pin Definitions	
Pin#	Definition
1	Data
2	Ground
3	Clock
4	No Connection

DOM PWR Connector

The Disk-On-Module (DOM) power connector, located at JSD1, provides 5V power to a solid state DOM storage device connected to the SATA port. See the table on the right for pin definitions.

DOM PWR Pin Definitions	
Pin#	Definition
1	5V
2	Ground
3	Ground

A. SMBus Header

B. DOM Power

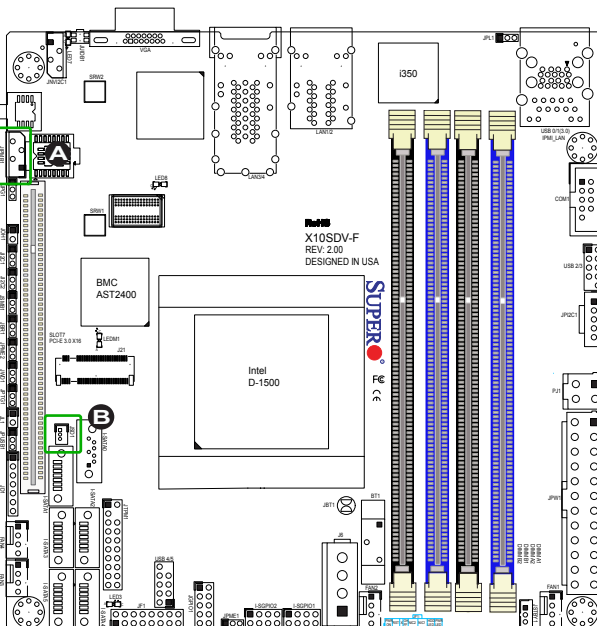

TPM Header/Port 80 Header

A Trusted Platform Module/Port 80 header, located at JTPM1, provides Trusted Platform (TPM) support and Port 80 connection. Use this header to enhance system performance and data security. See the table on the right for pin definitions.

TPM/Port 80 Header Pin Definitions			
Pin #	Definition	Pin #	Definition
1	LCLK	2	GND
3	LFRAME#	4	<(KEY)>
5	LRESET#	6	+5V
7	LAD 3	8	LAD 2
9	+3.3V	10	LAD1
11	LAD0	12	GND
13	NC	14	NC
15	+3V_DUAL	16	SERIRQ
17	GND	18	Ground
19	3.3V	20	NC

Overheat LED Header

The JOH1 header is used to connect an LED indicator to provide warnings of chassis overheating Refer to the tables on right for pin definitions.

Overheat LED Pin Definitions	
Pin #	Definition
1	3.3V
2	OH Active

OH Status (Red LED)	
State	Definition
Off	Normal
Solid	Overheat

A. TPM Header

B. Overheat LED Header

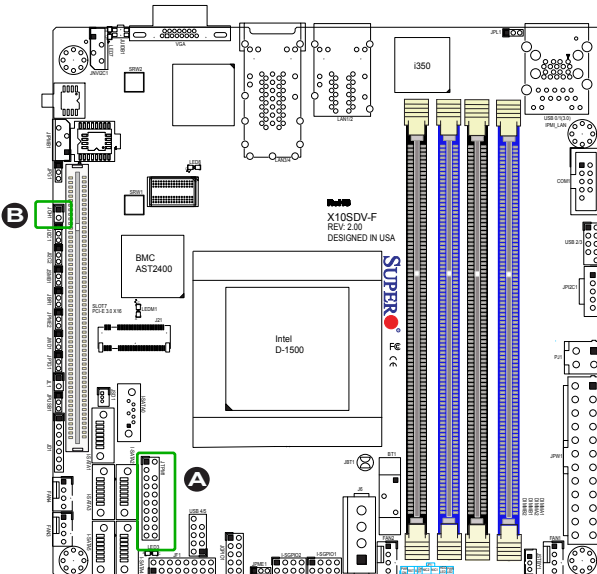

Speaker

On the JD1 header, pins 1-3 can be used for the power LED while pins 4-7 can be used for an external speaker. See the table on the right for pin definitions.

Speaker Connector Pin Definitions	
Pin#	Definition
1-3	Power LED
4-7	Speaker

Standby Power

The Standby Power header is located at JSTBY1 on the motherboard. See the table on the right for pin definitions.

Standby Power Pin Definitions	
Pin#	Definition
1	+5V Standby
2	Ground
3	No connection

A. JD1

B. Standby Power

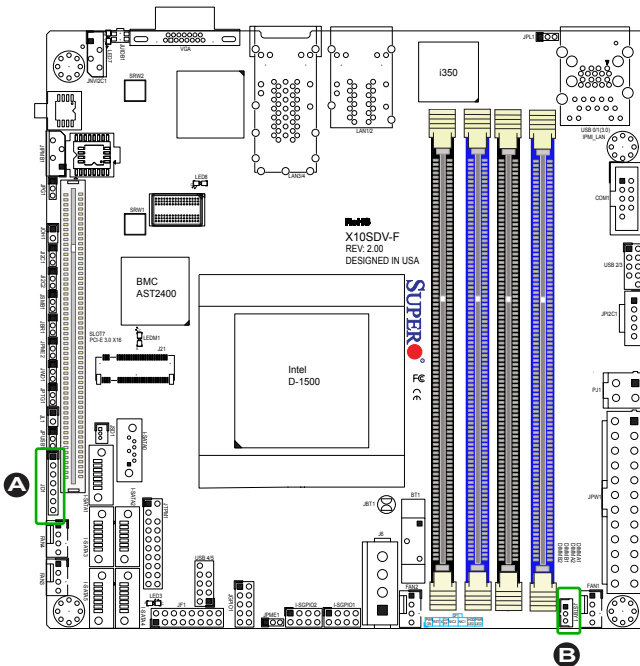

I-SGPIO1/I-SGPIO2

Two Serial Link General Purpose Input/Output (SGPIO) headers are used to communicate with the enclosure management chip in the system. See the table on the right for pin definitions. Refer to the board layout below for the locations of the headers.

Serial Link General Purpose Headers Pin Definitions			
Pin#	Definition	Pin	Definition
1	NC	2	NC
3	Ground	4	DATA Out
5	Load	6	Ground
7	Clock	10	NC

NVMe I2C Header

Connector JNV12C is a management header for the Supermicro AOC NVMe PCI-E peripheral cards. Please connect the I2C cable to this connector.

A. I-SGPIO1

B. I-SGPIO2

C. NVMe I²C Header

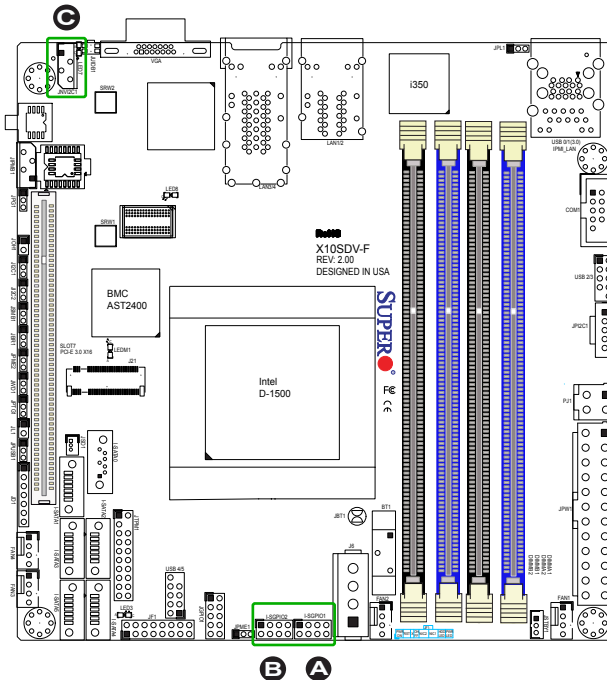

**Power SMBus (I²C) Connector
(available on PCB 2.00 only)**

Power System Management Bus (I²C) Connector (JPI²C1) monitors the power supply, fan and system temperatures. See the table on the right for pin definitions.

Power SMBus Pin Definitions	
Pin#	Definition
1	Clock
2	Data
3	Power Fail
4	Ground
5	+3.3V

System Management Bus Header

A PCH System Management Bus header for additional slave devices or sensors is located at JSMB1. See the table on the right for pin definitions.

SMBus Header Pin Definitions	
Pin#	Definition
1	Data
2	Ground
3	Clock

A. Power SMBus (I²C) Connector
B. SMBus Header

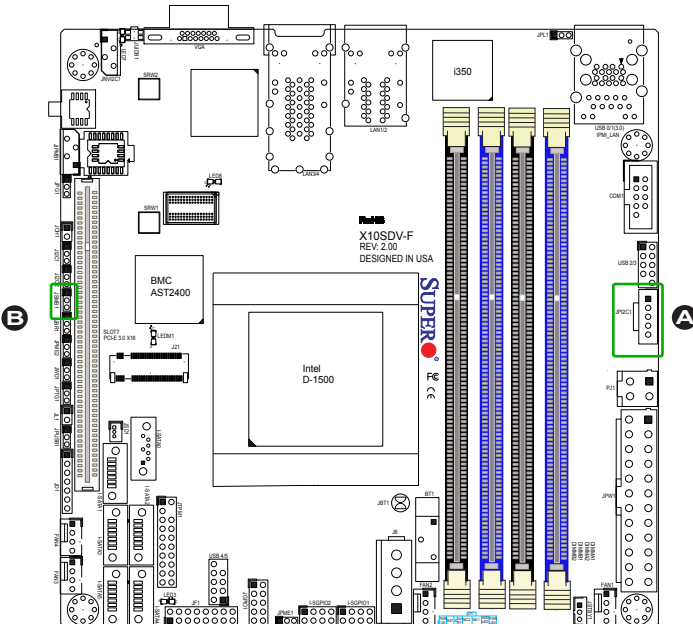

GPIO Header

The JGPIO1 header is located near the SATA connectors on the motherboard. The JGPIO header is a general purpose I/O on a pin header. See the table on the right for pin definitions. Refer to the board layout below for the locations of the headers.

GPIO Header Pin Definitions			
Pin#	Definition	Pin	Definition
1	P3V3	2	GND
3	GP0	4	GP1
5	GP2	6	GP3
7	GP5	8	GP5
9	GP6	10	GP7

GPIO Register Address Table To Control JGPIO Pin Header				
JGPIO1 PIN#	SoC GPIO#	USE Select	IO Select	Level
1	Power			
2	Ground			
3	17	IO 0x500 [17]	IO 0x504 [17]	IO 0x50C [17]
4	68	IO 0x540 [4]	IO 0x544 [4]	IO 0x548 [4]
5	01	IO 0x500 [1]	IO 0x504 [1]	IO 0x50C [1]
6	69	IO 0x540 [5]	IO 0x544 [5]	IO 0x548 [5]
7	06	IO 0x500 [6]	IO 0x504 [6]	IO 0x50C [6]
8	70	IO 0x540 [6]	IO 0x544 [6]	IO 0x548 [6]
9	07	IO 0x500 [7]	IO 0x504 [7]	IO 0x50C [7]
10	71	IO 0x540 [7]	IO 0x544 [7]	IO 0x548 [7]

Note: Please refer to the Intel Xeon Processor D-1500 Product Family Datasheet for more information.

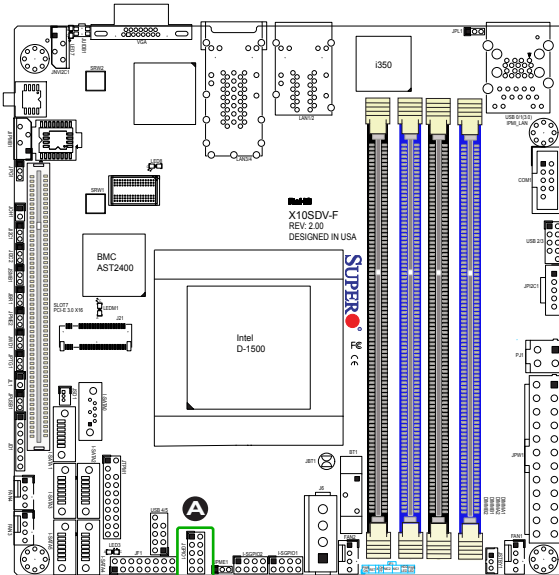

A. GPIO Header

2-7 Jumper Settings

Explanation of Jumpers

To modify the operation of the motherboard, jumpers can be used to choose between optional settings. Jumpers create shorts between two pins to change the function of the connector. Pin 1 is identified with a square solder pad on the printed circuit board.

Note: On two-pin jumpers, "Closed" means the jumper is on, and "Open" means the jumper is off the pins.

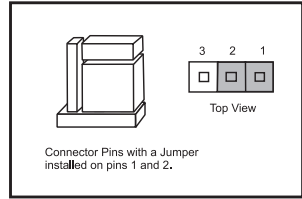
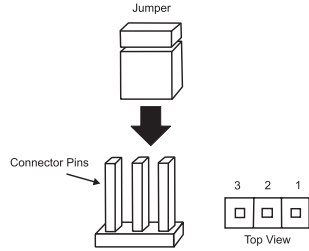

VGA Enable

Jumper JPG1 allows the user to enable the onboard VGA connector. The default setting is pins 1-2 to enable the connection. See the table on the right for jumper settings.

VGA Enable Jumper Settings	
Pin#	Definition
1-2	Enabled (Default)
2-3	Disabled

A. VGA Enable

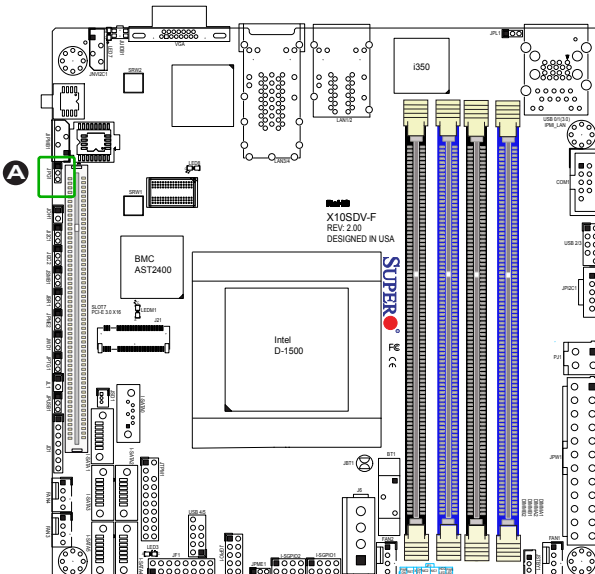

CMOS Clear

JBT1 is used to clear CMOS. Instead of pins, this "jumper" consists of contact pads to prevent accidental clearing of CMOS. To clear CMOS, use a metal object such as a small screwdriver to touch both pads at the same time to short the connection. Always remove the AC power cord from the system before clearing CMOS.



Note 1: For an ATX power supply, you must completely shut down the system, remove the AC power cord, and then short JBT1 to clear CMOS.

Note 2: Be sure to remove the onboard CMOS Battery before you short JBT1 to clear CMOS.

Note 3: Clearing CMOS will also clear all passwords.

PCI-E Slot SMB Enable (I²C1/I²C2)

Use jumpers I²C1/I²C2 to enable PCI SMB (System Management Bus) support to improve system management for the onboard PCI-E slot. See the table on the right for jumper settings.

PCI Slot SMB Enable Jumper Settings	
Pin#	Definition
1-2	Enabled
2-3	Disabled (Default)

A. Clear CMOS

B. JI²C1

C. JI²C2

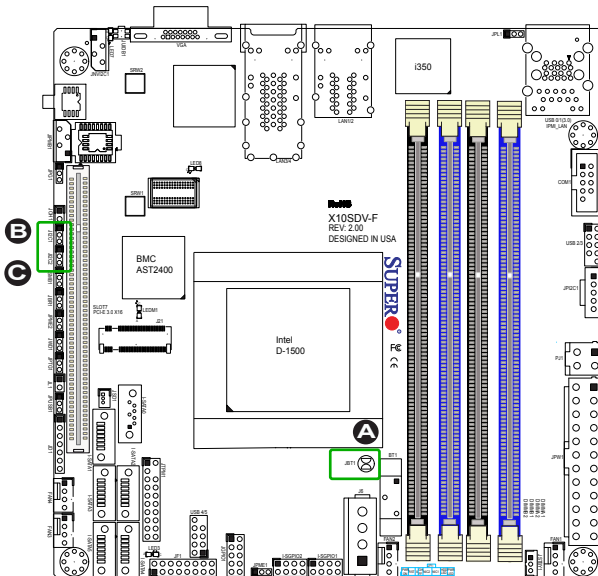

Watch Dog Timer Enable

Watch Dog (JWD1) is a system monitor that can reboot a system when a software application hangs. Close pins 1-2 to reset the system if an application hangs. Close pins 2-3 to generate a non-maskable interrupt signal for the application that hangs. See the table on the right for jumper settings. Watch Dog must also be enabled in the BIOS Setup. The default timer is around 5 minutes.

Watch Dog Jumper Settings	
Pin#	Definition
1-2	Reset (Default)
2-3	NMI
Open	Disabled

USB Wake-Up

Use the JPUSB1 jumper to enable the function of "System Waking-Up via USB devices" for USB0/1. This jumper allows you to "wake-up" the system by pressing a key on the USB keyboard or by clicking the USB mouse of your system. The JPUSB1 jumper is used together with the USB Wake-Up function in the BIOS. Enable both the jumper and the BIOS setting to enable this function. See the table on the right for jumper settings and connections.

USB Wake-up Jumper Settings	
Pin#	Definition
1-2	Enabled (Default)
2-3	Disabled

A. Watch Dog Enable

B. USB Wake-Up

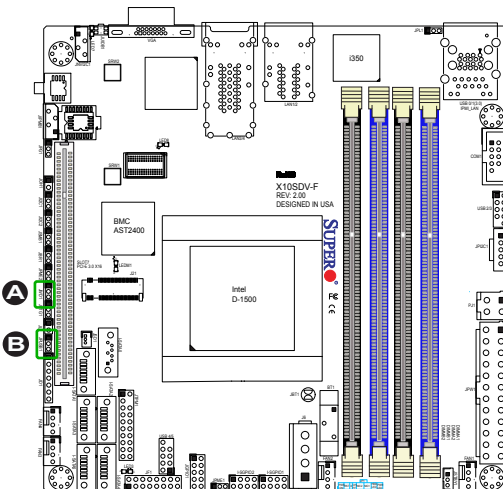

Management Engine (ME) Recovery

Use JPME1 to select ME Firmware Recovery mode, which will limit resource allocation for essential system operation only in order to maintain normal power operation and management. In the single operation mode, online upgrade will be available via Recovery mode. See the table on the right for jumper settings.

ME Recovery Jumper Settings	
Pin#	Definition
1-2	Normal (Default)
2-3	ME Recovery

ME Manufacturing Mode

Close JPME2 to bypass SPI flash security and force the system to use the Manufacturing Mode, which will allow the user to flash the system firmware from a host server to modify system settings. See the table on the right for jumper settings.

Manufacturing Mode Jumper Settings	
Pin#	Definition
1-2	Normal (Default)
2-3	Manufacturing Mode

A. ME Recovery

B. Manufacturing Mode

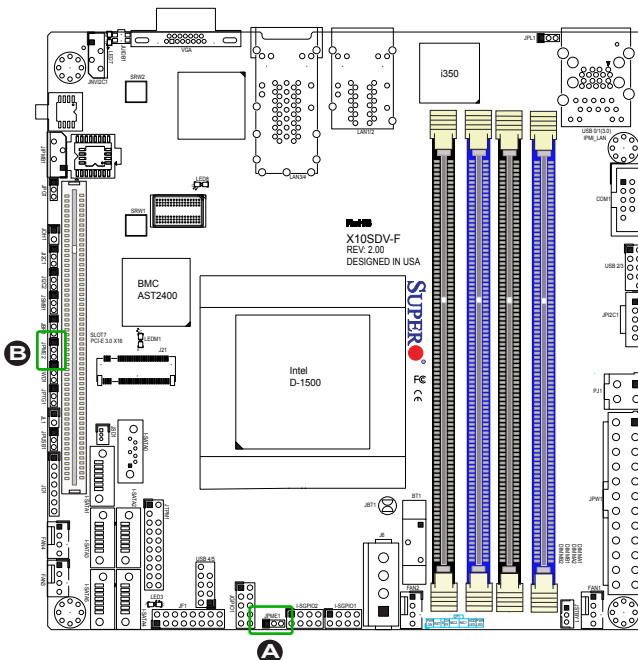

**Gigabit LAN Ports Enable/Disable
(on -F, -LN2F, -TLN4F models)**

JPL1 is used to enable or disable the Gigabit Ethernet ports (LAN1~LAN2) on the motherboard. See the table on the right for jumper settings.

GbE LAN Enable Jumper Settings	
Pin#	Definition
1-2	Enabled (Default)
2-3	Disabled

**10G LAN Ports Enable/Disable
(on -TLN2F and -TLN4F models)**

JPTG1 is used to enable or disable the 10 Gigabit Ethernet ports (LAN3 ~ LAN4) on the motherboard. See the table on the right for jumper settings.

10Gb Enable/Disable Jumper Settings	
Pin#	Definition
1-2	Enabled (Default)
2-3	Disabled

A. 1G LAN Port Enable/Disable

B. 10Gb LAN Port Enable/Disable

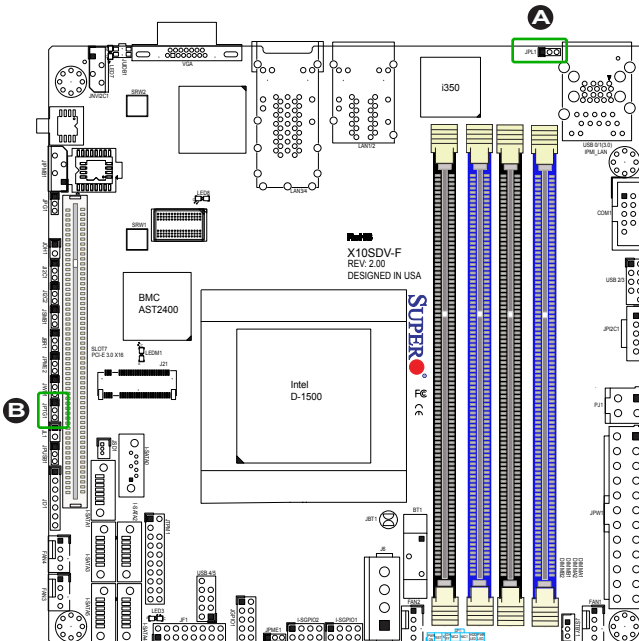

BIOS Recovery

Close pins 2 and 3 of jumper JBR1 for BIOS recovery. The default setting is on pins 1 and 2 for normal operation. See the table on the right for jumper settings.

BIOS Recovery Jumper Settings	
Pin#	Definition
1-2	Normal
2-3	BIOS Recovery

A. BIOS Recovery

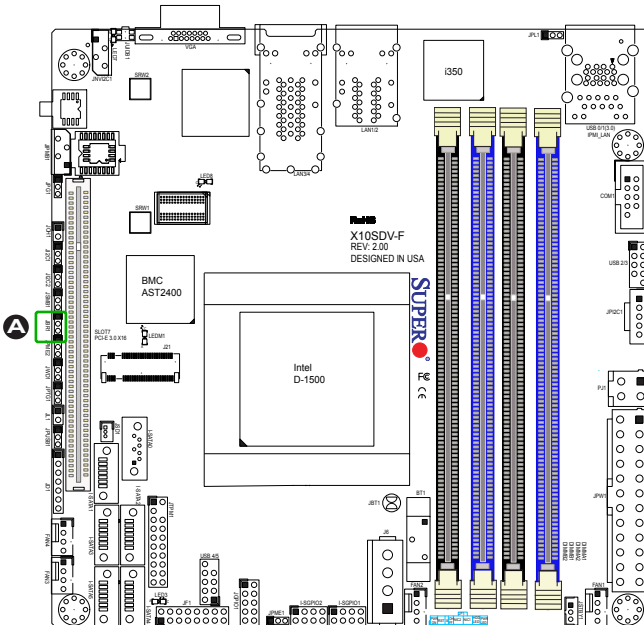

2-8 Onboard Indicators

LAN LEDs

Depending on the model, this motherboard offers two 1GbE and/or two 10GbE LAN ports (refer to model variation table on page 1-9). Each port has two LED indicators. The yellow LED indicates connection and activity. The Link LED may be green, amber or off to indicate the speed of the connection. See the tables on the right for more information.

Activity LED LED Settings		
Color	Status	Definition
Off	No Connections	
Yellow	Flashing	Active

Link Speed LED	
Color	Definition
Off	No Connection or 10 Mbps
Amber	1 Gbps
Green	100Mbps (10Gbps for 10GbE Port)

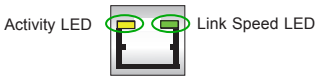

BMC Heartbeat LED

A BMC Heartbeat LED is located at LEDM1. See the table on the right for more information.

BMC Heartbeat LED Status	
Color/State	Definition
Green: Blinking	BMC: Normal

A. LAN LEDs

B. BMC Heartbeat LED

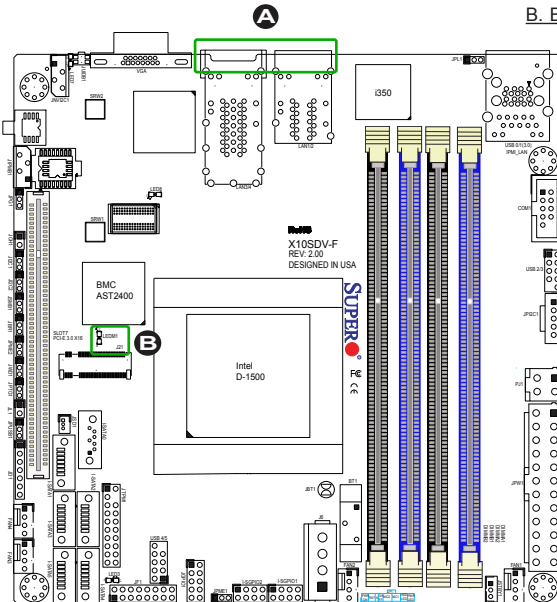

Onboard Power LED

An onboard Power LED is located at LED3 on the motherboard. When this LED is on, the system is on. Please turn off the system and unplug the power cord before removing or installing components. See the table on the right for more information.

Onboard PWR LED Indicator LED Settings	
Color	Definition
Off	System Off (PWR cable not connected)
Green	System On

Overheat/PWR Fail/Fan Fail LED

An onboard Overheat/PWR Fail/Fan Fail LED is located at LED8. See the table on the right for more information.

Overheat/PWR Fail/Fan Fail LED Settings	
Color	Definition
Solid	Overheat
Blinking	Power Fail or Fan Fail

A. PWR LED

B. OH/PWR Fail/Fan Fail LED

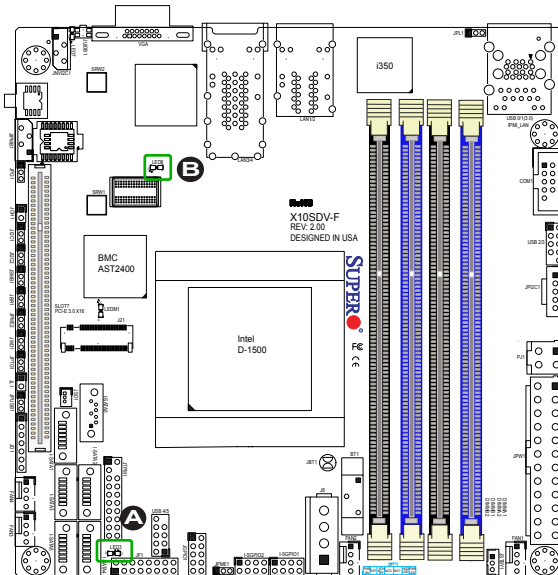

Unit Identification LED

A rear UID LED indicator (LED7) is located next to the Unit Identifier (UID) switch on the I/O back panel. The front panel UID LED is located at pin 7 of the Front Control Panel at JF1. Connect a cable to pin 7 on JF1 for front panel UID LED indication. When you press the UID switch, both rear UID LED and front panel UID LED Indicators will be turned on. Press the UID switch again to turn off both LED Indicators. These UID Indicators provide easy identification of a system unit that may be in need of service.

Note: UID can also be triggered via IPMI on the motherboard. For more information on IPMI, please refer to the IPMI User's Guide posted on our website at <http://www.supermicro.com>.

UID LED Status	
Color/State	Status
Blue: On	Unit Identified

A. UID LED

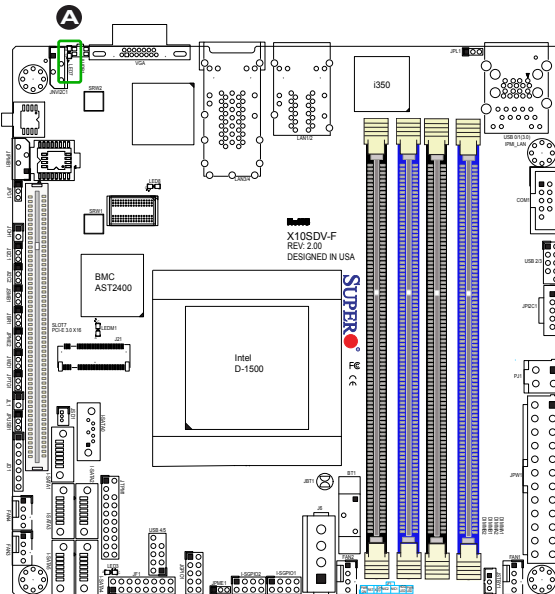

2-9 SATA Connections

SATA Ports (I-SATA0 ~ I-SATA5)

There are six SATA 3.0 ports on the motherboard. These ports provide serial-link signal connections with the option of Intel RSTe [RAID 0,1,5,10]. I-SATA0 also supports SuperDOM, Supermicro's proprietary SATA DOM with built-in power connection via pin 8.

M.2 Socket

M.2 is formerly known as Next Generation Form Factor (NGFF). The J21 connector is designed for internal mounting devices. The X10SDV series deploy an M key only dedicated for SSD devices with the ultimate performance capability in a PCI Express 3.0 X4 interface for native PCIe SSD support. The X10SDV M.2 is mux with the I-SATA0 port for legacy SATA SSD devices.

- A. I-SATA0
- B. I-SATA1
- C. I-SATA2
- D. I-SATA3
- E. I-SATA4
- F. I-SATA5
- G. M.2 Socket

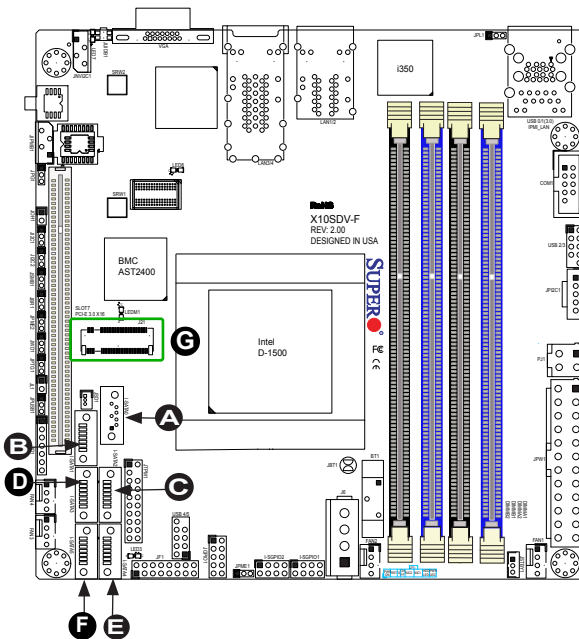

Chapter 3

Troubleshooting

3-1 Troubleshooting Procedures

Use the following procedures to troubleshoot your system. If you have followed all of the procedures below and still need assistance, refer to the 'Technical Support Procedures' and/or 'Returning Merchandise for Service' section(s) in this chapter. Always disconnect the AC power cord before adding, changing or installing any hardware components.

Before Power On

1. Make sure that the PWR LED is not on. (**Note:** If it is on, the onboard power is on. Be sure to unplug the power cable before installing or removing the components.)
2. Make sure that there are no short circuits between the motherboard and chassis.
3. Disconnect all ribbon/wire cables from the motherboard, including those for the keyboard and mouse. Also, be sure to remove all add-on cards.

No Power

1. Make sure that there are no short circuits between the motherboard and chassis.
2. Make sure that all jumpers are set to their default positions.
3. Check if the 115V/230V switch on the power supply is properly set.
4. Turn the power switch on and off to test the system.
5. The battery on your motherboard may be old. Check to make sure that it still supplies ~3VDC. If it does not, replace it with a new one.

No Video

1. If the power is on, but you have no video, you will need to remove all the add-on cards and cables first.

2. Install a PC buzzer via JD1 to determine if any beep codes exist. (Refer to Appendix A for details on beep codes.)
3. Remove all memory modules and turn on the system. (If the alarm is on, check the specifications of memory modules, reset the memory or try a different one.)

Memory Errors

1. Make sure that the DIMM modules are properly installed and fully seated in the slots.
2. You should be using either DDR4 ECC RDIMM or ECC/Non-ECC UDIMM (1.2V) 2133MHz memory recommended by Supermicro (D-1541 up to 2400MHz). Also, it is required that you use the memory modules of the same type and speed for all DIMMs in the system. Do not use memory modules of different sizes, different speeds, nor different types on the same motherboard.
3. Check for bad DIMM modules or slots by swapping modules between slots to see if you can locate the faulty ones.
4. Check the switch of 115V/230V power supply.

Losing the System's Setup Configuration

1. Please be sure to use a high quality power supply. A poor quality power supply may cause the system to lose CMOS setup information. Refer to Section 1-6 for details on recommended power supplies.
2. The battery on your motherboard may be old. Check to verify that it still supplies ~3VDC. If it does not, replace it with a new one.
3. If the above steps do not fix the Setup Configuration problem, contact your vendor for repairs.

3-2 Technical Support Procedures

Before contacting Technical Support, please make sure that you have followed all the steps listed below. Also, Note that as a motherboard manufacturer, Supermicro does not sell directly to end users, so it is best to first check with your distributor or reseller for troubleshooting services. They should know of any possible problem(s) with the specific system configuration that was sold to you.

1. Please go through the 'Troubleshooting Procedures' and 'Frequently Asked Question' (FAQ) sections in this chapter or see the FAQs on our website (<http://www.supermicro.com/support/faqs/>) before contacting Technical Support.
2. BIOS upgrades can be downloaded from our website at (<http://www.supermicro.com/support/bios/>).



Note: Not all BIOS can be flashed. It depends on the boot block code of the BIOS.

3. If you've followed the instructions above to troubleshoot your system, and still cannot resolve the problem, then contact Supermicro's technical support and provide them with the following information:
 - Motherboard model and PCB revision number
 - BIOS release date/version (this can be seen on the initial display when your system first boots up)
 - System configuration
 - An example of a Technical Support form is on our website at (<http://www.supermicro.com/RmaForm/>).
4. Distributors: For immediate assistance, please have your account number ready when placing a call to our technical support department. We can be reached by e-mail at support@supermicro.com, by phone at (408) 503-8000, option 2, or by fax at (408) 503-8019.

3-3 Frequently Asked Questions

Question: What type of memory does my motherboard support?

Answer: The X10SDV Mini-ITX motherboard supports up to 128GB of DDR4 ECC RDIMM or 64GB of DDR4 ECC/Non-ECC UDIMM memory of speeds up to 2133MHz (D-1541 up to 2400MHz). See Section 2-4 for details on installing memory.

Question: How do I update my BIOS?

Answer: We do NOT recommend that you upgrade your BIOS if you are not experiencing any problems with your system. Updated BIOS files are located on our website at <http://www.supermicro.com/support/bios/>. Please check our BIOS warning message and the information on how to update your BIOS on our web site. Select your motherboard model and download the BIOS ROM file to your computer. Also, check the current BIOS revision to make sure that it is newer than your BIOS before downloading. You may choose the zip file or the .exe file. If you choose the zipped BIOS file, please unzip the BIOS file onto a bootable device or a USB pen/thumb drive. To flash the BIOS, run the batch file named "ami.bat" with the new BIOS ROM file from your bootable device or USB pen/thumb drive. Use the following format:

```
F:\> FLASH.bat BIOS-ROM-filename.xxx <Enter>
```



Note: Always use the file named "FLASH.bat" to update the BIOS, and insert a space between "FLASH.bat" and the BIOS ROM image file name.

If you choose the .exe file, please run the .exe file under Windows to create the BIOS flash floppy disk. Insert the floppy disk into the system you wish to flash the BIOS. Then, boot the system to the floppy disk. The BIOS utility will automatically flash the BIOS without any prompts. Please note that this process may take a few minutes to complete. Do not be concerned if the screen is paused for a few minutes.

When the BIOS flashing screen is completed, the system will need to be powered off with the power source completely removed. Unplug the power source for about 10 seconds before reapplying and turning the system on to complete the BIOS upgrade.

Warning: Do not shut down or reset the system while updating the BIOS to prevent possible system boot failure!



Important: The SPI BIOS chip installed on this motherboard is not removable. To repair or replace a damaged BIOS chip, please send your motherboard to RMA at Supermicro for service.

3-4 Battery Removal and Installation

Battery Removal

To remove the onboard battery, follow the steps below:

1. Power off your system and unplug your power cable.
2. Locate the onboard battery as shown below.
3. Using a tool such as a pen or a small screwdriver, push the battery lock outwards to unlock it. Once unlocked, the battery will pop out from the holder.
4. Remove the battery.

Proper Battery Disposal

Warning: Please handle used batteries carefully. Do not damage the battery in any way; a damaged battery may release hazardous materials into the environment. Do not discard a used battery in the garbage or a public landfill. Please comply with the regulations set up by your local hazardous waste management agency to dispose of your used battery properly.

Battery Installation

1. To install an onboard battery, follow the steps 1 & 2 above and continue below:
2. Identify the battery's polarity. The positive (+) side should be facing up.
3. Insert the battery into the battery holder and push it down until you hear a click to ensure that the battery is securely locked.

Warning: When replacing a battery, be sure to only replace it with the same type.

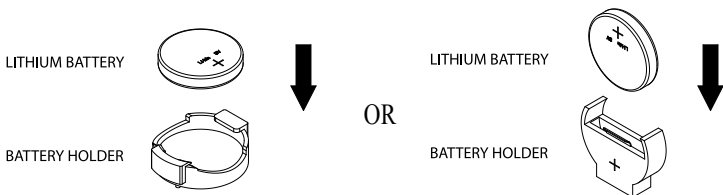

3-5 Returning Merchandise for Service

A receipt or copy of your invoice marked with the date of purchase is required before any warranty service will be rendered. You can obtain service by calling your vendor for a Returned Merchandise Authorization (RMA) number. For faster service, you may also obtain RMA authorizations online (<http://www.supermicro.com/RmaForm/>). When you return the motherboard to the manufacturer, the RMA number should be prominently displayed on the outside of the shipping carton, and mailed prepaid or hand-carried. Shipping and handling charges will be applied for all orders that must be mailed when service is complete.

This warranty only covers normal consumer use and does not cover damages incurred in shipping or from failure due to the alteration, misuse, abuse or improper maintenance of products.

During the warranty period, contact your distributor first for any product problems.

Chapter 4

BIOS

4-1 Introduction

This chapter describes the AMI BIOS setup utility for the X10SDV-TLN4F motherboard. The ROM BIOS is stored in a Flash EEPROM and can be easily updated. This chapter describes the basic navigation of the AMI BIOS setup utility setup screens.



Note: For AMI BIOS Recovery, please refer to the UEFI BIOS Recovery Instructions in Appendix C.

Starting BIOS Setup Utility

To enter the AMI BIOS setup utility screens, press the <Delete> key while the system is booting up.



Note: In most cases, the <Delete> key is used to invoke the AMI BIOS setup screen. There are a few cases when other keys are used, such as <F1>, <F2>, etc.

Each main BIOS menu option is described in this manual. The Main BIOS setup menu screen has two main frames. The left frame displays all the options that can be configured. Grayed-out options cannot be configured. Options in blue can be configured by the user. The right frame displays the key legend. Above the key legend is an area reserved for a text message. When an option is selected in the left frame, it is highlighted in white. Often a text message will accompany it. (**Note:** the AMI BIOS has default text messages built in. Supermicro retains the option to include, omit, or change any of these text messages.)

The AMI BIOS setup utility uses a key-based navigation system called "hot keys". Most of the AMI BIOS setup utility "hot keys" can be used at any time during the setup navigation process. These keys include <F1>, <F4>, <Enter>, <ESC>, arrow keys, etc.



Note: Options printed in **Bold** are default settings.

How To Change the Configuration Data

The configuration data that determines the system parameters may be changed by entering the AMI BIOS setup utility. This setup utility can be accessed by pressing at the appropriate time during system boot.

How to Start the Setup Utility

Normally, the only visible Power-On Self-Test (POST) routine is the memory test. As the memory is being tested, press the <Delete> key to enter the main menu of the AMI BIOS setup utility. From the main menu, you can access the other setup screens. An AMI BIOS identification string is displayed at the left bottom corner of the screen, below the copyright message.

Warning: Do not update the BIOS unless your system has a BIOS-related issue. Flashing the wrong BIOS can cause irreparable damage to the system. In no event shall Supermicro be liable for direct, indirect, special, incidental, or consequential damages arising from a BIOS update. If you have to update the BIOS, do not shut down or reset the system while the BIOS is updating. This is to avoid possible boot failure.

4-2 Main Setup

When you first enter the AMI BIOS setup utility, you will enter the Main setup screen. You can always return to the Main setup screen by selecting the Main tab on the top of the screen. The Main BIOS Setup screen is shown below.

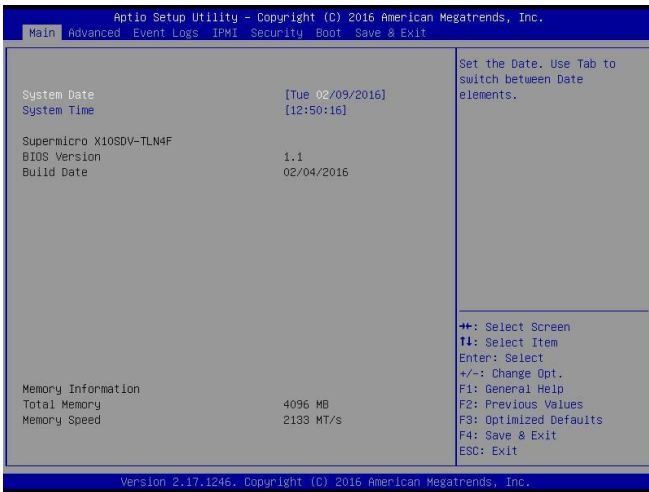

The following Main menu items will display:

System Date/System Time

Use this feature to change the system date and time. Highlight *System Date* or *System Time* using the arrow keys. Enter new values using the keyboard. Press the <Tab> key or the arrow keys to move between fields. The date must be entered in Day MM/DD/YY format. The time is entered in HH:MM:SS format.



Note: The time is in the 24-hour format. For example, 5:30 P.M. appears as 17:30:00.

The following BIOS items will also be displayed:

Supermicro X10SDV-TLN4F

Version

Build Date

Memory Information

Total Memory

This displays the total size of memory available in the system.

4-3 Advanced Setup Configurations

Use the arrow keys to select Boot Setup and press <Enter> to access the submenu items.

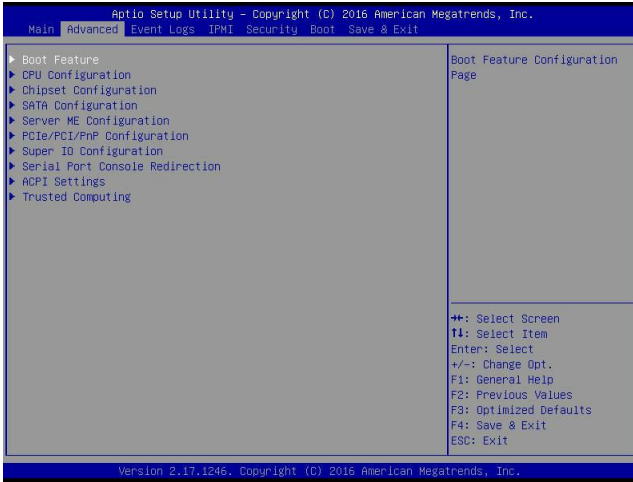

Warning: Take caution when changing the Advanced settings. An incorrect value, a very high DRAM frequency, or an incorrect DRAM timing setting may make the system unstable. When this occurs, revert to the default to the manufacture default settings.

► Boot Feature

Quiet Boot

Use this feature to select the screen display between the POST messages and the OEM logo upon bootup. Select Disabled to display the POST messages. Select Enabled to display the OEM logo instead of the normal POST messages. The options are **Enabled** and Disabled.

AddOn ROM Display Mode

Use this feature to set the display mode for the Option ROM. Select Keep Current to display the current AddOn ROM setting. Select Force BIOS to use the Option ROM display set by the system BIOS. The options are **Force BIOS** and Keep Current.

Startup NumLock State

Use this feature to set the Power-on state for the <Numlock> key. The options are Off and **On**.

Wait For 'F1' If Error

Use this feature to force the system to wait until the 'F1' key is pressed if an error occurs. The options are Disabled and **Enabled**.

INT19 (Interrupt 19) Trap Response

Interrupt 19 is the software interrupt that handles the boot disk function. When this item is set to Immediate, the ROM BIOS of the host adapters will "capture" Interrupt 19 at bootup immediately and allow the drives that are attached to these host adapters to function as bootable disks. If this item is set to Postponed, the ROM BIOS of the host adapters will not capture Interrupt 19 immediately and allow the drives attached to these adapters to function as bootable devices at bootup. The options are **Immediate** and Postponed.

Re-try Boot

If this item is enabled, the BIOS will automatically reboot the system from a specified boot device after its initial boot failure. The options are **Disabled**, Legacy Boot, and EFI Boot.

► Power Configuration**Watch Dog Function**

If enabled, the Watch Dog Timer will allow the system to reset or generate NMI based on jumper settings when it is expired for more than 5 minutes. The options are **Disabled** and Enabled.

Power Button Function

This feature controls how the system shuts down when the power button is pressed. Select 4_Seconds_Override for the user to power off the system after pressing and holding the power button for 4 seconds or longer. Select Instant Off to instantly power off the system as soon as the user presses the power button. The options are 4 Seconds Override and **Instant Off**.

Restore on AC Power Loss

Use this feature to set the power state after a power outage. Select Stay-Off for the system power to remain off after a power loss. Select Power-On for the system power to be turned on after a power loss. Select Last State to allow the system to resume its last power state before a power loss. The options are Power-On, Stay-Off, and **Last State**.

► CPU Configuration

The following CPU information will be displayed:

- Processor ID
- Processor Frequency
- Processor Max Ratio
- Processor Min Ratio
- Microcode Revision
- L1 Cache RAM
- L2 Cache RAM
- L3 Cache Ram
- CPU Version

Clock Spread Spectrum

If this feature is set to Enabled, the BIOS utility will monitor the level of Electro-magnetic Interference caused by the components and will attempt to reduce the interference whenever needed. The options are **Disabled** and Enabled.

Hyper-Threading (ALL)

Select Enable to use Intel Hyper-Threading Technology to enhance CPU performance. The options are Disable and **Enable**.

Cores Enabled

Set a numeric value to enable the number of cores. (Please refer to Intel's website for more information.) Enter **0** to enable all cores.

Monitor/Mwait

Select Enabled to enable the Monitor/MWait instructions. The Monitor instruction monitors a region of memory for writes, and MWait instructions instruct the CPU to stop until the monitored region begins to write. The options are Disable and **Enable**.

Execute Disable Bit (Available if supported by the OS & the CPU)

Select Enabled to enable the Execute-Disable Bit which will allow the processor to designate areas in the system memory where an application code can execute and where it cannot, thus preventing a worm or a virus from flooding illegal codes to overwhelm the processor or damage the system during an attack. The default is **Enable**. (Refer to the Intel® and Microsoft® websites for more information.)

PPIN Control

Select Unlock/Enable to use the Protected-Processor Inventory Number (PPIN) in the system. The options are **Unlock/Enable** and Unlock/Disable.

Hardware Prefetcher (Available when supported by the CPU)

If set to Enabled, the hardware prefetcher will prefetch streams of data and instructions from the main memory to the L2 cache to improve CPU performance. The options are **Enable** and Disable.

Adjacent Cache Prefetch (Available when supported by the CPU)

The CPU prefetches the cache line for 64 bytes if this feature is set to Disabled. The CPU prefetches both cache lines for 128 bytes as comprised if this feature is set to **Enable**.

DCU Streamer Prefetcher (Available when supported by the CPU)

Select Enabled to enable the DCU (Data Cache Unit) Streamer Prefetcher which will stream and prefetch data and send it to the Level 1 data cache to improve data processing and system performance. The options are **Enable** and Disable.

DCU IP Prefetcher (Available when supported by the CPU)

Select Enabled for DCU (Data Cache Unit) IP Prefetcher support, which will prefetch IP addresses to improve network connectivity and system performance. The options are **Enable** and Disable.

Direct Cache Access (DCA)

Select Enabled to use Intel's DCA (Direct Cache Access) Technology to improve data transfer efficiency. The options are Disable, Enable, and **Auto**.

Intel® Virtualization Technology (Available when supported by the CPU)

Select Enabled to support Intel® Virtualization Technology, which will allow one platform to run multiple operating systems and applications in independent partitions, creating multiple "virtual" systems in one physical computer. The options are **Enable** and Disable.



Note: If a change is made to this setting, you will need to reboot the system for the change to take effect. Refer to Intel's website for detailed information.

► Advanced Power Management Configuration

This section is used to configure the following CPU Power Management settings.

EIST (P-States)

EIST (Enhanced Intel SpeedStep Technology) allows the system to automatically adjust processor voltage and core frequency to reduce power consumption and heat dissipation. The options are Disable and **Enable**.

If the above is set to Enable, CPU P State will display:

► CPU P State Control

P State Domain

This feature allows the user to indicate the P-State domain for each logical process in the system. All processes indicate the same domain in the same package. The options are **ALL** and **ONE**.

P-State Coordination

This feature allows the user to change the P-State (Power-Performance State) coordination type. P-State is also known as "SpeedStep" for Intel processors. Select **HW_ALL** to change the P-State coordination type for hardware components only. Select **SW_ALL** to change the P-State coordination type for all software installed in the system. Select **SW_ANY** to change the P-State coordination type for a software program in the system. The options are **HW_All**, **SW_ALL**, and **SW_ANY**.

Energy Efficient P-State

Select **Enable** to support power-saving mode for P-State. The options are **Disable** and **Enable**.

Boot Performance Mode

This feature allows the user to select the performance state that the BIOS will set before the operating system handoff. The options are **Max Performance** and **Max Efficient**.

Turbo Mode

Select **Enable** for processor cores to run faster than the frequency specified by the manufacturer. The options are **Disable** and **Enable**.

► CPU HWPM State Control

Enable CPU HWPM

Select Enable for better CPU energy performance. The options are **Disable**, HWPM NATIVE MODE, and HWPM OOB MODE.

Enable CPU Autonomous Cstate

Use this feature to enable CPU Autonomous C State, which converts HALT instructions to Mwait. The options are **Disable** and Enable.

► CPU C State Control

CPU C State

Use this feature to enable the enhanced C State of the CPU. The options are Disable and **Enable**.

Package C State Limit

This feature allows the user to set the limit on the C State package register. The options are C0/C1 State, C2 State, C6 (Non Retention) State, **C6 (Retention) state**, and No Limit.

CPU C3 Report

Select Enabled to allow the BIOS to report the CPU C3 State (ACPI C2) to the operating system. During the CPU C3 State, the CPU clock generator is turned off. The options are Enable and **Disable**.

CPU C6 Report

Select Enabled to allow the BIOS to report the CPU C6 State (ACPI C3) to the operating system. During the CPU C6 State, the power to all cache is turned off. The options are **Enable** and Disable.

Enhanced Halt State (C1E)

Select Enabled to use Enhanced Halt-State technology, which will significantly reduce the CPU's power consumption by reducing the CPU's clock cycle and voltage during a Halt-state. The options are Disable and **Enable**.

► CPU T State Control

ACPI (Advanced Configuration Power Interface) T-States

Select Enable to support CPU throttling by the operating system to reduce power consumption. The options are Enable and **Disable**.

► CPU Advanced PM Tuning

► Energy Perf BIAS

Energy Performance Tuning

When enabled, this item selects whether the BIOS or Operating System can turn on the energy performance bias tuning. The options are **Enable** and **Disable**.

If the above is set to Disable, Energy Performance BIAS Setting will display:

Energy Performance BIAS Setting

This feature allows balancing Power Efficiency vs Performance. This will override whatever setting is in the Operating System. The options are Performance, **Balanced Performance**, Balanced Power, and Power.

Power/Performance Switch

This feature allows dynamic switching between Power and Performance power efficiency. The options are **Enable** and **Disable**.

Workload Configuration

This feature allows for optimization of workload. Balanced is recommended. The options are **Balanced** and I/O Sensitive.

► Program PowerCTL_MSR

PKG C-state Lat. Neg.

Use this feature to indicate whether latency should be negotiated with PCH for packaging C-States. The options are **Enable** and **Disable**.

SAPM Control

This feature indicates whether the PCU should control the System Agent PM using its power-performance tuning algorithm. The options are **Enable** and **Disable**.

Energy Efficient Turbo

Use this feature to enable energy efficient turbo mode. The options are **Enable** and **Disable**.

► DRAM RAPL Configuration

Override BW_LIMIT_TF

Use this feature to set the value for the custom tuning of BW_LIMIT_TF. The default value is 1.

DRAM RAPL Extended Range

Use this feature to set the DRAM Running Average Power Limit (RAPL) Extended Range. The options are Disable and **Enable**.

► Chipset Configuration

Warning: Setting the wrong values in the following features may cause the system to malfunction.

► North Bridge

This feature allows the user to configure the following North Bridge settings.

► IIO Configuration

EV DFX (Device Function On-Hide) Features

When this feature is set to Enable, the EV_DFX Lock Bits that are located on a processor will always remain clear during electric tuning. The options are **Disable** and Enable.

► IIO1 Configuration

M.2 PCI-E 3.0 X4

This item configures the link speed of the PCI-E port specified by the user. The options are Gen 1 (Generation 1) (2.5 GT/s), Gen 2 (Generation 2) (5 GT/s) and **Gen 3 (Generation 3) (8 GT/s)**.

SLOT 7 PCI-E 3.0 X16

This item configures the link speed of the PCI-E port specified by the user. The options are Gen 1 (Generation 1) (2.5 GT/s), Gen 2 (Generation 2) (5 GT/s) and **Gen 3 (Generation 3) (8 GT/s)**.

► IOAT (Intel[®] IO Acceleration) Configuration

Enable IOAT

Select Enable to enable Intel I/OAT (I/O Acceleration Technology) support, which significantly reduces CPU overhead by leveraging CPU architectural improvements and freeing the system resource for other tasks. The options are Disable and **Enable**.

No Snoop

Select Enable to support no-snoop mode for each CB device. The options are **Disable** and Enable.

► Intel[®] VT for Directed I/O (VT-d)

Intel[®] VT for Directed I/O (VT-d)

Select Enable to use Intel[®] Virtualization Technology support for Direct I/O VT-d support by reporting the I/O device assignments to the VMM (Virtual Machine Monitor) through the DMAR ACPI Tables. This feature offers fully-protected I/O resource sharing across Intel platforms, providing greater reliability, security and availability in networking and data-sharing. The options are **Enable** and Disable.

ACS Control

Use this feature to program Access Control Services (ACS) to the PCI-E Root Port Bridges. The options are **Enable** and Disable.

Interrupt Remapping

Select Enable for Interrupt Remapping support to enhance system performance. The options are **Enable** and Disable.

► Memory Configuration

Enforce POR

Select Enable to enforce POR restrictions on DDR4 frequency and voltage programming. The options are **Enabled** and Disabled.

Memory Frequency

Use this feature to set the maximum memory frequency for onboard memory modules. The options are **Auto**, 1333, 1400, 1600, 1800, 1867, 2000, 2133, 2200, 2400, 2600, 2667, and Reserved (Do not select Reserved).

Data Scrambling

Select Enabled to enable data scrambling to enhance system performance and data integrity. The options are **Auto**, Disabled and Enabled.

DRAM RAPL Baseline

Use this feature to set the run-time power-limit baseline for DRAM modules. The options are Disable, DRAM RAPL Mode 0, and **DRAM RAPL Mode 1**.

Set Throttling Mode

Throttling improves reliability and reduces power consumption in the processor via automatic voltage control during processor idle states. The options are Disabled and **CLTT** (Closed Loop Thermal Throttling).

A7 Mode

Select Enabled to support the A7 (Addressing) mode to improve memory performance. The options are **Enable** and Disable.

►DIMM Information

This item displays the status of a DIMM module specified by the user.

- DIMMA1
- DIMMB1
- DIMMA2
- DIMMB2

►Memory RAS (Reliability_Availability_Serviceability) Configuration

Use this submenu to configure the following Memory RAS settings.

Patrol Scrub

Patrol Scrubbing is a process that allows the CPU to correct correctable memory errors detected on a memory module and send the correction to the requestor (the original source). When this item is set to Enabled, the IO hub will read and write back one cache line every 16K cycles, if there is no delay caused by internal processing. By using this method, roughly 64 GB of memory behind the IO hub will be scrubbed every day. The options are **Enable** and Disable.

Patrol Scrub Interval

This feature allows you to decide how many hours the system should wait before the next complete patrol scrub is performed. Use the keyboard to enter a value from 0-24. The Default setting is **24**.

Demand Scrub

Demand Scrubbing is a process that allows the CPU to correct correctable memory errors found on a memory module. When the CPU or I/O issues a demand-read command, and the read data from memory turns out to be a correctable error, the error is corrected and sent to the requestor (the original source). Memory is updated as well. Select **Enable** to use Demand Scrubbing for ECC memory correction. The options are **Enable** and **Disable**.

Device Tagging

Select **Enable** to support device tagging. The options are **Disable** and **Enable**.

► South Bridge

The following South Bridge information will display:

- USB Configuration
- USB Module Version
- USB Devices

Legacy USB Support

This feature enables support for legacy USB devices. Select **Auto** to disable legacy support if USB devices are not present. Select **Disable** to have USB devices available only for EFI applications. The options are **Enabled**, **Disabled** and **Auto**.

XHCI Hand-Off

This is a work-around solution for operating systems that do not support XHCI (Extensible Host Controller Interface) hand-off. The XHCI ownership change should be claimed by the XHCI driver. The settings are **Enabled** and **Disabled**.

EHCI Hand-Off

This item is for the Operating Systems that do not support Enhanced Host Controller Interface (EHCI) hand-off. When this item is enabled, EHCI ownership change will be claimed by the EHCI driver. The settings are **Enabled** and **Disabled**.

Port 60/64 Emulation

This feature enables or disables I/O port 60h/64h emulation support. This should be enabled for complete USB keyboard legacy support for non-USB-aware Operating Systems. The options are Disabled and **Enabled**.

USB 3.0 Support

Select Enabled for USB 3.0 support. The options are Smart Auto, **Auto**, Disabled, and Enabled.

EHCI1

Select Enabled to enable EHCI (Enhanced Host Controller Interface) support on USB 2.0 connector #1 (at least one USB 2.0 connector should be enabled for EHCI support). The options are Disabled and **Enabled**.

EHCI2

Select Enabled to enable EHCI (Enhanced Host Controller Interface) support on USB 2.0 connector #2 (at least one USB 2.0 connector should be enabled for EHCI support). The options are Disabled and **Enabled**.

XHCI Pre-Boot Driver

Select Enabled to enable XHCI (Extensible Host Controller Interface) support on a pre-boot drive specified by the user. The options are Enabled and **Disabled**.

► SATA Configuration

When this submenu is selected, the AMI BIOS automatically detects the presence of the SATA devices that are supported by the Intel PCH chip and displays the following items:

SATA Controller

This item enables or disables the onboard SATA controller supported by the Intel PCH chip. The options are **Enabled** and Disabled.

Configure SATA as

Select IDE to configure a SATA drive specified by the user as an IDE drive. Select AHCI to configure a SATA drive specified by the user as an AHCI drive. Select RAID to configure a SATA drive specified by the user as a RAID drive. The options are IDE, **AHCI**, and RAID.

****If the item above "Configure SATA as" is set to AHCI, the following items will display:***

SATA Frozen

Use this item to enable the HDD Security Frozen Mode. The options are Enabled and **Disabled**.

SATA AHCI LPM

Use this feature to enable the Link Power Management for SATA AHCI. The options are Disabled and **Enabled**.

Support Aggressive Link Power Management

When this item is set to Enabled, the SATA AHCI controller manages the power usage of the SATA link. The controller will put the link in a low power mode during extended periods of I/O inactivity, and will return the link to an active state when I/O activity resumes. The options are **Enabled** and Disabled.

SATA Port 0~ Port 5

This item displays the information detected on the installed SATA drive on the particular SATA port.

- Model number of drive and capacity
- Software Preserve Support

Port 0 ~ Port 5 Hot Plug

This feature designates this port for hot plugging. Set this item to Enabled for hot-plugging support, which will allow the user to replace a SATA drive without shutting down the system. The options are **Enabled** and Disabled.

Port 0 ~ Port 5 Spin Up Device

On an edge detect from 0 to 1, set this item to allow the PCH to initialize the device. The options are Enabled and **Disabled**.

Port 0 ~ Port 5 SATA Device Type

Use this item to specify if the connected SATA device is a Solid State drive or a Hard Disk Drive. The options are **Hard Disk Drive** and Solid State Drive.

****If the item above "Configure SATA as" is set to IDE, the following items will display:***

Port 0 ~ Port 5 SATA Device Type (Available when a SATA port is detected)

Use this item to specify if the connected SATA device is a Solid State drive or a Hard Disk Drive. The options are **Hard Disk Drive** and Solid State Drive.

► Server ME (Management Engine) Configuration

This feature displays the following system ME configuration settings.

- General ME Configuration
- Operational Firmware Version
- ME Firmware Type
- Recovery Firmware Version
- ME Firmware Features
- ME Firmware Status #1
- ME Firmware Status #2
 - Current State
 - Error Code

► PCIe/PCI/PnP Configuration

The following information will display:

- PCI Bus Driver Version
- PCI Devices Common Settings:

PCI PERR/SERR Support

Select Enabled to allow a PCI device to generate a PERR/SERR number for a PCI Bus Signal Error Event. The options are Enabled and **Disabled**.

Above 4G Decoding (Available if the system supports 64-bit PCI decoding)

Select Enabled to decode a PCI device that supports 64-bit in the space above 4G Address. The options are Enabled and **Disabled**.

SR-IOV (Available if the system supports Single-Root Virtualization)

Select Enabled for Single-Root IO Virtualization support. The options are Enabled and **Disabled**.

*Onboard 10GbE LAN SR-IOV not supported on D-1540/D-1520.

Maximum Payload

Use this feature to select the setting for the PCI Express maximum payload size. The options are **Auto**, 128 Bytes, 256 Bytes, 512 Bytes, 1024 Bytes, 2048 Bytes, and 4096 Bytes.

Relaxed Ordering

Select Enable to enable Relaxed Ordering support which will allow certain transactions to violate the strict-ordering rules of PCI bus for a transaction to be completed prior to other transactions that have already been enqueued. The options are Enabled and **Disabled**.

Extended Tag

Use this item to allow a device to use the 8-bit tag field as a requester. The options are **Disabled** and Enabled.

ARI Forwarding

When this feature is enabled, the Downstream Port disables its traditional device number to 0 when turning Type1 Configuration Request into a Type0 Configuration Request. The default value is **Disabled**.

M.2 PCI-E 3.0 X4 OPROM

Use this feature to select which firmware type to be loaded for the add-on card in this slot. The options are Disabled, **Legacy**, and EFI.

SLOT 7 PCI-E 3.0 X16 Bifurcation

Use this feature to set the PCI-E slot to operate as a single x16 slot or to bifurcate into two x8 slots. A proper riser card must be used to take advantage of bifurcation. The options are x8x8 and **x16**.

SLOT 7 PCI-E 3.0 X16 OPROM

Use this feature to select which firmware type to be loaded for the add-on card in this slot. The options are Disabled, **Legacy**, and EFI.

Onboard LAN Option ROM Type

Use this option to enable Option ROM support to boot the computer using a network device specified by the user. The options are **Legacy** and EFI.

Onboard LAN1 Option ROM

Use this option to select the type of device installed in LAN Port 1 used for system boot. The options are Disabled, **PXE**, and iSCSI.

Onboard LAN2 Option ROM

Use this option to select the type of device installed in LAN Port 2 used for system boot. The options are **Disabled** and PXE.

Onboard LAN3 Option ROM

Use this option to select the type of device installed in LAN Port 3 used for system boot. The options are **Disabled** and PXE.

Onboard LAN4 Option ROM

Use this option to select the type of device installed in LAN Port 4 used for system boot. The options are **Disabled** and PXE.

Onboard Video Option ROM

Use this item to select the Onboard Video Option ROM type. The options are Disabled, **Legacy**, and EFI.

VGA Priority

This feature allows the user to select the graphics adapter to be used as the primary boot device. The options are **Onboard** and Offboard.

Network Stack

Use this feature to enable PXE (Preboot Execution Environment) or UEFI (Unified Extensible Firmware Interface) for network stack support. The options are **Disabled** and Enabled.

****If the item above set to Enabled, the four items below will appear:***

IPv4 PXE Support

Use this feature to enable IPv4 PXE boot support. The options are **Enabled** and Disabled.

IPv6 PXE Support

Use this feature to enable IPv6 PXE boot support. The options are **Enabled** and Disabled.

PXE boot wait time

Use this option to specify the number of times media will be checked. Press "+" or "-" on your keyboard to change the value. The default setting is **0**.

Media detect count

Use this option to specify the number of times media will be checked. Press "+" or "-" on your keyboard to change the value. The default setting is **1**.

► Super IO Configuration

Super IO Chip AST2400

► Serial Port 1 Configuration

This submenu allows the user the configure settings of Serial Port 1.

Serial Port

Select Enabled to enable the selected onboard serial port. The options are **Enabled** and Disabled.

Device Settings

This item displays the status of a serial part specified by the user.

Change Port 1 Settings

This feature specifies the base I/O port address and the Interrupt Request address of a serial port specified by the user. Select Auto to allow the BIOS to automatically assign the base I/O and IRQ address. The options for Serial Port 1 are **Auto**, (IO=3F8h; IRQ=4), (IO=3F8h; IRQ=3, 4, 5, 6, 7, 9, 10, 11, 12), (IO=2F8h; IRQ=3, 4, 5, 6, 7, 9, 10, 11, 12), (IO=3E8h; IRQ=3, 4, 5, 6, 7, 9, 10, 11, 12) and (IO=2E8h; IRQ=3, 4, 5, 6, 7, 9, 10, 11, 12).

► Serial Port Console Redirection

COM1 Console Redirection

Console Redirection

Select Enabled to enable console redirection support for a serial port specified by the user. The options are Enabled and **Disabled**.

► COM1 Console Redirection Settings

This feature allows the user to specify how the host computer will exchange data with the client computer, which is the remote computer used by the user.

Terminal Type

This feature allows the user to select the target terminal emulation type for Console Redirection. Select VT100 to use the ASCII Character set. Select VT100+ to add color and function key support. Select ANSI to use the Extended ASCII Character Set. Select VT-UTF8 to use UTF8 encoding to map Unicode characters into one or more bytes. The options are ANSI, VT100, **VT100+**, and VT-UTF8.

Bits Per second

Use this feature to set the transmission speed for a serial port used in Console Redirection. Make sure that the same speed is used in the host computer and the client computer. A lower transmission speed may be required for long and busy lines. The options are 9600, 19200, 38400, 57600 and **115200** (bits per second).

Data Bits

Use this feature to set the data transmission size for Console Redirection. The options are 7 Bits and **8 Bits**.

Parity

A parity bit can be sent along with regular data bits to detect data transmission errors. Select Even if the parity bit is set to 0, and the number of 1's in data bits is even. Select Odd if the parity bit is set to 0, and the number of 1's in data bits is odd. Select None if you do not want to send a parity bit with your data bits in transmission. Select Mark to add a mark as a parity bit to be sent along with the data bits. Select Space to add a Space as a parity bit to be sent with your data bits. The options are **None**, Even, Odd, Mark and Space.

Stop Bits

A stop bit indicates the end of a serial data packet. Select 1 Stop Bit for standard serial data communication. Select 2 Stop Bits if slower devices are used. The options are **1** and 2.

Flow Control

Use this feature to set the flow control for Console Redirection to prevent data loss caused by buffer overflow. Send a "Stop" signal to stop sending data when the receiving buffer is full. Send a "Start" signal to start sending data when the receiving buffer is empty. The options are **None** and Hardware RTS/CTS.

VT-UTF8 Combo Key Support

Select Enabled to enable VT-UTF8 Combination Key support for ANSI/VT100 terminals. The options are **Enabled** and Disabled.

Recorder Mode

Select Enabled to capture the data displayed on a terminal and send it as text messages to a remote server. The options are **Disabled** and Enabled.

Resolution 100x31

Select Enabled for extended-terminal resolution support. The options are Disabled and **Enabled**.

Legacy OS Redirection Resolution

Use this feature to select the number of rows and columns used in Console Redirection for legacy OS support. The options are 80x24 and **80x25**.

Putty KeyPad

This feature selects the settings for Function Keys and KeyPad used for Putty, which is a terminal emulator designed for the Windows OS. The options are **VT100**, LINUX, XTERMR6, SC0, ESCN, and VT400.

Redirection After BIOS POST

Use this feature to enable or disable legacy console redirection after BIOS POST. When set to Bootloader, legacy console redirection is disabled before booting the OS. When set to Always Enable, legacy console redirection remains enabled when booting the OS. The options are **Always Enable** and Bootloader.

SOL Console Redirection

Select Enabled to use the SOL port for Console Redirection. The options are **Enabled** and Disabled.

**If the item above set to Enabled, the following items will become available for user's configuration:*

► SOL Console Redirection Settings

Use this feature to specify how the host computer will exchange data with the client computer, which is the remote computer used by the user.

Terminal Type

Use this feature to select the target terminal emulation type for Console Redirection. Select VT100 to use the ASCII Character set. Select VT100+ to add color and function key support. Select ANSI to use the Extended ASCII Character Set. Select VT-UTF8 to use UTF8 encoding to map Unicode characters into one or more bytes. The options are ANSI, VT100, **VT100+**, and VT-UTF8.

Bits Per second

Use this feature to set the transmission speed for a serial port used in Console Redirection. Make sure that the same speed is used in the host computer and the client computer. A lower transmission speed may be required for long and busy lines. The options are 9600, 19200, 38400, 57600 and **115200** (bits per second).

Data Bits

Use this feature to set the data transmission size for Console Redirection. The options are 7 (Bits) and **8 (Bits)**.

Parity

A parity bit can be sent along with regular data bits to detect data transmission errors. Select Even if the parity bit is set to 0, and the number of 1's in data bits is even. Select Odd if the parity bit is set to 0, and the number of 1's in data bits is odd. Select None if you do not want to send a parity bit with your data bits in transmission. Select Mark to add a mark as a parity bit to be sent along with the data bits. Select Space to add a Space as a parity bit to be sent with your data bits. The options are **None**, Even, Odd, Mark and Space.

Stop Bits

A stop bit indicates the end of a serial data packet. Select 1 Stop Bit for standard serial data communication. Select 2 Stop Bits if slower devices are used. The options are **1** and **2**.

Flow Control

Use this feature to set the flow control for Console Redirection to prevent data loss caused by buffer overflow. Send a "Stop" signal to stop sending data when the receiving buffer is full. Send a "Start" signal to start sending data when the receiving buffer is empty. The options are **None** and Hardware RTS/CTS.

VT-UTF8 Combo Key Support

Select Enabled to enable VT-UTF8 Combination Key support for ANSI/VT100 terminals. The options are **Enabled** and Disabled.

Recorder Mode

Select Enabled to capture the data displayed on a terminal and send it as text messages to a remote server. The options are **Disabled** and Enabled.

Resolution 100x31

Select Enabled for extended-terminal resolution support. The options are Disabled and **Enabled**.

Legacy OS Redirection Resolution

Use this feature to select the number of rows and columns used in Console Redirection for legacy OS support. The options are 80x24 and **80x25**.

Putty KeyPad

This feature selects Function Keys and KeyPad settings for Putty, which is a terminal emulator designed for the Windows OS. The options are **VT100**, LINUX, XTERMR6, SCO, ESCN, and VT400.

Redirection After BIOS POST

Use this feature to enable or disable legacy Console Redirection after BIOS POST. When set to Bootloader, legacy Console Redirection is disabled before booting the OS. When set to Always Enable, legacy Console Redirection remains enabled when booting the OS. The options are **Always Enable** and Bootloader.

Serial Port for Out-of-Band Management/Windows Emergency Management Services (EMS)

The submenu allows the user to configure Console Redirection settings to support Out-of-Band Serial Port management.

EMS (Emergency Management Services) Console Redirection

Select Enabled to use a COM port selected by the user for EMS Console Redirection. The options are Enabled and **Disabled**.

**If the item above set to Enabled, the following items will become available for user's configuration:*

►EMS Console Redirection Settings

This feature allows the user to specify how the host computer will exchange data with the client computer, which is the remote computer used by the user.

Out-of-Band Mgmt Port

The feature selects a serial port in a client server to be used by the Microsoft Windows Emergency Management Services (EMS) to communicate with a remote host server. The options are **COM1** and SOL.

Terminal Type

Use this feature to select the target terminal emulation type for Console Redirection. Select VT100 to use the ASCII character set. Select VT100+ to add color and function key support. Select ANSI to use the extended ASCII character set. Select VT-UTF8 to use UTF8 encoding to map Unicode characters into one or more bytes. The options are ANSI, VT100, VT100+, and **VT-UTF8**.

Bits Per Second

This item sets the transmission speed for a serial port used in Console Redirection. Make sure that the same speed is used in the host computer and the client computer. A lower transmission speed may be required for long and busy lines. The options are 9600, 19200, 57600, and **115200** (bits per second).

Flow Control

Use this item to set the flow control for Console Redirection to prevent data loss caused by buffer overflow. Send a "Stop" signal to stop sending data when the receiving buffer is full. Send a "Start" signal to start sending data when the receiving buffer is empty. The options are **None**, Hardware RTS/CTS, and Software Xon/Xoff.

Data Bits

Parity

Stop Bits

► ACPI Settings

WHEA Support

This feature Enables the Windows Hardware Error Architecture (WHEA) support for the Windows 2008 (or a later version) operating system. The options are **Enabled** and Disabled.

High Precision Event Timer

Use this feature to activate the High Performance Event Timer (HPET) that produces periodic interrupts at a much higher frequency than a Real-time Clock (RTC) does in synchronizing multimedia streams, providing smooth playback and reducing the dependency on other timestamp calculation devices, such as an x86 RDTSC Instruction embedded in the CPU. The High Performance Event Timer is used to replace the 8254 Programmable Interval Timer. The options are **Enabled** and Disabled.

PCI AER Support

Use this feature to enable the ACPI OS to manage PCI Advanced Error Reporting. The options are Enabled and **Disabled**.

► Trusted Computing (Available when a TPM Device is Detected and TPM Jumper is Enabled)

Configuration

Security Device Support

Select Enable for the AMI BIOS to automatically download the drivers needed to provide Trusted Computing platform support for this machine to ensure date integrity and network security. The options are **Disable** and Enable.

TPM State

Select Enabled to use TPM (Trusted Platform Module) settings for system data security. The options are Disabled and **Enabled**.



Note: The system will reboot for the change on TPM State to take effect.

Pending Operation

Use this item to schedule a TPM-related operation to be performed by a security device for TPM support. The options are **None**, Enable Take Ownership, Disable Take Ownership, and TPM Clear.



Note: The computer will reboot to carry out a pending TPM operation and change TPM state for a TPM device.

Current Status Information

This feature indicates the status of the following TPM items:

TPM Enabled Status

TPM Active Status

TPM Owner Status

Intel TXT (LT-SX) Configuration

TXT Support

Intel TXT (Trusted Execution Technology) helps protect against software-based attacks to ensure the security, confidentiality, and integrity of all data stored in the system. The options are Enabled and **Disabled**.

4-4 Event Logs

Use this feature to configure Event Log settings.

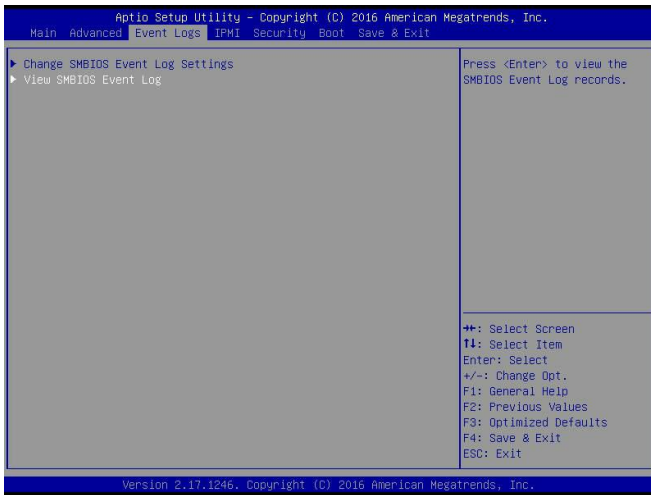

► Change SMBIOS Event Log Settings

Enabling/Disabling Options

SMBIOS Event Log

Change this item to enable or disable all features of the SMBIOS Event Logging during system boot. The options are **Enabled** and Disabled.

Runtime Error Logging Support

Use this feature to enable Runtime Error Logging support. The options are **Enable** and Disable. If this item is set to Enable, the following item will be available for configuration:

Memory Corrected Error Enabling (Available when the item above - Runtime Error Logging Support is set to Enable)

Select Enable for the BIOS to correct a memory error if it is correctable. The options are Disable and **Enable**.

Memory Corr. Error Threshold

Use this item to enter the threshold value for correctable memory errors. The default setting is **10**.

PCI-Ex Error Enable

Select Yes for the BIOS to correct errors occurred in the PCI-E slots. The options are Yes and **No**.

Erasing Settings

Erase Event Log

If No is selected, data stored in the event log will not be erased. If Yes, Next Reset is selected, data in the event log will be erased upon next system reboot. If Yes, Every Reset is selected, data in the event log will be erased upon every system reboot. The options are **No**, Yes, Next reset, and Yes, Every reset.

When Log is Full

Select Erase Immediately for all messages to be automatically erased from the event log when the event log memory is full. The options are **Do Nothing** and Erase Immediately.

SMBIOS Event Long Standard Settings

Log System Boot Event

This option toggles the System Boot Event logging to enabled or disabled. The options are **Disabled** and Enabled.

MECI

The Multiple Event Count Increment (MECI) counter counts the number of occurrences that a duplicate event must happen before the MECI counter is incremented. This is a numeric value. The default value is **1**.

METW

The Multiple Event Time Window (METW) defines number of minutes must pass between duplicate log events before MECI is incremented. This is in minutes, from 0 to 99. The default value is **60**.



Note: After making changes on a setting, be sure to reboot the system for the changes to take effect.

►View SMBIOS Event Log

This section displays the contents of the SMBIOS Event Log.

4-5 IPMI

Use this feature to configure Intelligent Platform Management Interface (IPMI) settings.



BMC Firmware Revision

This item indicates the IPMI firmware revision used in your system.

IPMI Status (Baseboard Management Controller)

This item indicates the status of the IPMI firmware installed in your system.

► System Event Log

Enabling/Disabling Options

SEL Components

Select Enabled for all system event logging at bootup. The options are **Enabled** and Disabled.

Erasing Settings

Erase SEL

Select Yes, On next reset to erase all system event logs upon next system reboot.
 Select Yes, On every reset to erase all system event logs upon each system reboot.
 Select No to keep all system event logs after each system reboot. The options are **No**, Yes, On next reset, and Yes, On every reset.

When SEL is Full

This feature allows the user to decide what the BIOS should do when the system event log is full. Select Erase Immediately to erase all events in the log when the system event log is full. The options are **Do Nothing** and Erase Immediately.



Note: After making changes on a setting, be sure to reboot the system for the changes to take effect.

►BMC Network Configuration

BMC Network Configuration

IPMI LAN Selection

This item displays the IPMI LAN setting. The default setting is **Failover**.

IPMI Network Link Status

This item displays the IPMI Network Link status. The default setting is **Dedicated LAN**.

Update IPMI LAN Configuration

Select Yes for the BIOS to implement all IP/MAC address changes at the next system boot. The options are **No** and Yes

Configuration Address Source

This feature allows the user to select the source of the IP address for this computer. If Static is selected, you will need to know the IP address of this computer and enter it to the system manually in the field. If DHCP is selected, the BIOS will search for a DHCP (Dynamic Host Configuration Protocol) server in the network that is attached to and request the next available IP address for this computer. The options are **DHCP** and Static. The following items are assigned IP addresses automatically if DHCP is selected.

Current Configuration Address Source

This item displays the current configuration address for this computer.

Station IP Address

This item displays the Station IP address for this computer. This should be in decimal and in dotted quad form (i.e., 192.168.10.253).

Subnet Mask

This item displays the sub-network that this computer belongs to. The value of each three-digit number separated by dots should not exceed 255.

Station MAC Address

This item displays the Station MAC address for this computer. Mac addresses are 6 two-digit hexadecimal numbers.

Gateway IP Address

This item displays the Gateway IP address for this computer. This should be in decimal and in dotted quad form (i.e., 172.31.0.1).

IPMI Function Support

Use this feature to enable or disable IPMI support within the BIOS. The options are **Enabled** and Disabled. When Disabled, the motherboard powers on quickly by removing BIOS control for extended IPMI features. The Disable option is for applications that require faster power on time without using Supermicro Update Manager (SUM) or extended IPMI features. The BMC network configuration in the BIOS setup is also invalid when IPMI Function Support is disabled. General BMC function and motherboard health monitor such as temperature and fan control are still active even when this option is disabled.

4-6 Security

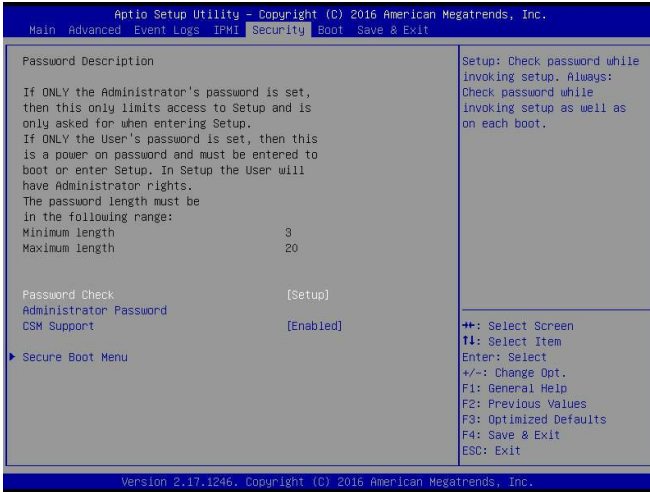

This menu allows the user to configure the following security settings for the system.

Password Check

Select Setup for the system to check for a password at Setup. Select Always for the system to check for a password at bootup or upon entering the BIOS Setup utility. The options are **Setup** and Always.

Administrator Password

Press Enter to create a new, or change an existing Administrator password.

CSM Support

Select Enabled to support the EFI Compatibility Support Module (CSM), which provides compatibility support for traditional legacy BIOS for system boot. The options are **Enabled** and Disabled. The options are **Enabled** and Disabled.

►Secure Boot Menu

This section displays the contents of the following secure boot features:

- System Mode

- Secure Boot
- Vendor Keys

Secure Boot

Use this item to enable secure boot. The options are **Disabled** and Enabled.

Secure Boot Mode

Use this item to select the secure boot mode. The options are Standard and **Custom**.

► Key Management

This submenu allows the user to configure the following Key Management settings.

Factory Default Key Provision

Select Enabled to install the default Secure Boot keys set by the manufacturer. The options are **Disabled** and Enabled.

► Enroll All Factory Default Keys

Select Yes to install all default secure keys set by the manufacturer. The options are **Yes** and No.

Save All Secure Boot Variables

This feature allows the user to decide if all secure boot variables should be saved.

► Platform Key (PK)

This feature allows the user to configure the settings of the platform keys.

Set New Key

Select Yes to load the new platform keys (PK) from the manufacturer's defaults. Select No to load the platform keys from a file. The options are **Yes** and No.

► Key Exchange Key (KEK)

Set New Key

Select Yes to load the KEK from the manufacturer's defaults. Select No to load the KEK from a file. The options are Yes and No.

Append Key

Select Yes to add the KEK from the manufacturer's defaults list to the existing KEK. Select No to load the KEK from a file. The options are Yes and No.

► Authorized Signatures

Set New Key

Select Yes to load the database from the manufacturer's defaults. Select No to load the DB from a file. The options are Yes and No.

Append Key

Select Yes to add the database from the manufacturer's defaults to the existing DB. Select No to load the DB from a file. The options are Yes and No.

► Forbidden Signatures

Set New Key

Select Yes to load the DBX from the manufacturer's defaults. Select No to load the DBX from a file. The options are Yes and No.

Append New Key

Select Yes to add the DBX from the manufacturer's defaults to the existing DBX. Select No to load the DBX from a file. The options are Yes and No.

► Authorized TimeStamps

Set New Key

Select Yes to load the DBT from the manufacturer's defaults. Select No to load the DBT from a file. The options are Yes and No.

Append Key

Select Yes to add the DBT from the manufacturer's defaults list to the existing DBT. Select No to load the DBT from a file. The options are Yes and No.

4-7 Boot Settings

Use this feature to configure Boot Settings:

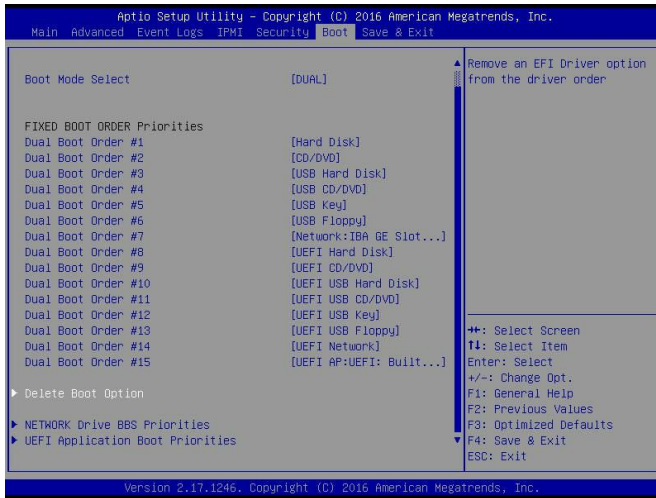

Setup Prompt Timeout

Use this item to indicate the length of time (the number of seconds) for the BIOS to wait before rebooting the system when the setup activation key is pressed. Enter the value of 65535 (0xFFFF) for the BIOS to wait indefinitely. The default setting is 1.

Boot Mode Select

Use this item to select the type of device that the system is going to boot from. The options are Legacy, UEFI, and **Dual**. The default setting is Dual.

Fixed Boot Order Priorities

This option prioritizes the order of bootable devices that the system to boot from. Press <Enter> on each entry from top to bottom to select devices.

- Dual Boot Order #1
- Dual Boot Order #2
- Dual Boot Order #3
- Dual Boot Order #4
- Dual Boot Order #5

- Dual Boot Order #6
- Dual Boot Order #7
- Dual Boot Order #8
- Dual Boot Order #9
- Dual Boot Order #10
- Dual Boot Order #11
- Dual Boot Order #12
- Dual Boot Order #13
- Dual Boot Order #14
- Dual Boot Order #15

▶ **Delete Boot Option**

Use this feature to remove a pre-defined boot device from which the system will boot during startup.

The settings are [any pre-defined boot device].

▶ **Network Drive BBS Priorities**

This feature allows the user to specify which Network devices are boot devices.

- Legacy Boot Order #1

▶ **UEFI Applicatoin Boot Priorities**

This feature allows the user to specify which UEFI devices are boot devices.

- UEFI Boot Order #1

4-8 Save & Exit

Select the Exit tab from the BIOS setup utility screen to enter the Exit BIOS Setup screen.

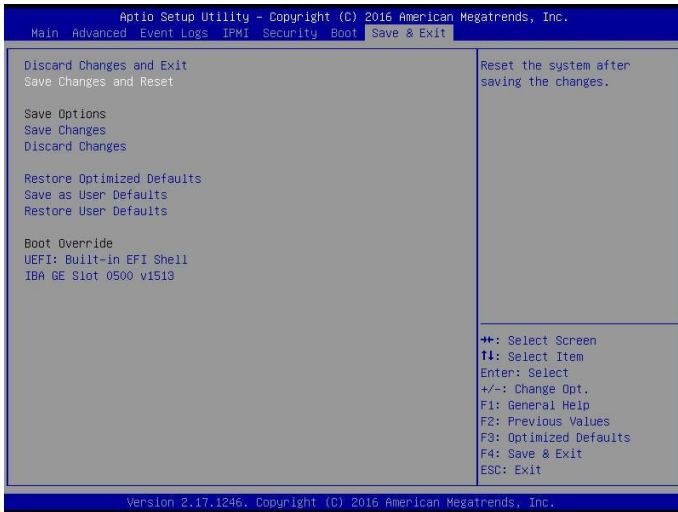

Discard Changes and Exit

Select this option to quit the BIOS Setup without making any permanent changes to the system configuration, and reboot the computer. Select Discard Changes and Exit from the Exit menu and press <Enter>.

Save Changes and Reset

When you have completed the system configuration changes, select this option to leave the BIOS setup utility and reboot the computer, so the new system configuration parameters can take effect. Select Save Changes and Exit from the Exit menu and press <Enter>.

Save Options

Save Changes

After completing the system configuration changes, select this option to save the changes you have made. This will not reset (reboot) the system.

Discard Changes

Select this option and press <Enter> to discard all the changes and return to the AMI BIOS utility Program.

Restore Defaults

To set this feature, select Restore Defaults from the Save & Exit menu and press <Enter>. These are factory settings designed for maximum system stability, but not for maximum performance.

Save As User Defaults

To set this feature, select Save as User Defaults from the Exit menu and press <Enter>. This enables the user to save any changes to the BIOS setup for future use.

Restore User Defaults

To set this feature, select Restore User Defaults from the Exit menu and press <Enter>. Use this feature to retrieve user-defined settings that were saved previously.

Appendix A

BIOS Error Beep Codes

During the POST (Power-On Self-Test) routines, which are performed each time the system is powered on, errors may occur.

Non-fatal errors are those which, in most cases, allow the system to continue with bootup. The error messages normally appear on the screen.

Fatal errors will not allow the system to continue to bootup. If a fatal error occurs, you should consult with your system manufacturer for possible repairs.

These fatal errors are usually communicated through a series of audible beeps. The numbers on the fatal error list correspond to the number of beeps for the corresponding error.

A-1 BIOS Error Beep Codes

 **Note:** A PC buzzer must be installed via JD1 to hear the BIOS Error Beep Codes.

BIOS Error Beep Codes		
Beep Code/LED	Error Message	Description
1 beep	Refresh	Circuits have been reset. (Ready to power up)
5 short beeps + 1 long beep	Memory error	No memory detected in the system
8 beeps	Display memory read/write error	Video adapter missing or with faulty memory
OH LED On	System OH	System Overheat

Notes

Appendix B

Software Installation Instructions

B-1 Installing Software Programs

The Supermicro ftp site contains drivers and utilities for your system at <ftp://ftp.supermicro.com>. Some of these must be installed, such as the chipset driver.

After accessing the ftp site, go into the CDR_Images directory and locate the ISO file for your motherboard. Download this file to create a CD/DVD of the drivers and utilities it contains. (You may also use a utility to extract the ISO file if preferred.)

Another option is to go to the Supermicro website at <http://www.supermicro.com/products/>. Find the product page for your motherboard here, where you may download individual drivers and utilities.

After creating a CD/DVD with the ISO files, insert the disk into the CD/DVD drive on your system and the display shown below should appear.

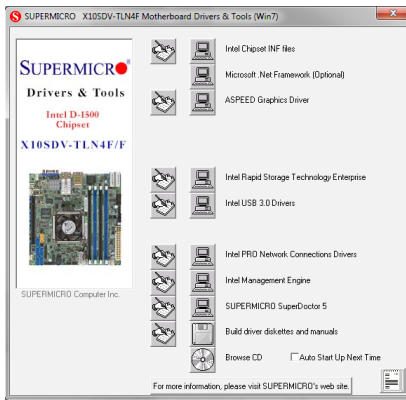

Driver/Tool Installation Display Screen

Note 1: Click the icons showing a hand writing on paper to view the readme files for each item. Click the computer icons to the right of these items to install each item (from top to the bottom) one at a time. **After installing each item, you must reboot the system before moving on to the next item on the list.** The bottom icon with a CD on it allows you to view the entire contents.

Note 2: When making a storage driver diskette by booting into a Driver CD, please set the SATA Configuration to "Compatible Mode" and configure SATA as IDE in the BIOS Setup. After making the driver diskette, be sure to change the SATA settings back to your original settings.

B-2 Installing SuperDoctor5

The Supermicro SuperDoctor® 5 is a hardware monitoring program that functions in a command-line or web-based interface in Windows and Linux operating systems. The program monitors system health information such as CPU temperature, system voltages, system power consumption, fan speed, and provides alerts via email or Simple Network Management Protocol (SNMP).

SuperDoctor 5 comes in local and remote management versions and can be used with Nagios to maximize your system monitoring needs. With SuperDoctor 5 Management Server (SSM Server), you can remotely control power on/off and reset chassis intrusion for multiple systems with SuperDoctor 5 or IPMI. SD5 Management Server monitors HTTP, FTP, and SMTP services to optimize the efficiency of your operation.

 **Note:** The default User Name and Password for SuperDoctor 5 is admin /admin.

SuperDoctor 5 Interface Display Screen (Health Information)



 **Note:** The SuperDoctor 5 program and User's Manual can be downloaded from the Supermicro web site at http://www.supermicro.com/products/nfo/sms_sd5.cfm.

Appendix C

UEFI BIOS Recovery Instructions

Warning: Do not upgrade the BIOS unless your system has a BIOS-related issue. Flashing the wrong BIOS can cause irreparable damage to the system. In no event shall Supermicro be liable for direct, indirect, special, incidental, or consequential damages arising from a BIOS update. If you need to update the BIOS, do not shut down or reset the system while the BIOS is updating to avoid possible boot failure.

C-1 An Overview to the UEFI BIOS

The Unified Extensible Firmware Interface (UEFI) specification provides a software-based interface between the operating system and the platform firmware in the pre-boot environment. The UEFI specification supports an architecture-independent mechanism for add-on card initialization to allow the UEFI OS loader, which is stored in the add-on card, to boot up the system. UEFI offers a clean, hands-off control to a computer system at bootup.

C-2 How to Recover the UEFI BIOS Image (-the Main BIOS Block)

A UEFI BIOS flash chip consists of a recovery BIOS block, comprised of two boot blocks and a main BIOS block (a main BIOS image). The boot block contains critical BIOS codes, including memory detection and recovery codes for the user to flash a new BIOS image if the original main BIOS image is corrupted. When the system power is on, the boot block codes execute first. Once that is completed, the main BIOS code will continue with system initialization and bootup.



Note: Follow the BIOS Recovery instructions below for BIOS recovery when the main BIOS boot crashes.

C-3 To Recover the Main BIOS Block Using a USB-Attached Device

This feature allows the user to recover a BIOS image using a USB-attached device without additional utilities used. A USB flash device such as a USB Flash Drive, or a USB CD/DVD ROM/RW device can be used for this purpose. However, a USB Hard Disk drive cannot be used for BIOS recovery at this time.

To perform UEFI BIOS recovery using a USB-attached device, follow the instructions below.

1. Using a different machine, copy the "Super.ROM" binary image file into the disc Root "\\" Directory of a USB device or a writeable CD/DVD.



Note: If you cannot locate the "Super.ROM" file in your driver disk, visit our website at www.supermicro.com to download the BIOS image into a USB flash device and rename it "Super ROM" for BIOS recovery use.

2. Insert the USB device that contains the new BIOS image ("Super.ROM") into your USB drive and power on the system
3. While powering on the system, keep pressing <Ctrl> and <Home> simultaneously on your keyboard until you hear two short beeps. This may take from a few seconds to one minute.
4. After locating the new BIOS binary image, the system will enter the BIOS Recovery menu as shown below.



Note: At this point, you may decide if you want to start with BIOS Recovery. If you decide to proceed with BIOS Recovery, follow the procedures below.

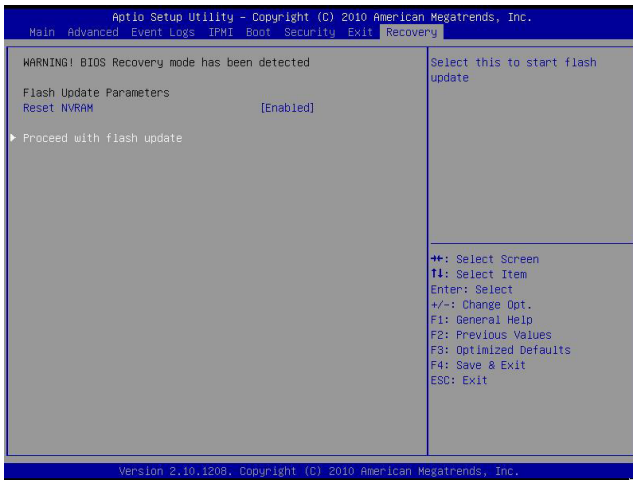

5. When the screen as shown above displays, using the arrow key, select the item- "Proceed with flash update" and press the <Enter> key. You will see the progress of BIOS Recovery as shown in the screen below.



Note: Do not interrupt the process of BIOS flashing until it is completed.

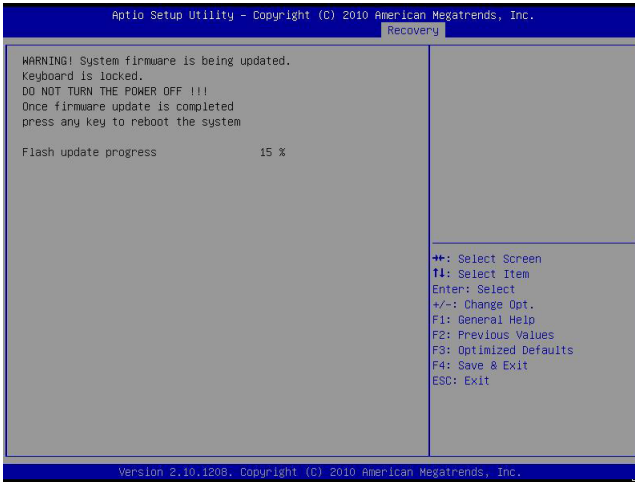

- After the process of BIOS Recovery is complete, press any key to reboot the system.

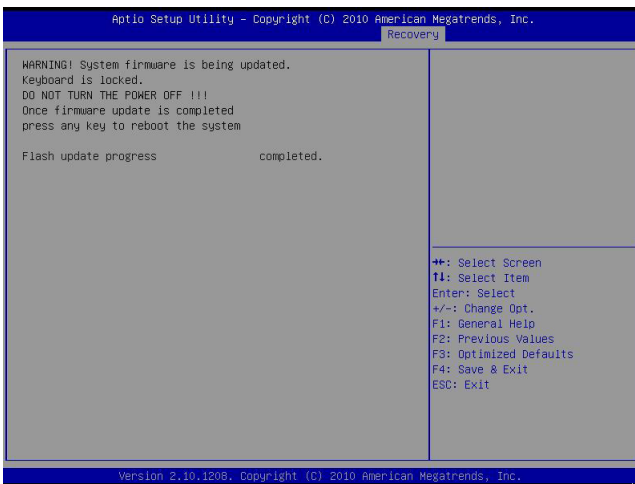

- Using a different system, extract the BIOS package into a bootable USB flash drive.
- When a DOS prompt appears, enter `AMI.BAT BIOSname.###` at the prompt.



Note: Do not interrupt this process until BIOS flashing is completed.

9. After seeing the message that BIOS update is completed, unplug the AC power cable from the power supply to clear CMOS, and then plug the AC power cable in the power supply again to power on the system.
10. Press continuously to enter the BIOS Setup utility.
11. Press <F3> to load default settings.
12. After loading default settings, press <F4> to save the settings and exit the BIOS Setup utility.

Appendix D

Dual Boot Block

D-1 Introduction

This motherboard supports the Dual Boot Block feature, which is the last-ditch mechanism to recover the BIOS boot block. This section provides an introduction to the feature.

BIOS Boot Block

A BIOS boot block is the minimum BIOS loader required to enable necessary hardware components for the BIOS crisis recovery flash that will update the main BIOS block. An on-call BIOS boot-block corruption may occur due to a software tool issue (see image below) or an unexpected power outage during BIOS updates.

```
-----  
                AMI Firmware Update Utility vX.XX.XX  
                Copyright (C)XXXX American Megatrends Inc. All Rights Reserved.  
-----  
Reading flash . . . . . done  
-- ME Data Size checking . ok  
-- FFS checksums . . . . . ok  
Erasing Boot Block . . . . . done  
__ Updating Boot Block . . . . . 0x00A91000 (13%)
```

BIOS Boot Block Corruption Occurrence

When a BIOS boot block is corrupted due to an unexpected power outage or a software tool malfunctioning during BIOS updates, you can still reboot the system by closing pins 2 and 3 using a cap on Jumper JBR1. When JBR1 is set to pins 2 and 3, the system will boot from a backup boot block pre-loaded in the BIOS by the manufacturer.

D-2 Steps to Reboot the System by Using Jumper JBR1

1. Power down the system.
2. Close pins 2-3 on Jumper JBR1, and power on the system.
3. Follow the BIOS recovery SOP listed in the previous chapter (Appendix C).
4. After completing the steps above, power down the system.
5. Close pins 1-2 on Jumper JBR1, and power on the system.

(Disclaimer Continued)

The products sold by Supermicro are not intended for and will not be used in life support systems, medical equipment, nuclear facilities or systems, aircraft, aircraft devices, aircraft/emergency communication devices or other critical systems whose failure to perform be reasonably expected to result in significant injury or loss of life or catastrophic property damage. Accordingly, Supermicro disclaims any and all liability, and should buyer use or sell such products for use in such ultra-hazardous applications, it does so entirely at its own risk. Furthermore, buyer agrees to fully indemnify, defend and hold Supermicro harmless for and against any and all claims, demands, actions, litigation, and proceedings of any kind arising out of or related to such ultra-hazardous use or sale.